

# Elementary Particle Physics: theory and experiments

**The Spontaneous Symmetry Breaking mechanism**

**The Higgs boson hunting at LEP and Tevatron**

**Discovery of the Higgs boson at LHC**

**Measurements: mass, spin, couplings**

**Latest results: Lepton-Photon (January 2022)**

Follow lectures by M. Kado and M. Martinez at HASCO schools.

Slides by E. Di Marco at Lepton-Photon 2021 conference

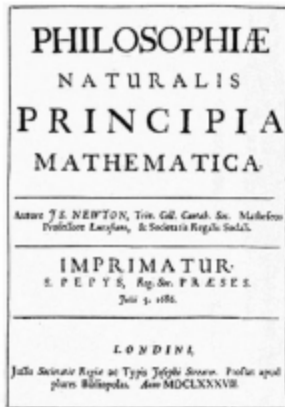

# Not the origin of Mass

- Gallilean and Newtonian concept of mass :

Inertial mass ( $F=ma$ )

Gravitational mass ( $P=mg$ )

Single concept: conserved intrinsic property of matter where the total mass of a system is the sum of its constituents

- Einstein : Does the mass of a system depend of its energy content?

Mass = rest energy of a system or  $m_0=E/c^2$

- Atomic level : binding energy  $\sim O(10\text{eV})$  which is  $\sim 10^{-8}$  of the mass

- Nuclear level (nucleons) : binding energy  $\sim 2\%$  of the mass

- **Nucleon level (partons) : binding energy  $\sim 98\%$  of the mass**

Most of the (luminous) mass in the universe comes from QCD confinement energy

**The insight(s) of the BEH mechanism :**

Making the weak force weak (short range, or W and Z bosons massive)  
and allowing fermion masses in the theory

# Not explaining the flavor Hierarchy

Replacing mass terms by Yukawa couplings

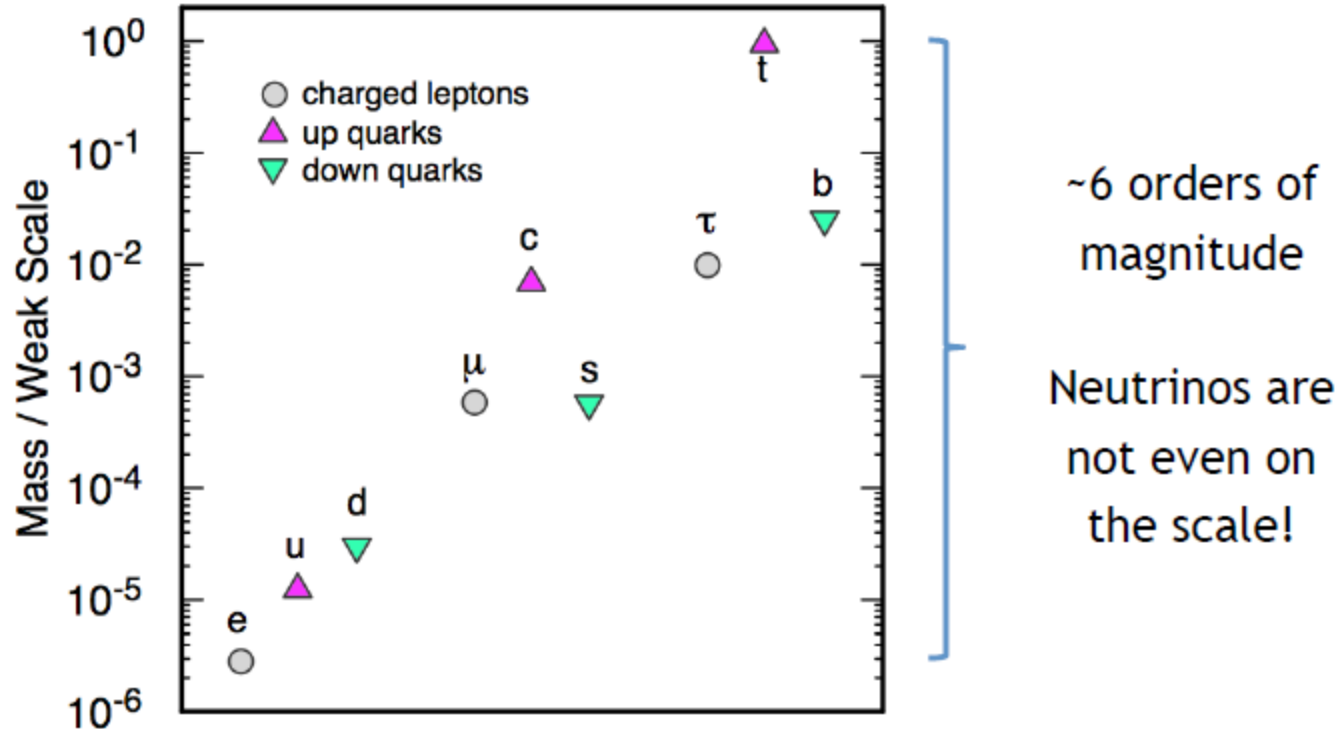

The BEH sector includes most of the free parameters of the Standard Model

# How Would it Be Without Elementary Particle Masses?

Electron mass ( $m_e = 511 \text{ keV}$ )

Bohr Radius  $a = 1/(a_{EM} m_e)$  so :

If  $m_e = 0$  : Then no atomic binding

W boson mass ( $m_W = 81 \text{ GeV}$ )

$$G_F \sim (M_W)^{-2}$$

If no or lower W mass : shorter  
combustion time at lower temperature

Everything would be completely  
different!

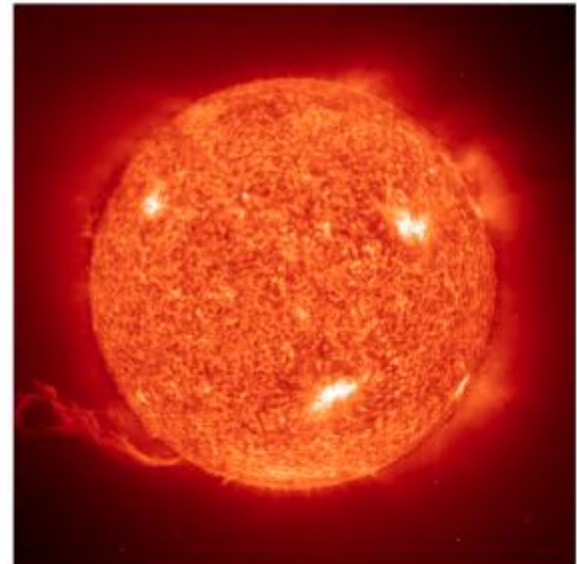
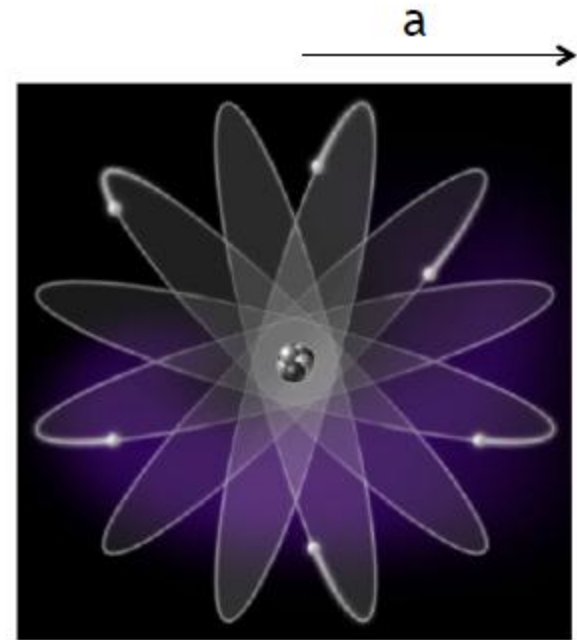

## Historical context and roots of the Standard Model and Higgs Mechanism

1864-1958 - Abelian theory of quantum electrodynamics

1933-1960 - Fermi model of weak interactions

1954 - Yang-Mills theories for gauge interactions...

1957-59 – Schwinger, Bludman and Glashow introduce W bosons for the weak charged currents...

...birth of the idea of unified picture for the electromagnetic and weak interaction in ...

$$SU(2)_L \times U(1)_Y$$

Caution, not unified in the sense of unified forces, only unique framework

... but local gauge symmetry forbids gauge bosons and fermion masses.

# How Does Mass Appear in a Lagrangian

$$m\bar{\psi}\psi$$

In Terms of Feynman Diagram

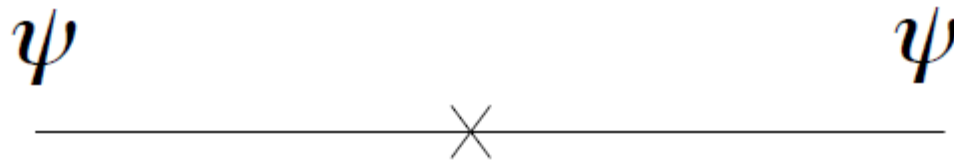

# 1960

## Spontaneous Symmetry Breaking (SSB) - Global Symmetry

The Goldstone theorem is where it all began...

Massless scalars occur in a theory with SSB (or more accurately where the continuous symmetry is not apparent in the ground state).

Originates from the work of Landau (1937)

From a simple (complex) scalar theory with a U(1) symmetry

$$\varphi = \frac{\phi_1 + i\phi_2}{\sqrt{2}} \quad L = \partial_\nu \varphi^* \partial^\nu \varphi - V(\varphi) \quad V(\varphi) = \mu^2 \varphi^* \varphi + \lambda(\varphi^* \varphi)^2$$

The Lagrangian is invariant under :  $\varphi \rightarrow e^{i\alpha} \varphi$

Shape of the potential if  $\mu^2 < 0$  and  $\lambda > 0$  necessary for SSB and be bounded from below.

Change frame to local minimum frame :

$$\varphi = \frac{v + \eta + i\xi}{\sqrt{2}} \quad \text{No loss in generality.}$$
$$L = \frac{1}{2} \underbrace{\partial_\nu \xi \partial^\nu \xi}_{\text{Massless scalar}} + \frac{1}{2} \underbrace{\partial_\nu \eta \partial^\nu \eta + \mu^2 \eta^2}_{\text{Massive scalar}} + \text{interaction terms}$$

Massless scalar

Massive scalar

Nice but what should we do with these massless scalars?

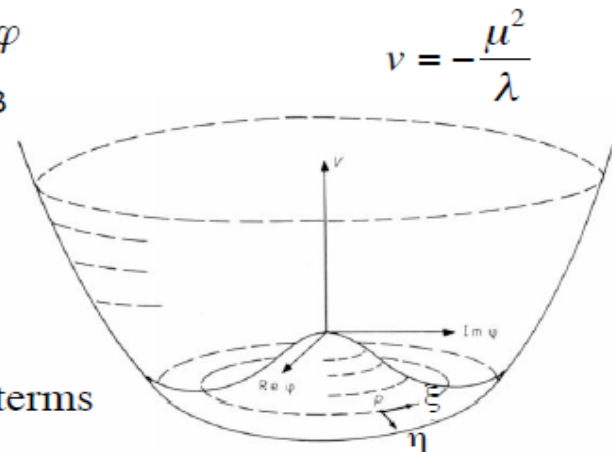

# 1964

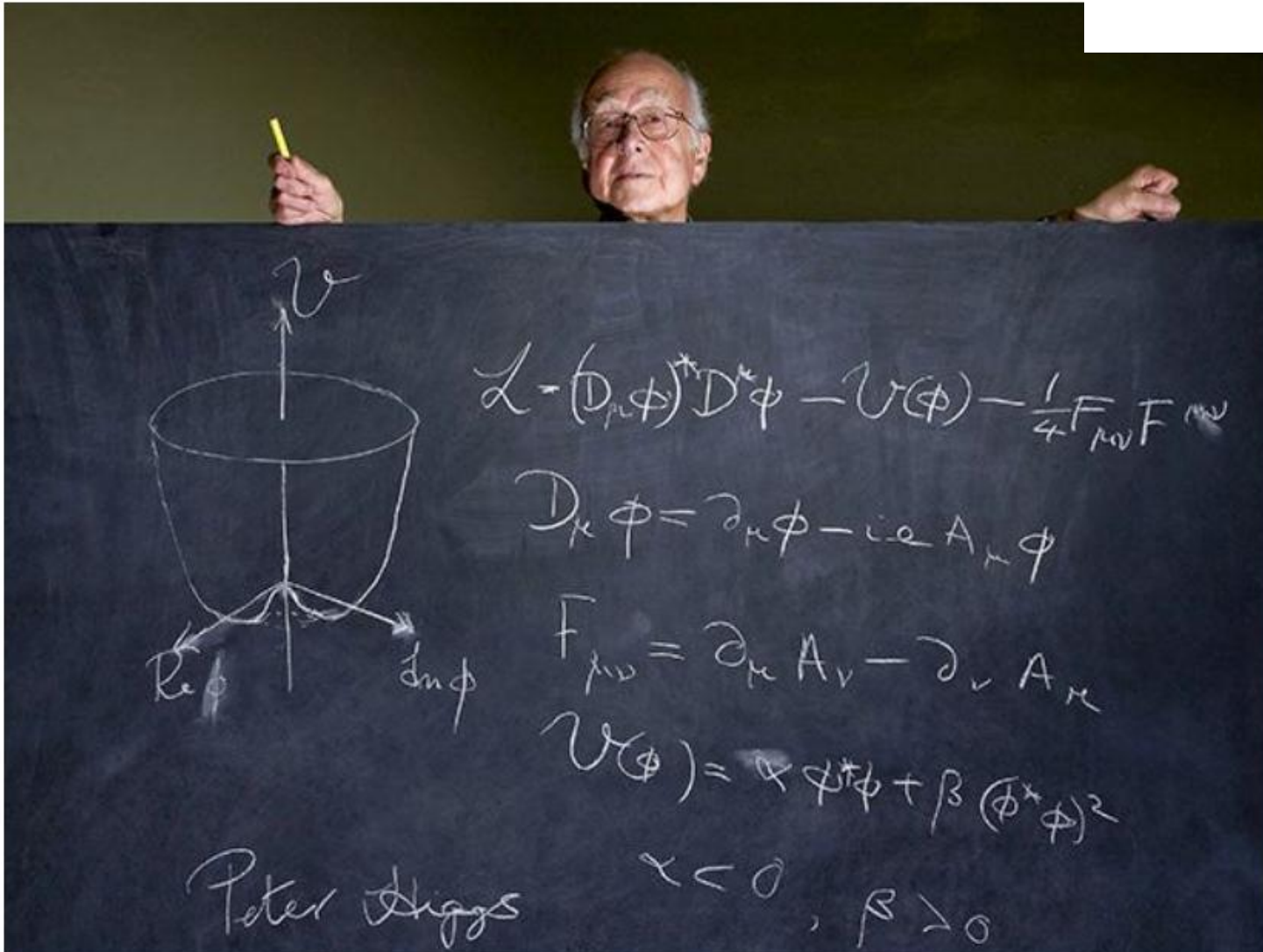



# Spontaneous Symmetry Breaking (SSB) - Local Symmetry

All the players... in the same PRL issue

VOLUME 13, NUMBER 9

PHYSICAL REVIEW LETTERS

31 AUGUST 1964

---

## BROKEN SYMMETRY AND THE MASS OF GAUGE VECTOR MESONS\*

F. Englert and R. Brout

Faculté des Sciences, Université Libre de Bruxelles, Bruxelles, Belgium

(Received 26 June 1964)

2 pages

## BROKEN SYMMETRIES AND THE MASSES OF GAUGE BOSONS

Peter W. Higgs

Tait Institute of Mathematical Physics, University of Edinburgh, Edinburgh, Scotland

(Received 31 August 1964)

1 page

## GLOBAL CONSERVATION LAWS AND MASSLESS PARTICLES\*

G. S. Guralnik,<sup>†</sup> C. R. Hagen,<sup>‡</sup> and T. W. B. Kibble

Department of Physics, Imperial College, London, England

(Received 12 October 1964)

2 pages

1964 - The Higgs mechanism : How gauge bosons can acquire a mass.

## Spontaneous Symmetry Breaking (SSB) Extended to **Local Symmetry**

Let the aforementioned continuous symmetry U(1) be local :  $\alpha(x)$  now depends on the space-time  $x$ .

$$\varphi \rightarrow e^{i\alpha(x)}\varphi$$

The Lagrangian can now be written :  $L = (D_\nu \varphi)^* D^\nu \varphi - V(\varphi) - \frac{1}{4} F_{\mu\nu} F^{\mu\nu}$

In terms of the covariant derivative :  $D_\nu = \partial_\nu - ieA_\nu$

The gauge invariant field strength tensor :  $F^{\mu\nu} = \partial^\mu A^\nu - \partial^\nu A^\mu$

And the Higgs potential :  $V(\varphi) = \mu^2 \varphi^* \varphi + \lambda(\varphi^* \varphi)^2$

Here the gauge field transforms as :  $A_\mu \rightarrow A_\mu + \frac{1}{e} \partial_\mu \alpha$

Again translate to local minimum frame :  $\varphi = \frac{v + \eta + i\xi}{\sqrt{2}}$

$$L = \frac{1}{2} \partial_\nu \xi \partial^\nu \xi + \frac{1}{2} \partial_\nu \eta \partial^\nu \eta + \mu^2 \eta^2 - v^2 \lambda \eta^2 + \frac{1}{2} \underbrace{e^2 v^2 A_\mu A^\mu}_{\text{Mass term}} - ev A_\mu \partial^\mu \xi - F^{\mu\nu} F_{\mu\nu} + \text{ITs}$$

**Mass term for the gauge field! But...**

What about the field content?

A massless Goldstone boson  $\xi$ , a massive scalar  $\eta$  and a massive gauge boson!

Number of d.o.f. :                    1                                    1                                    1

Number of initial d.o.f. :            2                                    **Oooops... Problem!**

But wait! Halzen & Martin p. 326

The term  $evA_\mu\partial^\mu\xi$  is unphysical

The Lagrangian should be re-written using a more appropriate expression of the translated scalar field choosing a particular gauge where  $h(x)$  is real :

$$\varphi = (v + h(x))e^{i\frac{\theta(x)}{v}}$$

Then the gauge transformations are :  $\varphi \rightarrow e^{-i\frac{\theta(x)}{v}}\varphi$        $A_\mu \rightarrow A_\mu + \frac{1}{ev}\partial_\mu\theta$

**Gauge fixed to absorb  $\theta$**

$$L = \frac{1}{2}\partial_\nu h\partial^\nu h - \lambda v^2 h^2 - \lambda v h^3 - \frac{1}{4}\lambda h^4$$

Massive scalar : The Higgs boson

$$+(1/2)e^2 v^2 A_\mu A^\mu - F^{\mu\nu} F_{\mu\nu}$$

Massive gauge boson

$$+(1/2)e^2 A_\mu A^\mu h^2 + ve^2 A_\mu A^\mu h$$

Gauge-Higgs interaction

The Goldstone boson does not appear anymore in the Lagrangian

# 1968

2 pages

## A MODEL OF LEPTONS\*

Steven Weinberg†

Laboratory for Nuclear Science and Physics Department,  
Massachusetts Institute of Technology, Cambridge, Massachusetts

(Received 17 October 1967)

Leptons interact only with photons, and with the intermediate bosons that presumably mediate weak interactions. What could be more natural than to unite<sup>1</sup> these spin-one bosons into a multiplet of gauge fields? Standing in the way of this synthesis are the obvious differences in the masses of the photon and intermediate meson, and in their couplings. We might hope to understand these differences by imagining that the symmetries relating the weak and electromagnetic interactions are exact symmetries of the Lagrangian but are broken by the vacuum. However, this raises the specter of unwanted massless Goldstone bosons.<sup>2</sup> This note will describe a model in which the symmetry between the electromagnetic and weak interactions is spontaneously broken, but in which the Goldstone bosons are avoided by introducing the photon and the intermediate-boson fields as gauge fields.<sup>3</sup> The model may be renormalizable.

We will restrict our attention to symmetry groups that connect the observed electron-type leptons only with each other, i.e., not with muon-type leptons or other unobserved leptons or hadrons. The symmetries then act on a left-handed doublet

$$L = \left[ \frac{1}{2}(1 + \gamma_5) \right] \begin{pmatrix} \nu_e \\ e \end{pmatrix} \quad (1)$$

and on a right-handed singlet

$$R = \left[ \frac{1}{2}(1 - \gamma_5) \right] e. \quad (2)$$

The large  
matic te  
ian cons  
on  $L$ , pl  
right-ha  
as we kn  
tially un  
and the  
gauge fi  
metry w  
massles  
form ou  
spin  $\bar{T}$  a  
+  $\frac{1}{2}N_L$ .

Is this model renormalizable? We usually do not expect non-Abelian gauge theories to be renormalizable if the vector-meson mass is not zero, but our  $Z_\mu$  and  $W_\mu$  mesons get their mass from the spontaneous breaking of the symmetry, not from a mass term put in at the beginning. Indeed, the model Lagrangian we start from is probably renormalizable

Therefore, we shall construct our Lagrangian out of  $L$  and  $R$ , plus gauge fields  $\bar{A}_\mu$  and  $B_\mu$  cou  
blet

Of course our model has too many arbitrary features for these predictions to be taken very seriously

whose  
and  $Y$  and give the electron its mass. The only renormalizable Lagrangian which is invariant under  $\bar{T}$  and  $Y$  gauge transformations is

Milestone PRL 1967

Assuming a third weak gauge boson the initial number of **gauge boson d.o.f. is 8**, to give mass to three gauge bosons at least one doublet of scalar fields is necessary (**4 d.o.f.**) :

$$\phi = \frac{1}{\sqrt{2}} \begin{pmatrix} \phi^+ \\ \phi^0 \end{pmatrix}$$

Setting aside the gauge kinematic terms the Lagrangian can be written :

$$\mathcal{L} = (D_\mu \phi)^\dagger (D^\mu \phi) - V(\phi) \quad \left\{ \begin{array}{l} D_\mu = \partial_\mu - ig\vec{W}_\mu \cdot \vec{\sigma} - ig' \frac{Y}{2} B_\mu \\ V(\phi) = \mu^2 \phi^\dagger \phi + \lambda (\phi^\dagger \phi)^2 \end{array} \right.$$

The next step is to develop the Lagrangian near :  $\langle \phi \rangle = \frac{1}{\sqrt{2}} \begin{pmatrix} 0 \\ v \end{pmatrix}$

**Choosing the specific real direction of charge 0 of the doublet is not fortuitous :**

$$\phi = e^{-i\vec{\sigma} \cdot \vec{\xi}} \frac{1}{\sqrt{2}} \begin{pmatrix} 0 \\ H + v \end{pmatrix} \quad \text{In particular for a non charged vacuum}$$

Again choosing the gauge that will absorb the Goldstone bosons  $\xi \dots$

Then developing the covariant derivative for the Higgs field :

Just replacing the Pauli matrices :

$$D_\mu \varphi = \partial_\mu \varphi - \frac{i}{2} \begin{pmatrix} gW_\mu^3 + g'B_\mu & g(W_\mu^1 - iW_\mu^2) \\ g(W_\mu^1 + iW_\mu^2) & -gW_\mu^3 + g'B_\mu \end{pmatrix} \varphi$$

Then using :  $W_\mu^\pm = \frac{W_\mu^1 \mp iW_\mu^2}{\sqrt{2}}$

$$D_\mu \varphi = \partial_\mu \varphi - \frac{i}{2} \begin{pmatrix} gW_\mu^3 + g'B_\mu & \sqrt{2}gW_\mu^+ \\ \sqrt{2}gW_\mu^- & -gW_\mu^3 + g'B_\mu \end{pmatrix} \varphi = \begin{pmatrix} 0 \\ \partial_\mu h \end{pmatrix} - \frac{i}{2} \begin{pmatrix} \sqrt{2}gvW_\mu^+ + \sqrt{2}ghW_\mu^+ \\ -gvW_\mu^3 + g'vB_\mu - ghW_\mu^3 + g'hB_\mu \end{pmatrix}$$

For the mass terms only :

$$(D_\mu \varphi)^\dagger D^\mu \varphi = \partial_\mu h \partial^\mu h + \frac{1}{4} g^2 v^2 W_\mu^+ W^{-\mu} + \frac{1}{8} \begin{pmatrix} W_\mu^3 & B_\mu \end{pmatrix} \begin{pmatrix} g^2 v^2 & -gg'v^2 \\ -gg'v^2 & g'^2 v^2 \end{pmatrix} \begin{pmatrix} W^{3\mu} \\ B^\mu \end{pmatrix}$$

Explicit mixing of  $W^3$  and  $B$ .

Finally the full Lagrangian will then be written :

$$\begin{aligned}
 \mathcal{L} = & \frac{1}{2} \partial_\mu H \partial^\mu H - \frac{1}{2} \lambda v^2 H^2 - \lambda v H^3 - \frac{\lambda}{4} H^4 && \text{Massive scalar : The Higgs boson} \\
 & + \frac{1}{2} \left[ \frac{g'^2 v^2}{4} B_\mu B^\mu - \frac{gg'v^2}{2} W_\mu^3 B^\mu + \frac{g^2 v^2}{4} \vec{W}_\mu \cdot \vec{W}^\mu \right] && \text{Massive gauge bosons} \\
 & + \frac{1}{v} \left[ \frac{g'^2 v^2}{4} B_\mu B^\mu H - \frac{gg'v^2}{2} W_\mu^3 B^\mu H + \frac{g^2 v^2}{4} \vec{W}_\mu \cdot \vec{W}^\mu H \right] \\
 & + \frac{1}{2v^2} \left[ \frac{g'^2 v^2}{4} B_\mu B^\mu H^2 - \frac{gg'v^2}{2} W_\mu^3 B^\mu H^2 + \frac{g^2 v^2}{4} \vec{W}_\mu \cdot \vec{W}^\mu H^2 \right] && \left. \begin{array}{l} \text{Gauge-Higgs} \\ \text{interaction} \end{array} \right\}
 \end{aligned}$$

In order to derive the mass eigenstates :

Diagonalize the mass matrix  $\frac{1}{4} \begin{pmatrix} g^2 v^2 & -gg'v^2 \\ -gg'v^2 & g'^2 v^2 \end{pmatrix} = \mathcal{M}^{-1} \begin{pmatrix} m_Z^2 & 0 \\ 0 & 0 \end{pmatrix} \mathcal{M}$

Where

$$\mathcal{M} = \begin{pmatrix} \cos \theta_W & -\sin \theta_W \\ \sin \theta_W & \cos \theta_W \end{pmatrix} \quad \sin \theta_W = \frac{g'}{\sqrt{g^2 + g'^2}} \quad \cos \theta_W = \frac{g}{\sqrt{g^2 + g'^2}}$$

The Weinberg angle was actually first introduced by Glashow (1960)



## The sector of Fermions (kinematic)

Another important consequence of the Weinberg Salam Model...

A specific  $SU(2)_L \times U(1)_Y$  problem :  $m\bar{\psi}\psi$  manifestly not gauge invariant

$$m\bar{\psi}\psi = m\bar{\psi}\left(\frac{1}{2}(1-\gamma^5) + \frac{1}{2}(1+\gamma^5)\right)\psi = m(\bar{\psi}_L\psi_R + \bar{\psi}_R\psi_L)$$

- neither under  $SU(2)_L$  doublet and singlet terms together
- nor under  $U(1)_Y$  do not have the same hypercharge

Fermion mass terms are forbidden

Not the case for Yukawa couplings to the Higgs doublet

Then after SSB one recovers :

$$\frac{\lambda_\psi v}{\sqrt{2}}\bar{\psi}\psi + \frac{\lambda_\psi}{\sqrt{2}}H\bar{\psi}\psi$$

Which is invariant under  $U(1)_{EM}$

Very important : **The Higgs mechanism DOES NOT predict fermion masses**  
...Yet the coupling of the Higgs to fermions is proportional to their masses



But wait...

The coupling to the Higgs fields is the following :

$$\lambda_d(\bar{u}_L, \bar{d}_L) \begin{pmatrix} 0 \\ v+h \end{pmatrix} d_R + H.C. = \lambda_d \bar{Q}_L \phi d_R$$

Can be seen as giving mass to down type fermions...

To give mass to up type fermions, need to use a slightly different coupling :

$$\phi^C = i\sigma_2 \phi^* \quad \lambda_u \bar{Q}_L \phi^C \bar{u}_R = \lambda_u(\bar{u}_L, \bar{d}_L) \begin{pmatrix} v+h \\ 0 \end{pmatrix} d_R + H.C.$$

One doublet of complex scalar fields is sufficient to accommodate mass terms for gauge bosons and fermions !

... But not necessarily only one!

## Gauge-Higgs and interactions

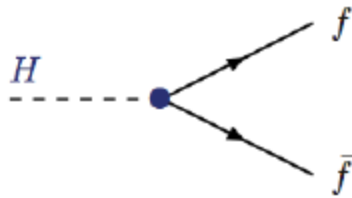

$$g_{Hff} = m_f/v$$

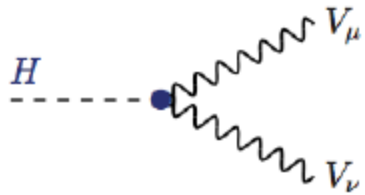

$$g_{HVV} = 2M_V^2/v$$

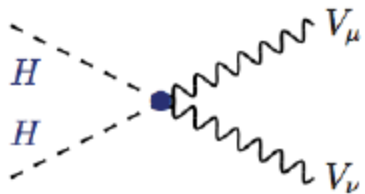

$$g_{HHVV} = 2M_V^2/v^2$$

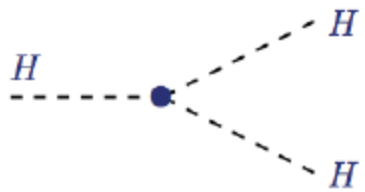

$$g_{HHH} = 3M_H^2/v$$

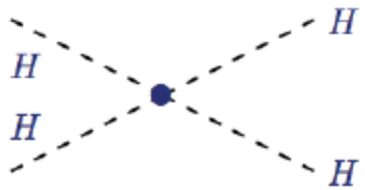

$$g_{HHHH} = 3M_H^2/v^2$$

More directly testable relations!

# Prediction of the Model

Beside the existence of the Z massive neutral gauge boson...

The existence of a massive scalar :

## The Higgs Particle

Whose mass (as  $\lambda$ ) was an unknown parameter of the theory

$$v = -\frac{\mu^2}{\lambda}$$

The first very important consequences of this mechanism :

1.- Two massive charged vector bosons :

$$m_W^2 = \frac{g^2 v^2}{4}$$

Corresponding to the observed charged currents

Thus  $v = 246$  GeV

Given the known W mass and g coupling

2.- One massless vector boson :  $m_\gamma = 0$

The photon corresponding to the unbroken  $U(1)_{EM}$

3.- One massive neutral vector boson Z :

$$m_Z^2 = (g^2 + g'^2)v^2/4$$

4.- One massive scalar particle : **The Higgs boson**

Whose mass is an unknown parameter of the theory as the quartic coupling  $\lambda$

$$m_H^2 = \frac{4\lambda(v)m_W^2}{g^2}$$

Which of these consequences are actually predictions ?

- 1.- The theory was chosen in order to describe the weak interactions mediated by charged currents.
- 2.- The masslessness of the photon is a consequence of the choice of developing the Higgs field in the neutral and real part of the doublet.
- 3 & 4.- The appearance of massive Z and Higgs bosons are actually predictions of the model.

One additional very important prediction which was not explicitly stated in Weinberg's fundamental paper... although it was implicitly clear :

There is a relation between the ratio of the masses and that of the couplings of gauge bosons :

$$\frac{M_W}{M_Z} = \frac{g^2}{g^2 + g'^2} = \cos^2 \theta_W$$

or

$$\rho \equiv \frac{m_W^2}{m_Z^2 \cos^2 \theta_W} = 1$$

# Absolute Lower Limit on the Higgs Mass at LEP

LEP1  $e^+e^-$  at COM  $\sim m_Z$

Various decays and topologies

Limit down to below  $2m_e$  using acoplanar lepton pairs (Higgs is long lived)

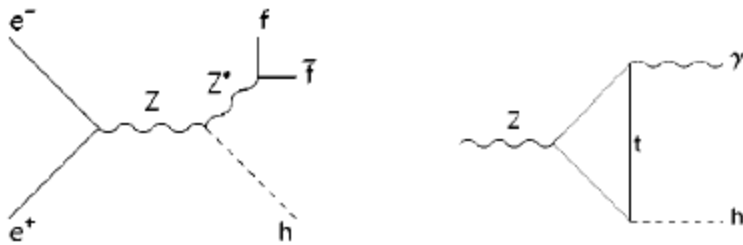

LEP2  $e^+e^-$  up to 209 GeV

(mostly  $b\bar{b}$  and  $\tau\tau$  decays)

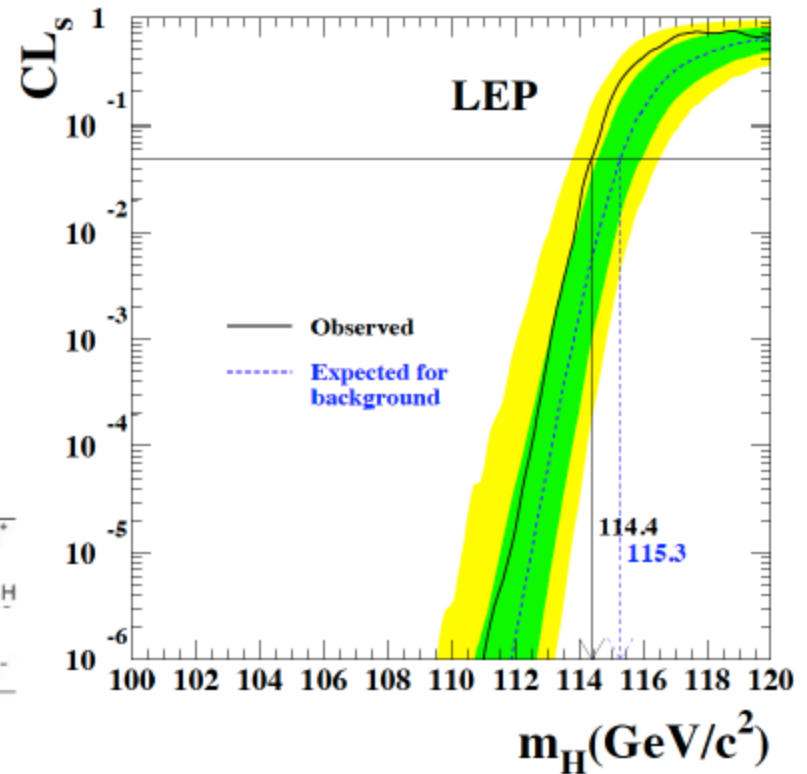
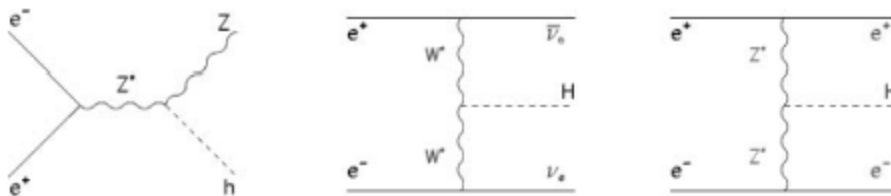

**Excludes SM Higgs with mass below 114 GeV**

# Electroweak Precision Data and the Higgs Mass

## *The famous blue band plot!*

Fermi Constant  $G_F = 1.166367(5) \times 10^{-5} \text{ GeV}^{-2}$  (muon lifetime)

Fine structure Constant  $\alpha = 1/137.035999679(94)$  (quantum Hall effect)

Z mass  $M_Z = 91.1876 \pm 0.0021 \text{ GeV}$  (LEP)

$$G_F = \frac{\pi\alpha_{QED}}{\sqrt{2}m_W^2(1 - m_W^2/m_Z^2)}(1 + \Delta r)$$

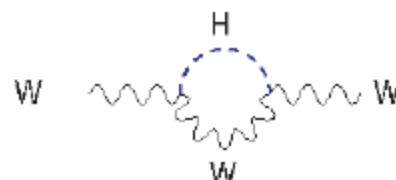

Measurement	Fit	$ \sigma^{\text{meas}} - \sigma^{\text{fit}} /\sigma^{\text{meas}}$
$\Delta\alpha_{\text{had}}^{(5)}$	$0.02750 \pm 0.00033$	0.02759
$m_Z$ [GeV]	$91.1875 \pm 0.0021$	91.1874
$\Gamma_Z$ [GeV]	$2.4952 \pm 0.0023$	2.4959
$\sigma_{\text{had}}^e$ [nb]	$41.540 \pm 0.037$	41.478
$R_l$	$20.767 \pm 0.025$	20.742
$A_{\text{FB}}^{(l)}$	$0.01714 \pm 0.00095$	0.01645
$A_1(P_e)$	$0.1465 \pm 0.0032$	0.1481
$R_b$	$0.21629 \pm 0.00066$	0.21579
$R_c$	$0.1721 \pm 0.0030$	0.1723
$A_{\text{FB}}^{(b)}$	$0.0992 \pm 0.0016$	0.1038
$A_{\text{FB}}^{(c)}$	$0.0707 \pm 0.0035$	0.0742
$A_b$	$0.923 \pm 0.020$	0.935
$A_c$	$0.670 \pm 0.027$	0.668
$A_1(\text{SLD})$	$0.1513 \pm 0.0021$	0.1481
$\sin^2\theta_{\text{eff}}^e(Q_e)$	$0.2324 \pm 0.0012$	0.2314
$m_W$ [GeV]	$80.385 \pm 0.015$	80.377
$\Gamma_W$ [GeV]	$2.085 \pm 0.042$	2.092
$m_t$ [GeV]	$173.20 \pm 0.90$	173.26

$$\Delta r \propto \log\left(\frac{m_H}{m_W}\right)$$

$$m_H = 94_{-24}^{+29} \text{ GeV}$$

*Is there a Higgs?*

$m_H < 152 \text{ GeV}$  at 95% CL

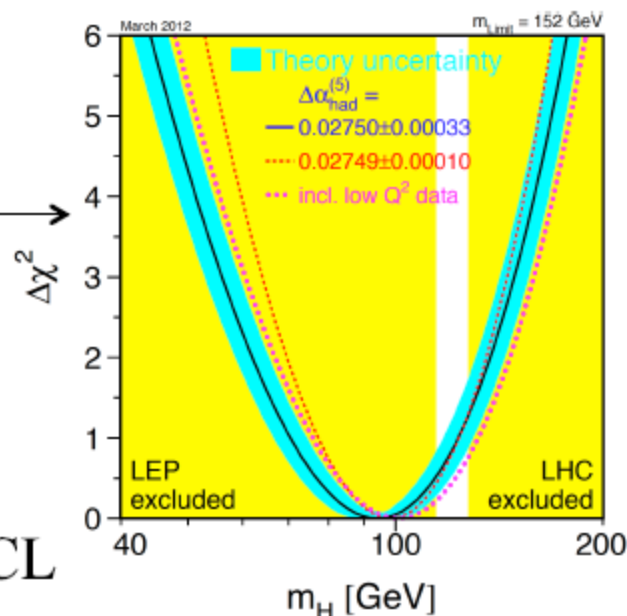





# Tevatron

Chicago



$$\sqrt{s} = 1.96 \text{ TeV}$$



Booster

CDF

DØ

Tevatron

p-bar source

Main Injector  
(new)

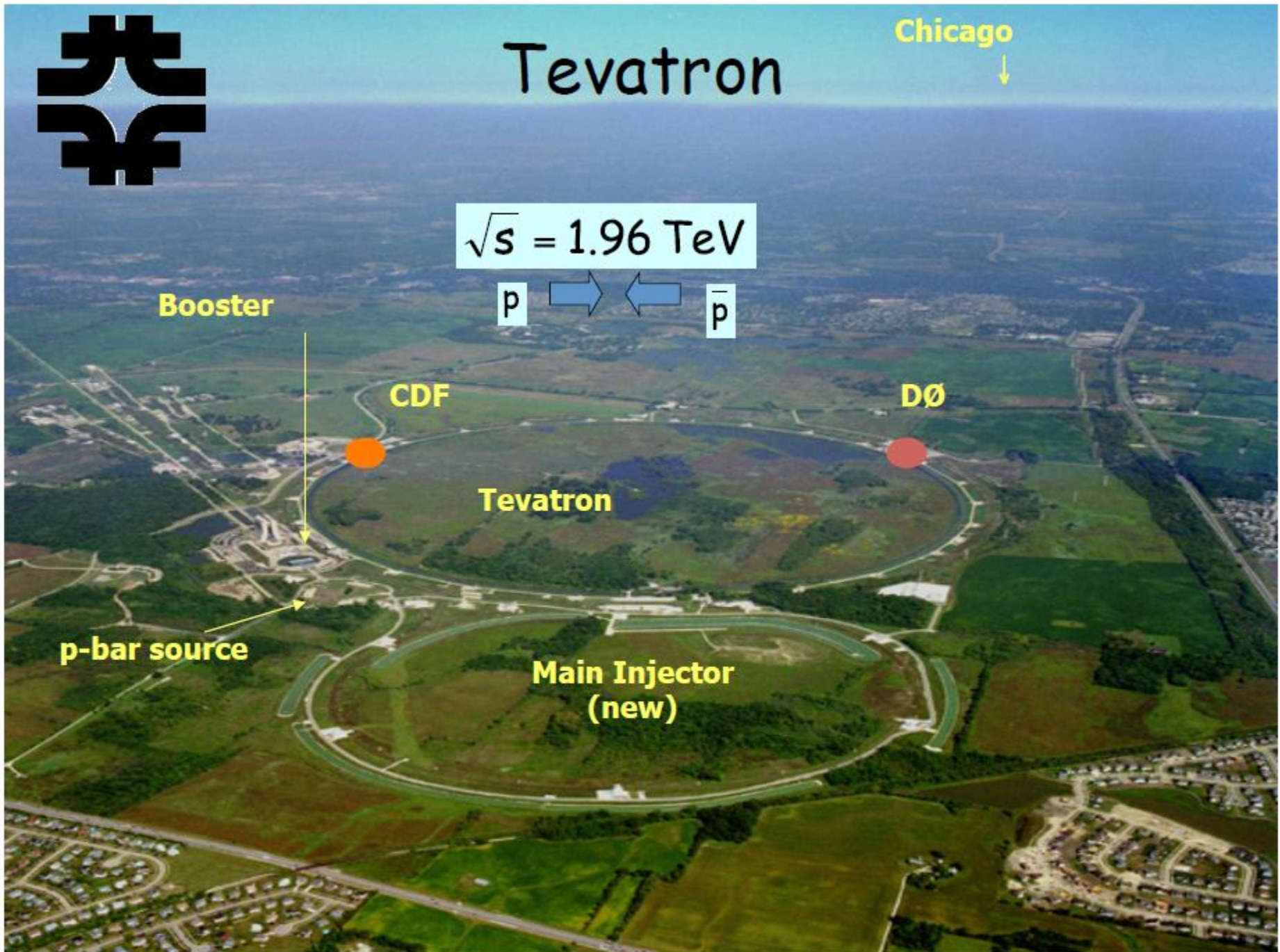



$qq \rightarrow WH, ZH$

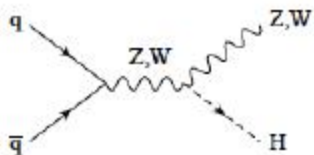

# Tevatron in July 2010



Tevatron Run II Preliminary,  $\langle L \rangle = 5.9 \text{ fb}^{-1}$

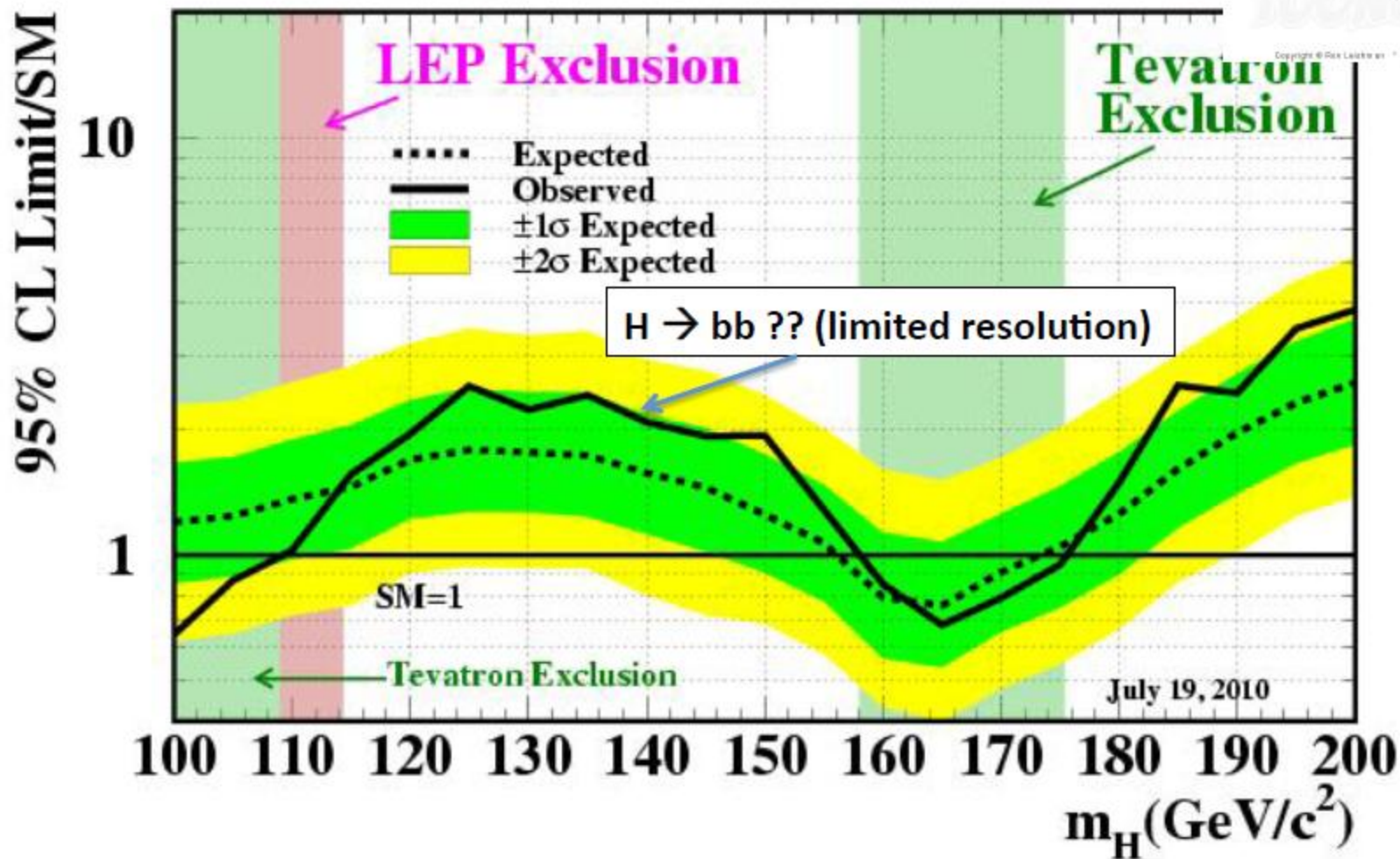

If goes below 1 you exclude the SM Higgs for a given mass



**CERN (Geneva) LHC across the France-Switzerland border**

**Approved in 1994**

27 Km

1232 high-tech superconducting dipole magnets  
(at 1.8 K...the coldest **(and coolest)** place in the universe)

proton – proton 7-8 TeV in Run I (2010 – 2012)  
(13 TeV in Run II) (2015 -- 2018)

**13.6 TeV in Run III (2022 - 2025?)**



# Shown here results based on Run I

## Energy frontier

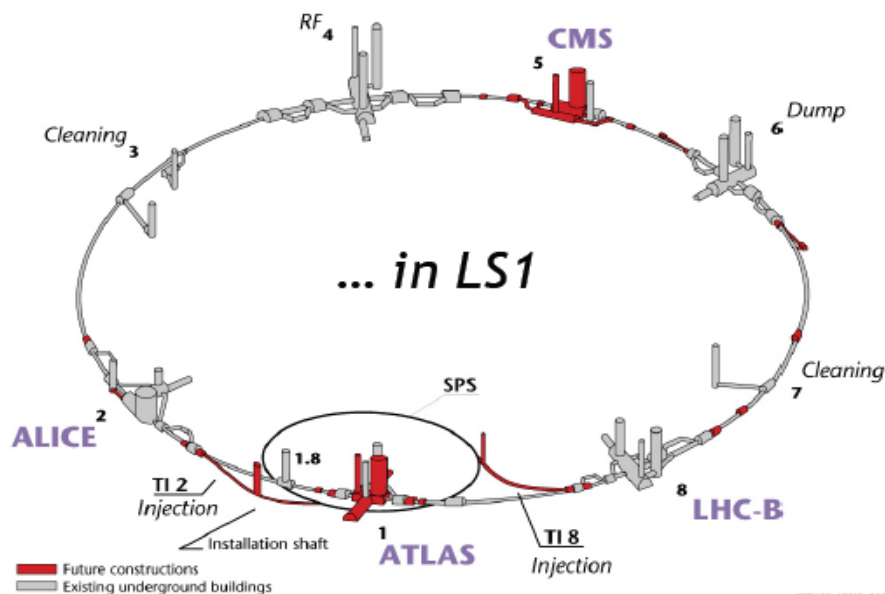

### The LHC

- Circumference 27 km
- Up to 175 m underground
- Total number of magnets 9 553
- Number of dipoles 1 232
- Operation temperature 1.9 K (Superfluid He)

$$\mathcal{L} = \frac{N_p^2 k_b f_{rev} \gamma}{4\pi \beta^* \epsilon_n} F$$

Parameter	2010	2011	2012	Nominal
C.O.M Energy	7 TeV	7 TeV	8 TeV	14 TeV
Bunch spacing / k	150 ns / 368	50 ns / 1380	50 ns / 1380	25 ns / 2808
$\epsilon$ (mm rad)	2.4-4	1.9-2.3	2.5	3.75
$\beta^*$ (m)	3.5	1.5-1	0.6	0.55
L (cm <sup>-2</sup> s <sup>-1</sup> )	2x10 <sup>32</sup>	3.3x10 <sup>33</sup>	~7x10 <sup>33</sup>	10 <sup>34</sup>

# The first LHC run

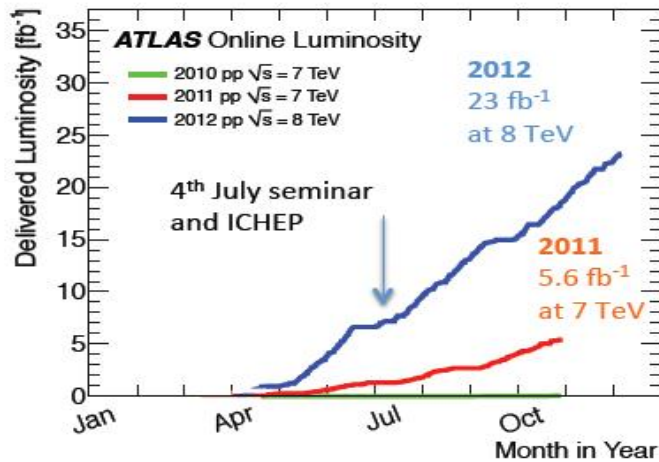

**2010**  
O(2) Pile-up events  
150 ns inter-bunch spacing

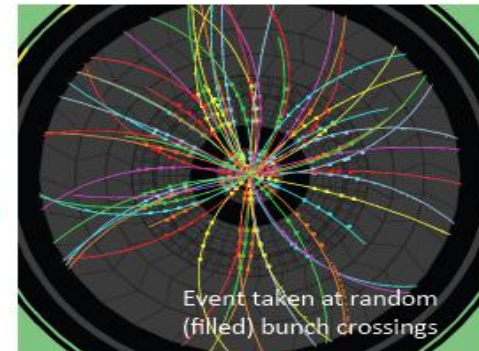

**2010**  
0.05 fb<sup>-1</sup>  
at 7 TeV

**2011**  
O(10) Pile-up events  
50 ns inter-bunch spacing

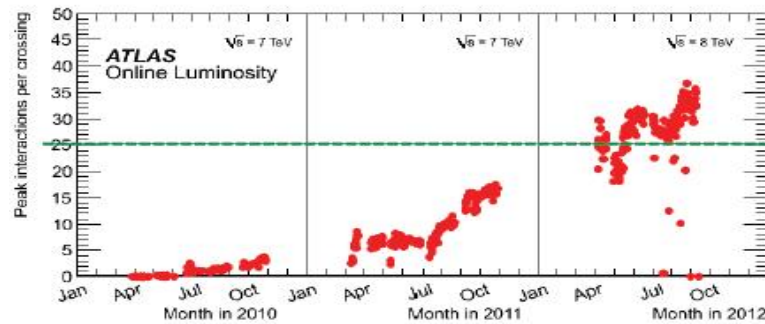
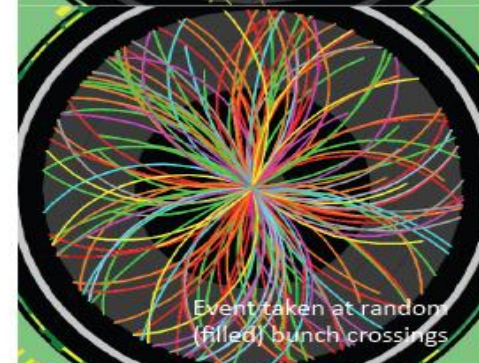

**2012**  
O(20) Pile-up events  
50 ns inter-bunch spacing



# Local $p_0$

Probability that the background can produce a fluctuation greater than or equal to the excess observed in data. Equivalent in terms of number of standard deviations is called local significance.

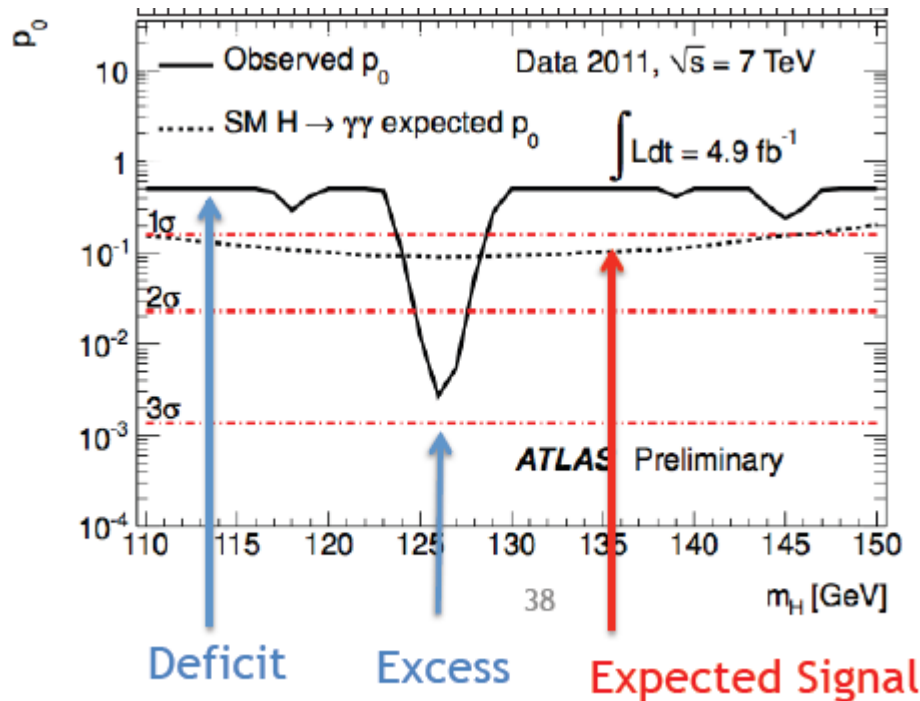

# Birth of a particle

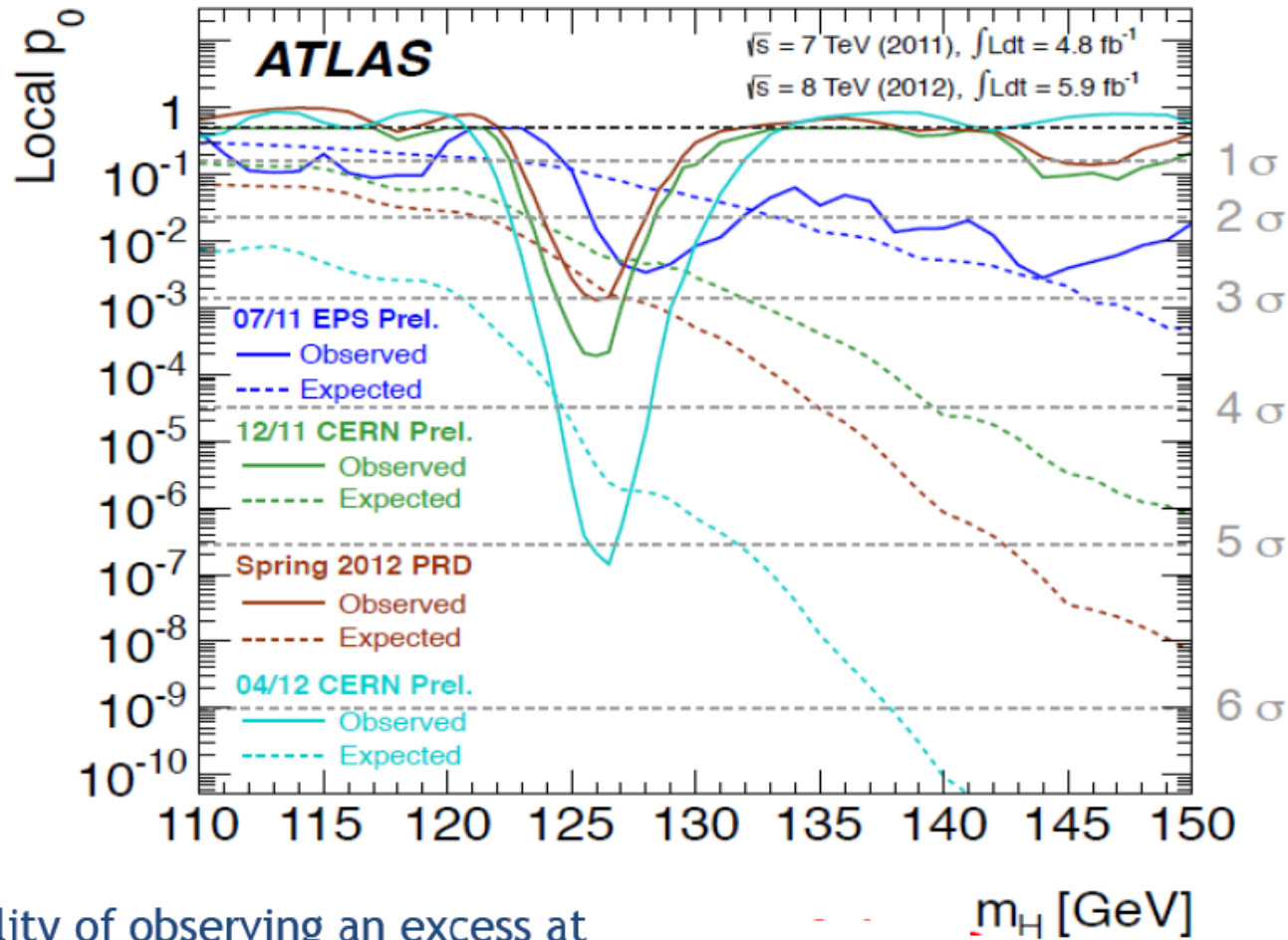

Probability of observing an excess at  
 one specific mass  
 (in absence of signal)...

# Higgs-like particle – 4 July 2012

Phys.Lett. B716 (2012) 1-29

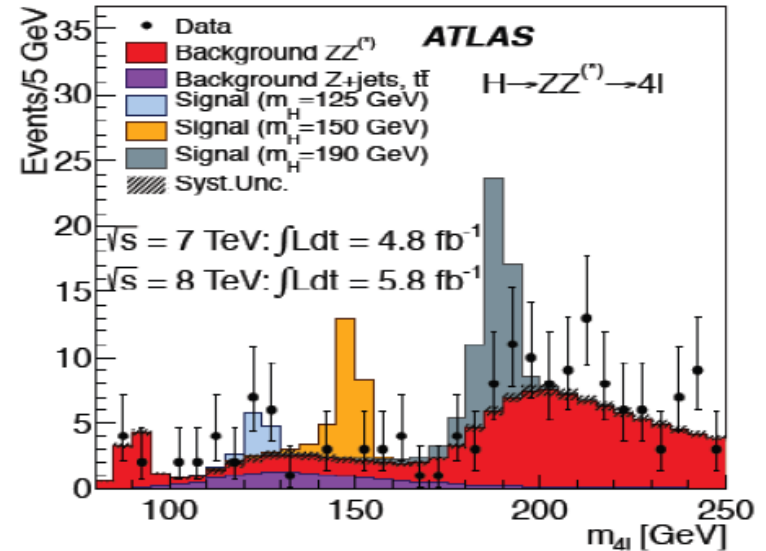
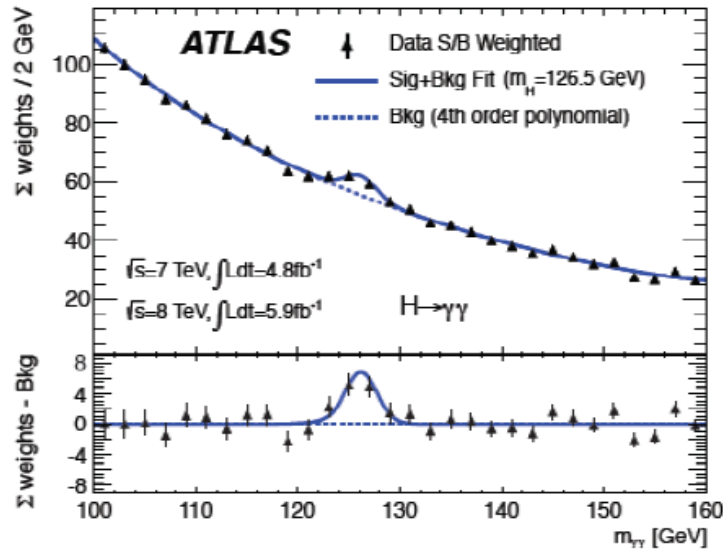

Phys.Lett. B716 (2012) 30-61

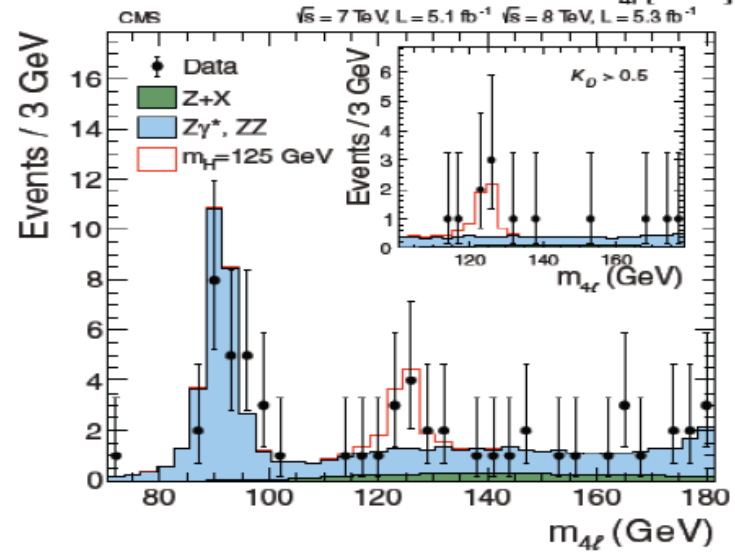
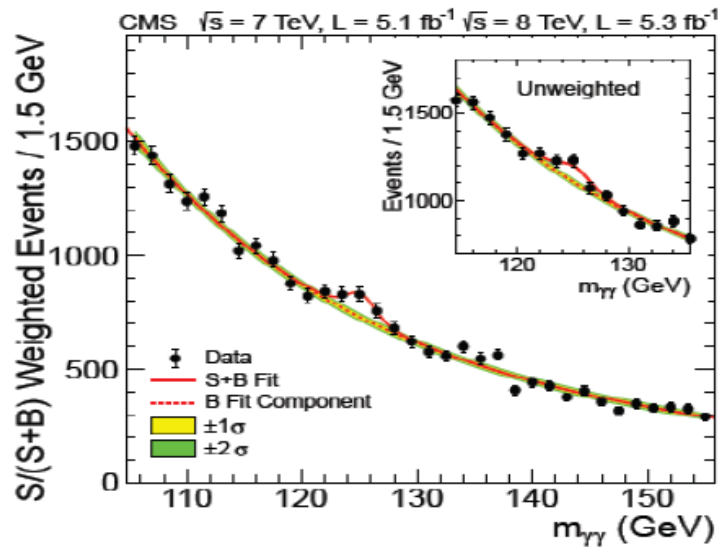



# Higgs-like particle – 4 July 2012

- We are living in a privileged moment in the history of High Energy Physics: **first fundamental scalar**
- The discovery came at half of the design energy, much more severe pile-up and one-third of integrated luminosity than was originally judged as

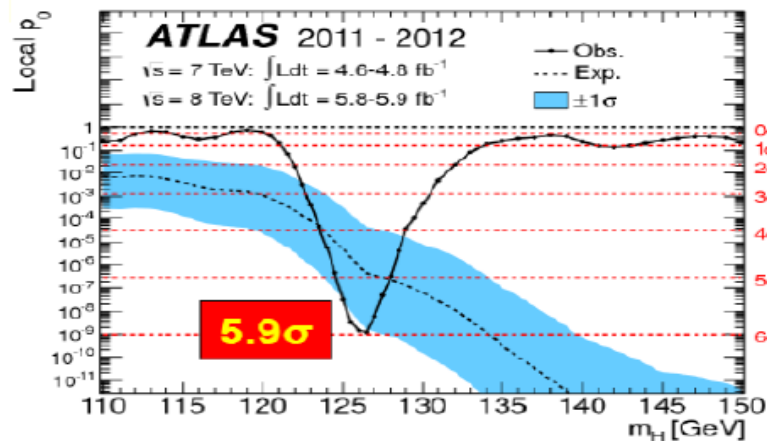

**ATLAS** [PLB 716 \(2012\) 1-29](#), Sept 17 (2012)

**Largest local excess:**  
**5.9σ at  $m_H = 126.5$  GeV**

$H \rightarrow \gamma\gamma, bb, \tau\tau, WW(l\nu l\nu, l\nu q\bar{q}), ZZ(4l, ll\nu\nu, llq\bar{q})$

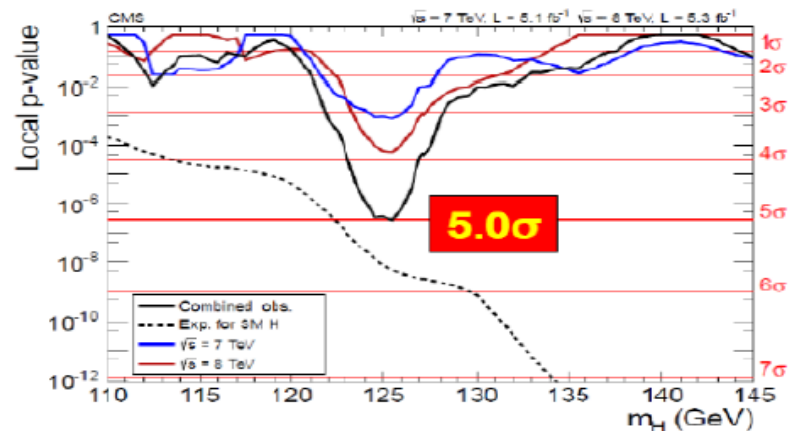

**CMS** [PLB 716 \(2012\) 30-61](#), Sept 17 (2012)

**Largest local excess:**  
**5.0σ at  $m_H = 125.5$  GeV**

$H \rightarrow \gamma\gamma, bb, \tau\tau, WW(l\nu l\nu), ZZ(4l, ll\tau\tau, ll\nu\nu, llq\bar{q})$



# The Higgs Boson at the LHC

## Production

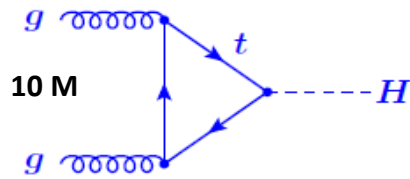

Main production channel

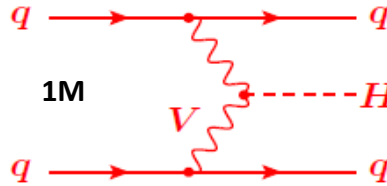

2 forward jets,  
little central  
hadronic activity

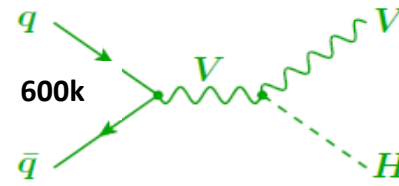

Tag W and Z  
decays

#Higgs produced at  
13 TeV (2015-2017)

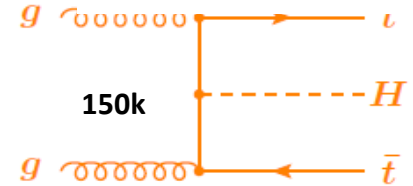

Tag 2 top quarks

## Decays

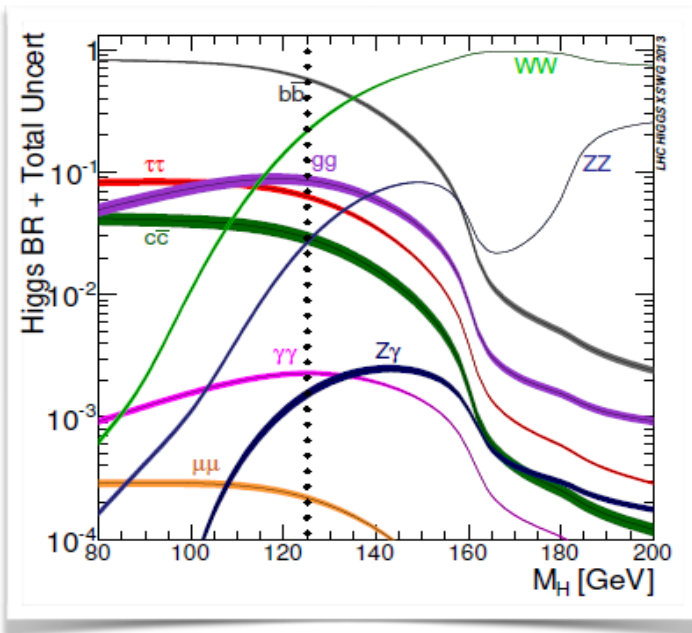

## 5 main channels at the LHC

Decay branching fractions for  
 $m_H = 125 \text{ GeV}$

- $H \rightarrow bb$ : 58 %
- $H \rightarrow WW^*$ : 21%
- $H \rightarrow \tau^+\tau^-$ : 6.3%
- $H \rightarrow ZZ^*$ : 2.6%
- $H \rightarrow \gamma\gamma$ : 0.2%

# Higgs boson couplings

*Gauge bosons*

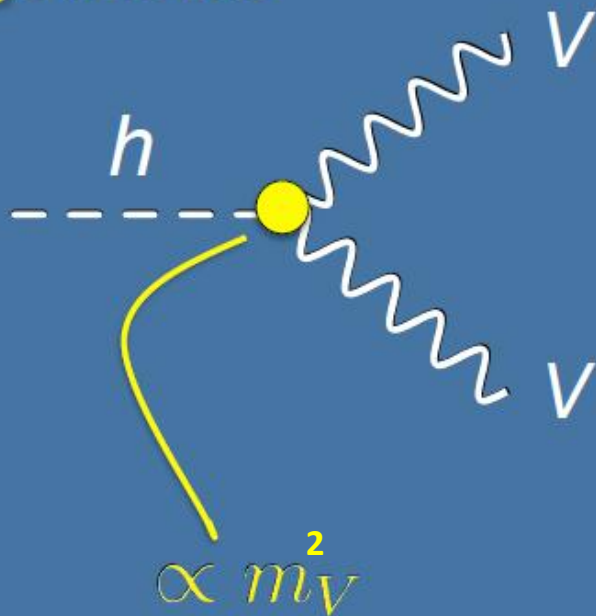

*Fermions*

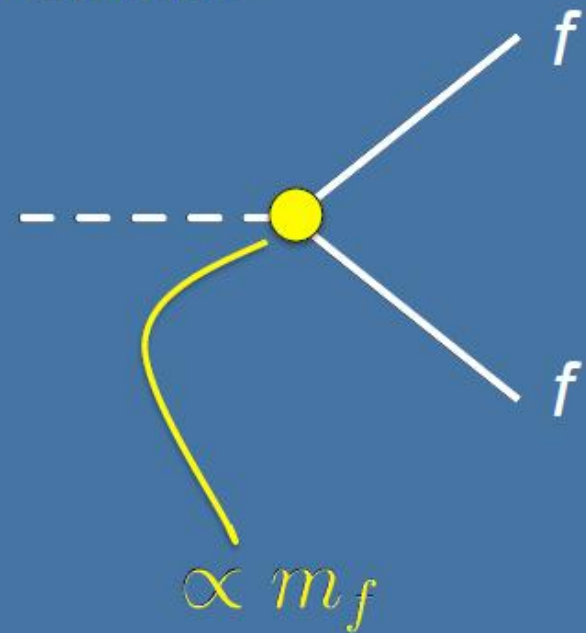

Higgs boson properties are fixed in the Standard Model ( $m_h$ )

# Higgs boson phenomenology

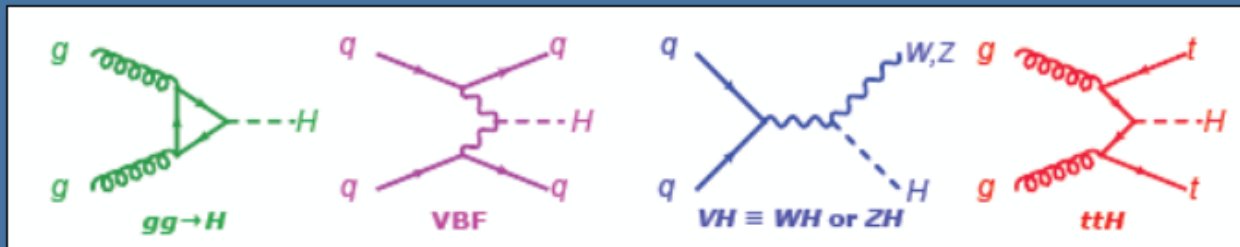

'production & decay matrix'  
sensitivity to different Higgs properties

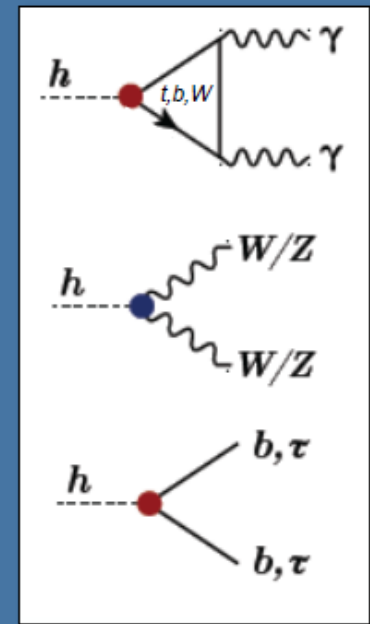

# H- $\rightarrow\gamma\gamma$ : events signature

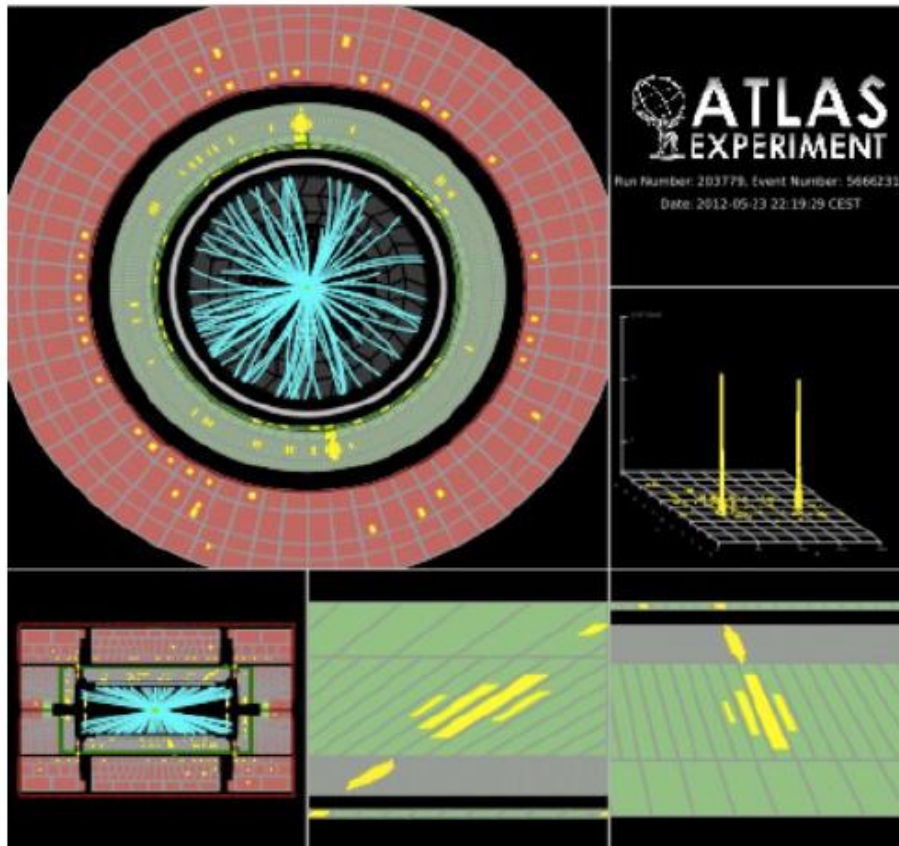

## *Simple event signature*

- Two high  $p_T$  photons  
 $p_{T_1} > 40$  GeV and  $p_{T_2} > 30$  GeV
- High trigger efficiency  
 $\sim 99\%$
- High event selection efficiency  
despite high jet-jet &  $\gamma$ -jet  
production  
 $\sim 40\%$
- High signal over background  
 $\sim 3-10\%$  (depending on sub-category)

Invariant mass reconstruction  $m_{\gamma\gamma}^2 = 2 * E_1 E_2 (1 - \cos \alpha)$

- Good energy calibration
- Robust primary vertex reconstruction

$\rightarrow$  Excellent invariant mass resolution  $\sim 1.6$  GeV with 90% of events within  $\pm 2\sigma$



# Shower shapes and vertex reconstr.

## Photon ID 2 – Photon shower shapes and background rejection

$\pi^0$ - $\gamma$  Rejection

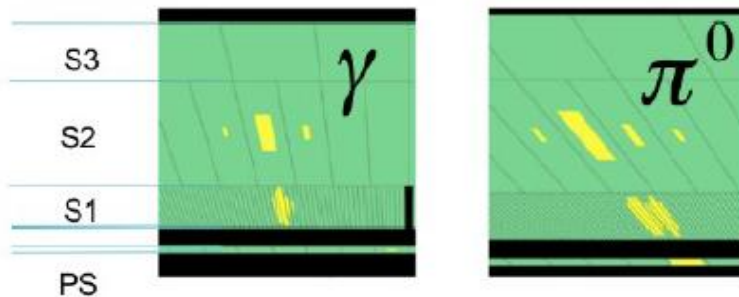

- Photons shower shape distributions in LAr sampling layers - different for signal and background ( $\pi^0$ )

## Vertex Reconstruction

$$m_{\gamma\gamma}^2 = 2 * E_1 E_2 (1 - \cos \alpha)$$

□ Vertex reconstructed through likelihood combination

- Calorimeter 'pointing'
- $\Sigma$  tracks  $pT^2$
- Conversion vertex
- Mean vertex position

Calo pointing

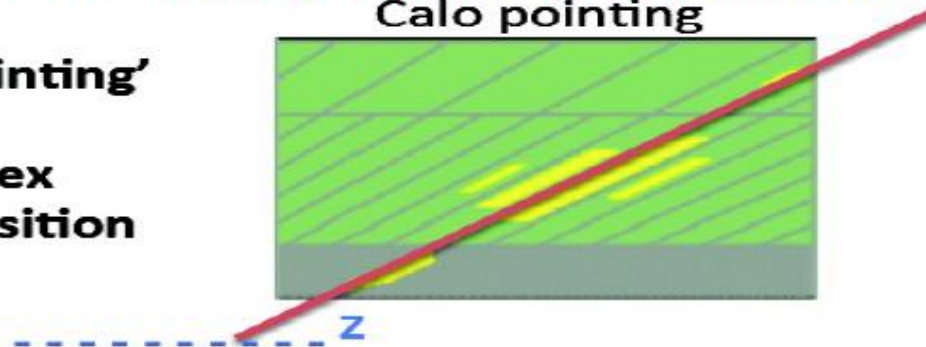

# H- $\rightarrow\gamma\gamma$ : background rejection

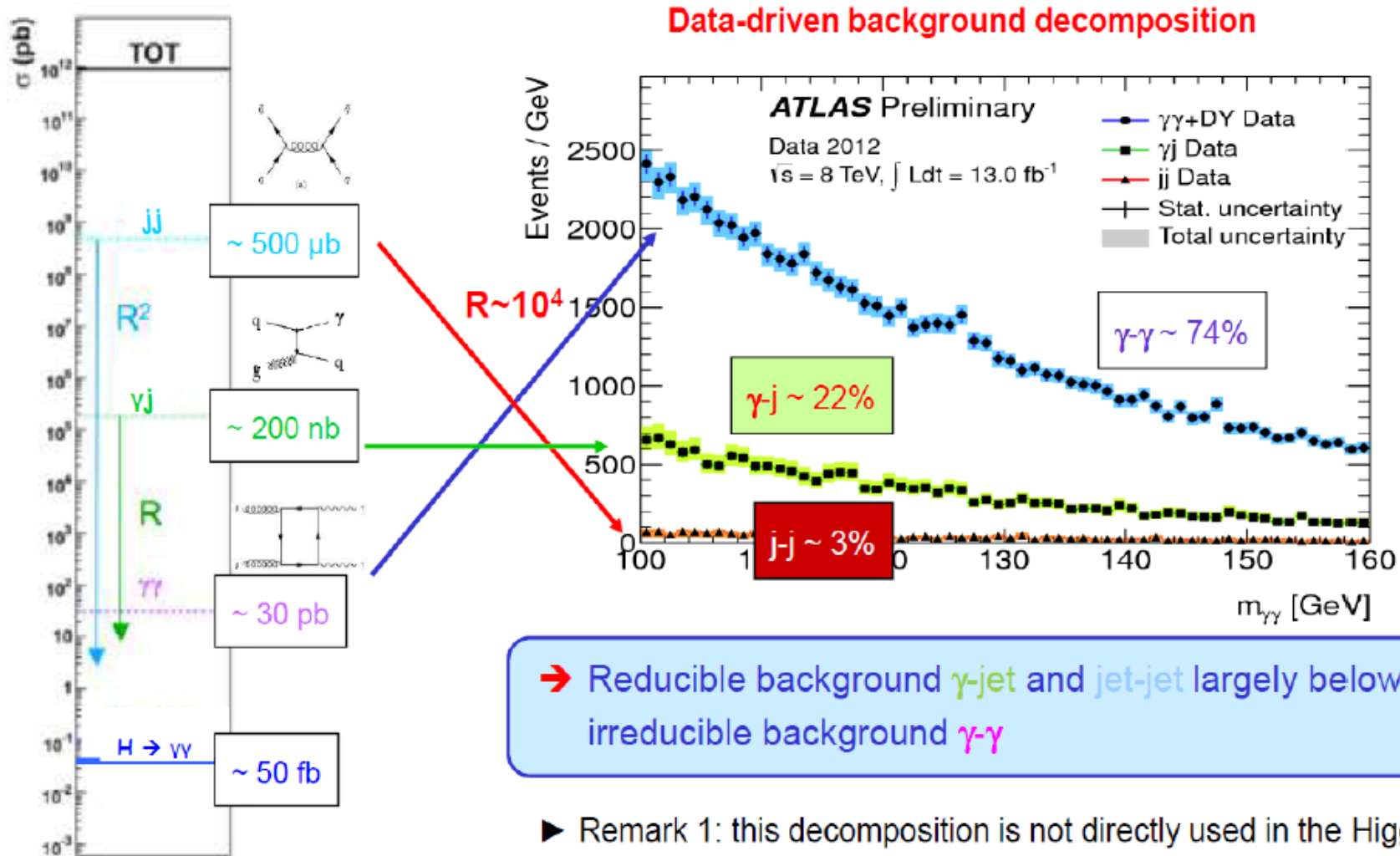

➔ Reducible background  $\gamma\text{-jet}$  and  $\text{jet-jet}$  largely below irreducible background  $\gamma\text{-}\gamma$

- ▶ Remark 1: this decomposition is not directly used in the Higgs search: the background is extrapolated from data sidebands
- ▶ Remark 2: Drell-Yan  $\sim$ negligible for  $m_{\gamma\gamma} > 100 \text{ GeV}$  ( $\sim 1\%$ )

# The golden channel: $H \rightarrow ZZ, Z \rightarrow ll$

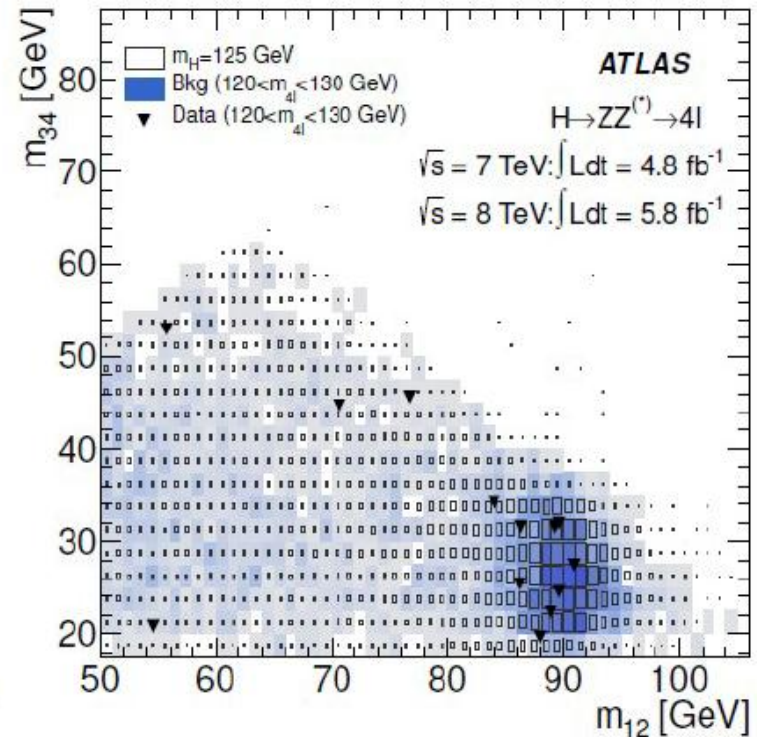
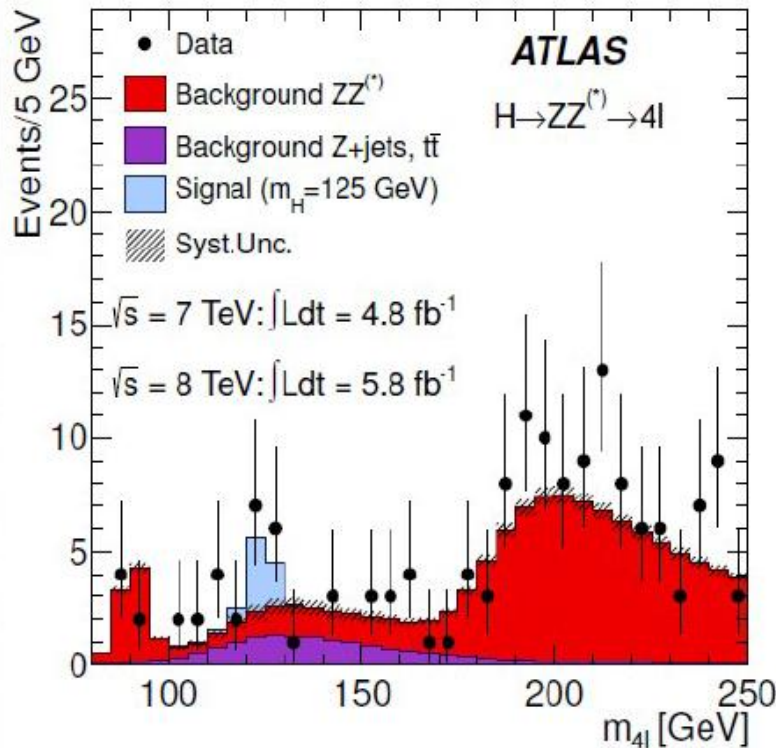

In a  $m_{4l}$  window  
 around 120-130 GeV:

	Signal	$ZZ^{(*)}$	$Z + \text{jets}, t\bar{t}$	Observed
$4\mu$	$2.09 \pm 0.30$	$1.12 \pm 0.05$	$0.13 \pm 0.04$	6
$2e2\mu/2\mu2e$	$2.29 \pm 0.33$	$0.80 \pm 0.05$	$1.27 \pm 0.19$	5
$4e$	$0.90 \pm 0.14$	$0.44 \pm 0.04$	$1.09 \pm 0.20$	2

# Signal and background

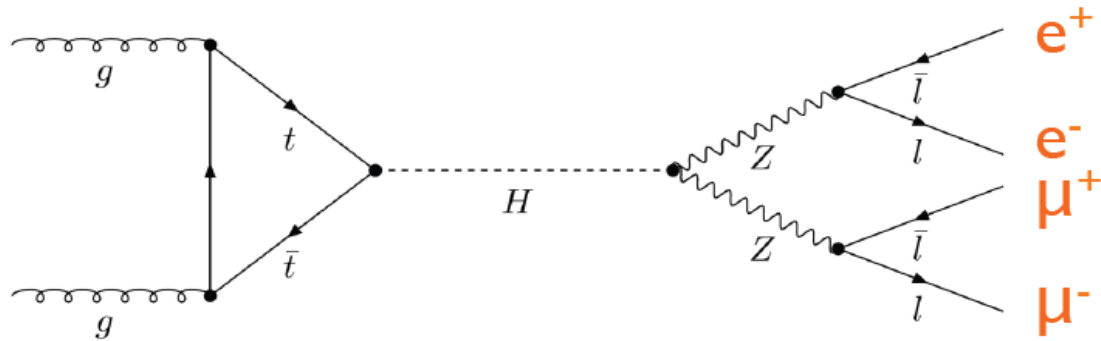

## Irreducible background

The final state is exactly the same, but it does not come from the particle you are looking for

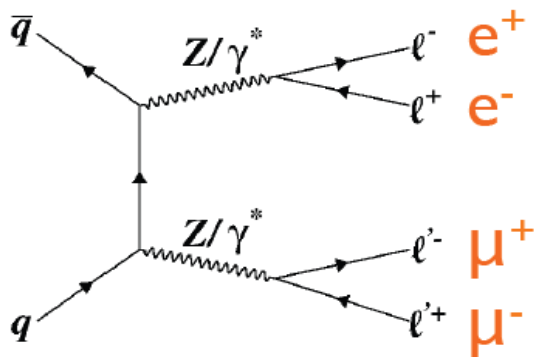

## Reducible background

The final state looks like the same, but some of the particles fake what you are looking for

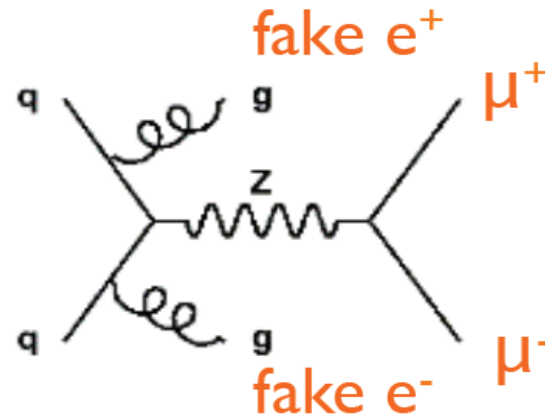



4e candidate.  $m_{4\ell} = 124.6$  GeV,  $m_{12} = 70.6$  GeV,  $m_{34} = 44.7$  GeV.

$e_1$ :  $P_T = 24.9$  GeV,  $\eta = -0.33$ ,  $\phi = 1.98$

$e_2$ :  $P_T = 53.9$  GeV,  $\eta = -0.40$ ,  $\phi = 1.69$

$e_3$ :  $P_T = 61.9$  GeV,  $\eta = -0.12$ ,  $\phi = 1.45$

$e_4$ :  $P_T = 17.8$  GeV,  $\eta = -0.51$ ,  $\phi = 2.84$

**ATLAS**  
EXPERIMENT  
<http://atlas.ch>

Run: 203602  
Event: 82614360  
Date: 2012-05-18  
Time: 20:28:11 CEST

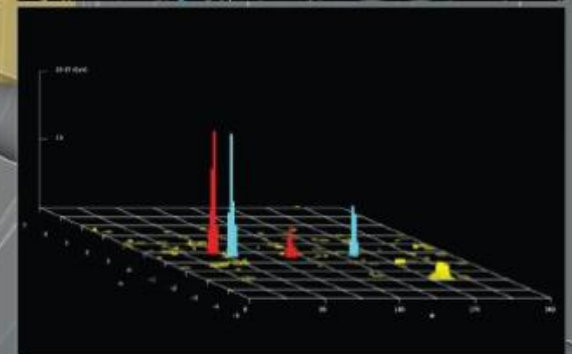
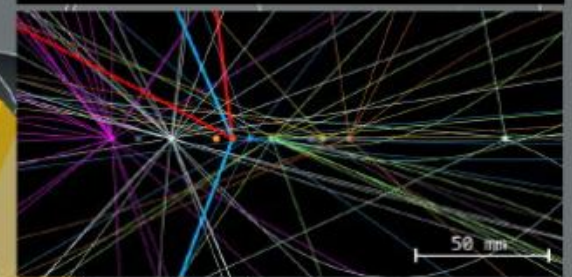
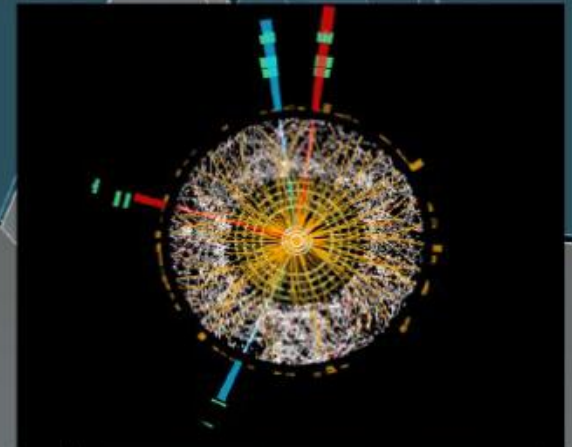
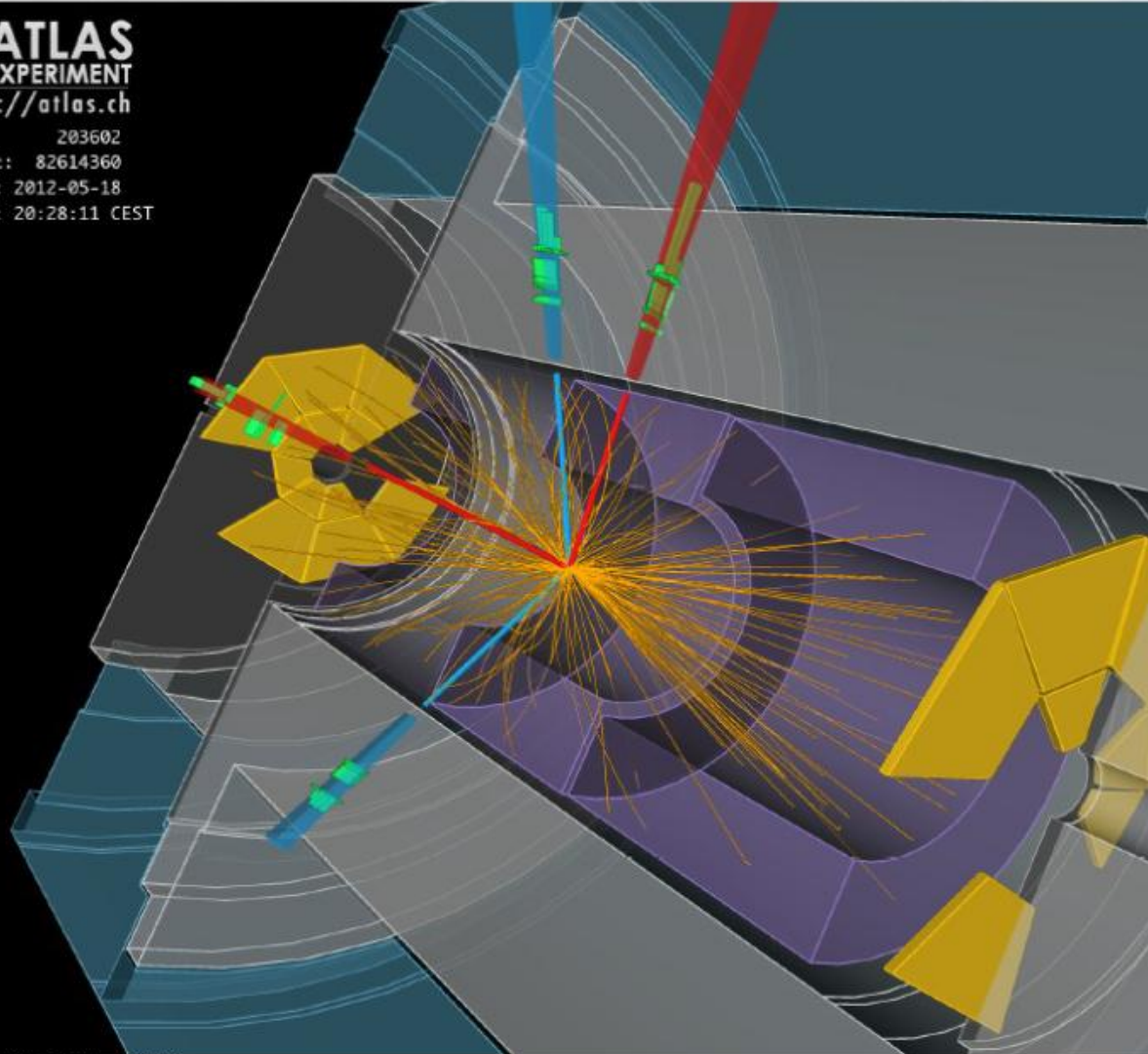

# Higgs like signal with 7 TeV and 8 TeV data

$H \rightarrow \gamma\gamma$

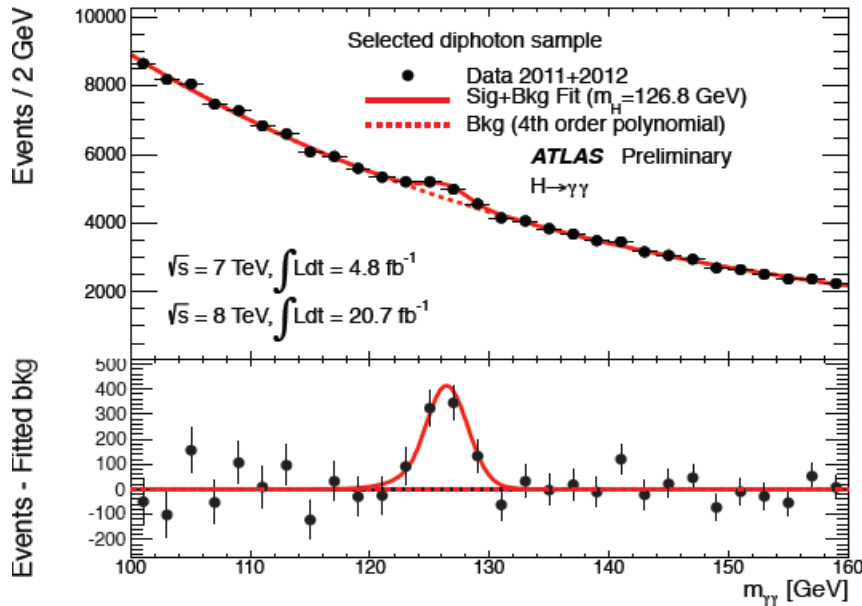

- Signal significance =  $7.4 \sigma$
- $m_H = 126.8 \pm 0.2$  (stat)  $\pm 0.7$  (syst) GeV
- $\mu = 1.65 \pm 0.34$  (deviation w.r.t. SM at  $2.3\sigma$ )

$H \rightarrow 4l$

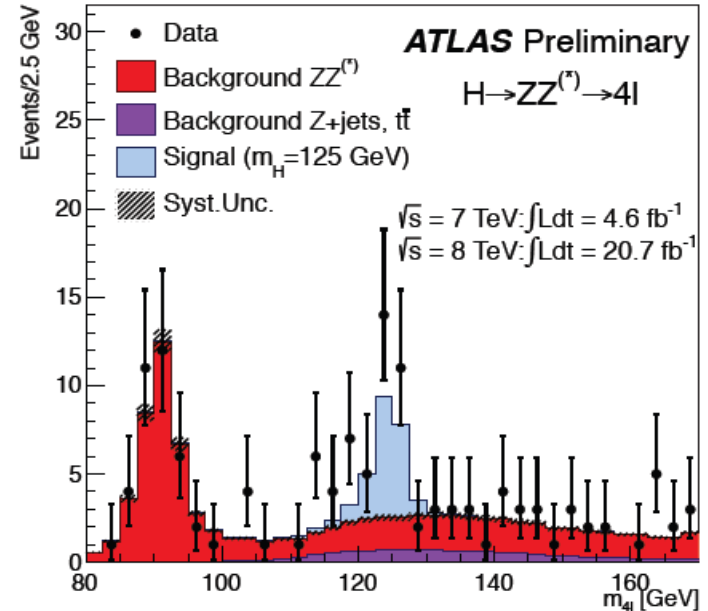

- Signal significance =  $6.6 \sigma$
- $m_H = 124.3^{+0.6}_{-0.5}$  (stat)  $^{+0.6}_{-0.3}$  (syst) GeV
- $\mu = 1.7 \pm 0.34$

# Mass measurement

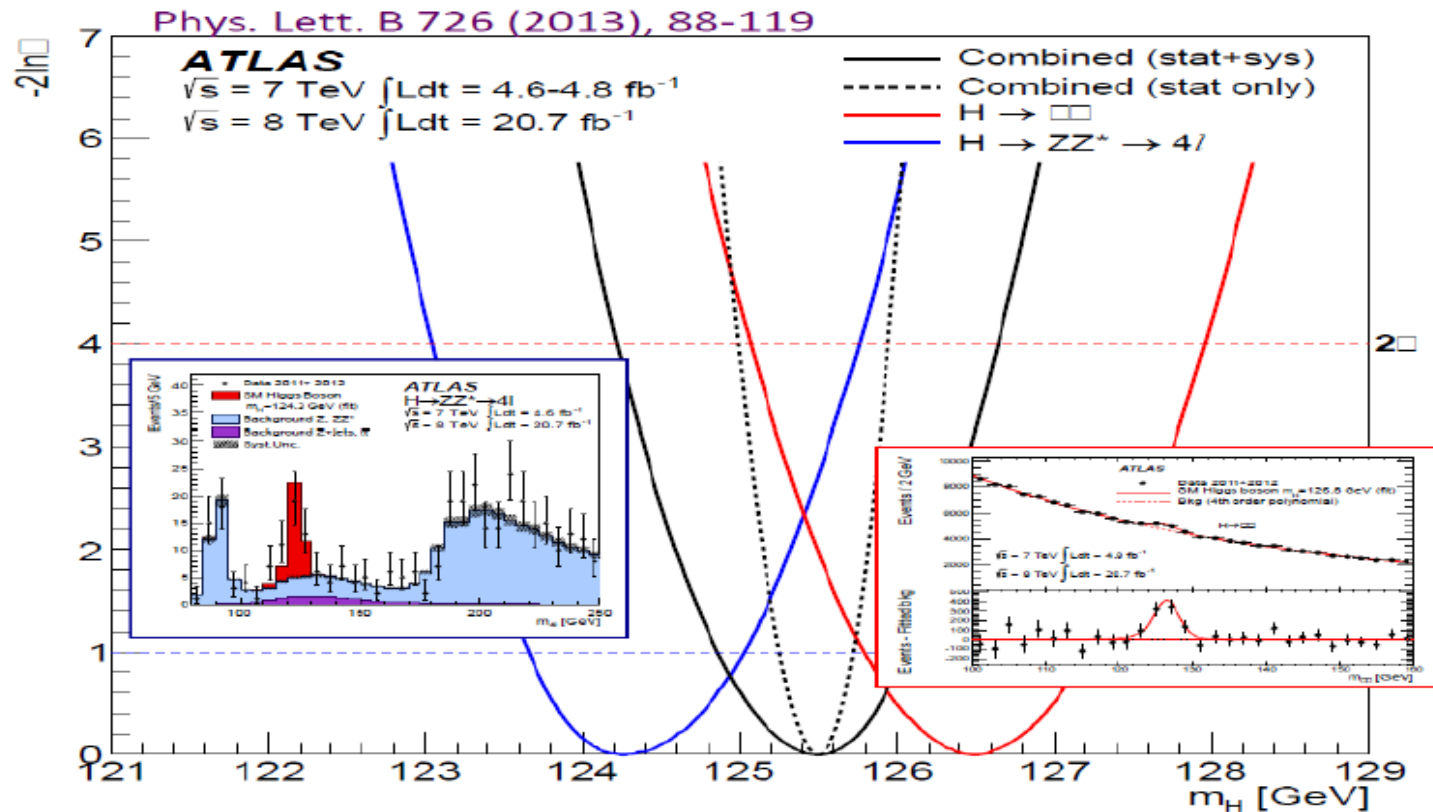

$$4\ell: M_H = 124.3 \pm 0.6_{\text{stat}} \pm 0.4_{\text{sys}} \text{ GeV}$$

$$\gamma\gamma: M_H = 126.8 \pm 0.2_{\text{stat}} \pm 0.7_{\text{sys}} \text{ GeV}$$

$$\text{Combined: } M_H = 125.5 \pm 0.2_{\text{stat}} \pm 0.6_{\text{sys}} \text{ GeV}$$

# And since then ....

## Panorama of ATLAS Higgs (125) Analyses

channel	ggF	VBF	VH	ttH	Yield	S/B (%)	Res. (GeV/c <sup>2</sup> )
$\gamma\gamma$	✓	✓	✓	✓	~ 450	1 - 20%	~ 1.6
$ZZ \rightarrow 4l$	✓				~ 16	1	~ 2.2
$WW \rightarrow l\nu l\nu$	✓	✓	✓		~ 250	10%	Poor
$\tau\tau$	✓	✓	✓		~ 330	0.3 – 30%	~ 20
VH(bb)			✓		~ 50	1 - 10%	~ 15
ttH(bb)				✓	~20	Up to ~5%	Poor (combinatorial)
$\mu\mu$	Inclusive				~ 40	~ 0.2 %	~ 2.5
Invisible	(✓)		✓		~ 30	~ 0.2	Poor
$Z\gamma$	Inclusive				~ 15	~ 0.5%	~ 1.8

# Which Higgs boson we have discovered?

Higgs boson was discovered in  $ZZ^*$ ,  $\gamma\gamma$  and  $WW^*$  decays

- Higgs boson mass is  $\sim 125.6$  GeV

Measured in  $H \rightarrow ZZ^* \rightarrow 4l$  and  $H \rightarrow \gamma\gamma$

ATLAS:  $m_H = 125.5 \pm 0.2$  (stat)  $\pm 0.6$  (syst) GeV

CMS:  $m_H = 125.7 \pm 0.3$  (stat)  $\pm 0.3$  (syst) GeV

- ATLAS and CMS data strongly favour  $J^P = 0^+$  SM quantum numbers; alternative models excluded at 95% CL.
- Signal strength  $\mu = \sigma/\sigma_{SM}$  consistent with 1

## Summer 2013:

All measured properties are compatible with SM hypothesis.



# Nobel price for predicting Higgs particle

2013 NOBEL PRIZE IN PHYSICS

**François Englert**  
**Peter W. Higgs**



© The Nobel Foundation. Photo: Lovisa Engblom.

THE BEH-MECHANISM, INTERACTIONS WITH SHORT RANGE FORCES  
AND SCALAR PARTICLES



8 October 2013

The Royal Swedish Academy of Sciences has decided to award the Nobel Prize in Physics for 2013 to

François Englert and Peter Higgs

*“for the theoretical discovery of a mechanism that contributes to our understanding of the origin of mass of subatomic particles, and which recently was confirmed through the discovery of the predicted fundamental particle, by the ATLAS and CMS experiments at CERN’s Large Hadron Collider”*

# Entrance of the Higgs into PDG

2013

Inaugural entrance of the Higgs boson in the PDG particle listing !

**Higgs Bosons —  $H^0$  and  $H^\pm$**

A REVIEW GOES HERE – Check our WWW List of Reviews

NODE=S055  
NODE=S055

CONTENTS: NODE=S055CNT  
NODE=S055CNT

$H^0$  (Higgs Boson)

- $H^0$  Mass
- $H^0$  Spin
- $H^0$  Decay Width
- $H^0$  Decay Modes
- $H^0$  Signal Strengths in Different Channels
  - Combined Final States
  - $W^+W^-$  Final State
  - $ZZ^*$  Final State
  - $\gamma\gamma$  Final State
  - $b\bar{b}$  Final State
  - $\tau^+\tau^-$  Final State

Standard Model  $H^0$  (Higgs Boson) Mass Limits

- $H^0$  Direct Search Limits
- $H^0$  Indirect Mass Limits from Electroweak Analysis

Searches for Other Higgs Bosons

- Mass Limits for Neutral Higgs Bosons in Supersymmetric Models
  - $H^0$  (Higgs Boson) Mass Limits in Supersymmetric Models
  - $A^0$  (Pseudoscalar Higgs Boson) Mass Limits in Supersymmetric Models
- $H^0$  (Higgs Boson) Mass Limits in Extended Higgs Models
  - Limits in General two-Higgs-doublet Models
  - Limits for  $H^0$  with Vanishing Yukawa Couplings
  - Limits for  $H^0$  Decaying to Invisible Final States
  - Limits for Light  $A^0$
  - Other Limits
- $H^\pm$  (Charged Higgs) Mass Limits
- Mass Limits for  $H^{\pm\pm}$  (doubly-charged Higgs boson)
  - Limits for  $H^{\pm\pm}$  with  $T_3 = \pm 1$
  - Limits for  $H^{\pm\pm}$  with  $T_3 = 0$

---

**$H^0$  (Higgs Boson)**

The observed signal is called a Higgs Boson in the following, although its detailed properties and in particular the role that the new particle plays in the context of electroweak symmetry breaking need to be further clarified. The signal was discovered in searches for a Standard Model (SM)-like Higgs. See the following section for mass limits obtained from those searches.

NODE=S055CNT

NODE=S055210  
NODE=S055210

<b><math>H^0</math> MASS</b>	DOCUMENT ID	TECN	COMMENT
<b>126.0 ± 0.4 OUR AVERAGE</b>			
125.0 ± 0.4 ± 0.4	1 CHATRCHYAN13J	CMS	$pp$ , 7 and 8 TeV
126.0 ± 0.4 ± 0.4	2 AAD	12N ATLAS	$pp$ , 7 and 8 TeV
●●● We do not use the following data for averages, fits, limits, etc. ●●●			
126.2 ± 0.0 ± 0.2	3 CHATRCHYAN13J	CMS	$pp$ , 7 and 8 TeV
125.3 ± 0.4 ± 0.5	4 CHATRCHYAN12N	CMS	$pp$ , 7 and 8 TeV

OCCUR=2

NODE=S055HBM;LINKAGE=CA  
NODE=S055HBM;LINKAGE=AA

NODE=S055HBM;LINKAGE=CT

NODE=S055HBM;LINKAGE=CH

<sup>1</sup> Combined value from  $ZZ$  and  $\gamma\gamma$  final states.  
<sup>2</sup> AAD 12N obtain results based on  $4.6\text{--}4.8\text{ fb}^{-1}$  of  $pp$  collisions at  $E_{\text{CM}} = 7\text{ TeV}$  and  $5.9\text{--}5.9\text{ fb}^{-1}$  at  $E_{\text{CM}} = 8\text{ TeV}$ . An excess of events over background with a local significance of  $3.9\sigma$  is observed at  $m_{H^0} = 126\text{ GeV}$ . See also AAD 120A.  
<sup>3</sup> Result based on  $ZZ \rightarrow 4\ell$  final states in  $5.1\text{ fb}^{-1}$  of  $pp$  collisions at  $E_{\text{CM}} = 7\text{ TeV}$  and  $12.2\text{ fb}^{-1}$  at  $E_{\text{CM}} = 8\text{ TeV}$ .  
<sup>4</sup> CHATRCHYAN 12N obtain results based on  $4.9\text{--}5.1\text{ fb}^{-1}$  of  $pp$  collisions at  $E_{\text{CM}} = 7\text{ TeV}$  and  $5.1\text{--}5.1\text{ fb}^{-1}$  at  $E_{\text{CM}} = 8\text{ TeV}$ . An excess of events over background with a local significance of  $5.0\sigma$  is observed at about  $m_{H^0} = 125\text{ GeV}$ . See also CHATRCHYAN 120Y.

# H<sup>0</sup>



# Spin observables for $H \rightarrow \gamma\gamma$

Separate  $0^+$  and  $2^+$  spin hypotheses using the angular correlation of the two photons

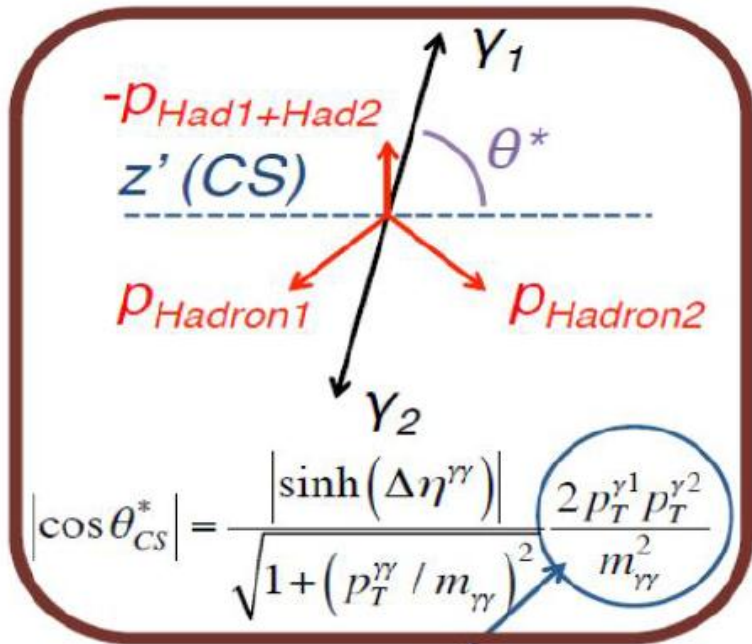

Collins-Soper frame used to get reference axis  $z'$  for  $\cos(\theta^*)$

- $z$ -axis bisects angle between the momenta of colliding hadrons
- Minimizes impact of ISR
- Better  $0^+$  /  $2^+$  discrimination

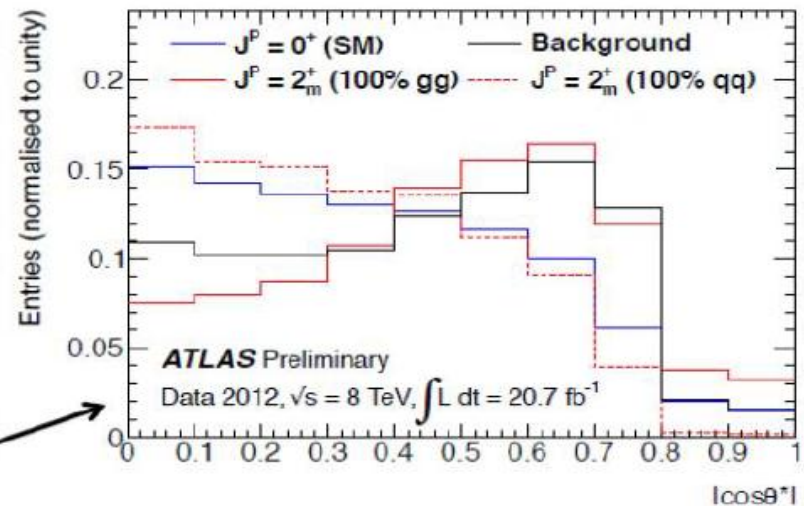

Relative  $p_T$  cuts on the photons remove most correlation with  $m_{\gamma\gamma}$

$qq \rightarrow 2^+$  very similar to SM  $gg \rightarrow 0^+$

# Spin study with H->4l

- SM predicts  $J^{PC} = 0^{++}$
- Angular distributions sensitive to JP
- Wide range of alternative quantum numbers excluded at >99% CL
- All observations consistent with expectations for the SM Higgs boson

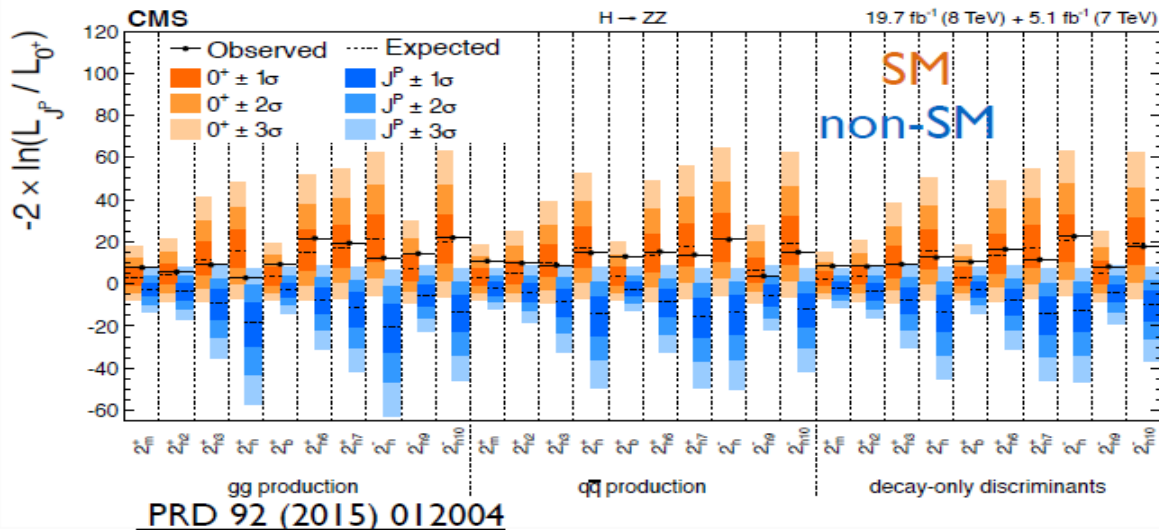
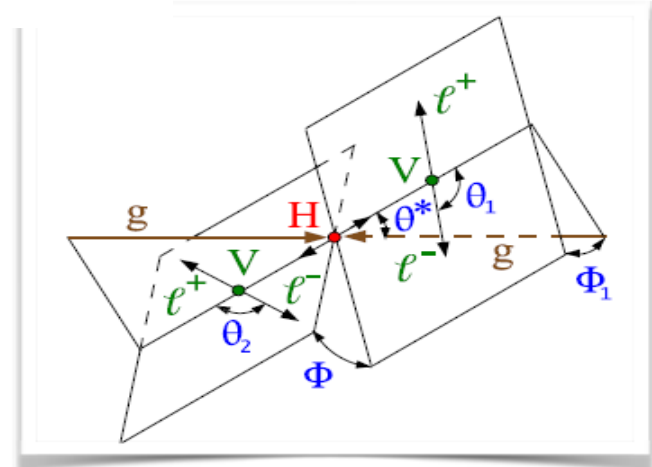

Tests of  
alternative  $J^P$   
hypotheses in ZZ

# Higgs boson decay width

$$m_h = 125 \text{ GeV} \rightarrow \Gamma_h = 4.07 \text{ MeV}$$

$$\tau_h = 1.62 \cdot 10^{-22} \text{ [s]}$$

A deviation would imply a decay to non-SM particles

Differential Higgs production cross-section

$$\frac{d\sigma_{gg \rightarrow H \rightarrow ZZ}}{dm_{ZZ}^2} \sim \frac{g_{ggH}^2 g_{HZZ}^2}{(m_{ZZ}^2 - m_H^2)^2 + m_H^2 \Gamma_H^2}$$

$\Gamma_h$  cannot be accessed directly (experimental resolution  $\sim 1\text{-}2 \text{ GeV}$ )

# Indirect measurement

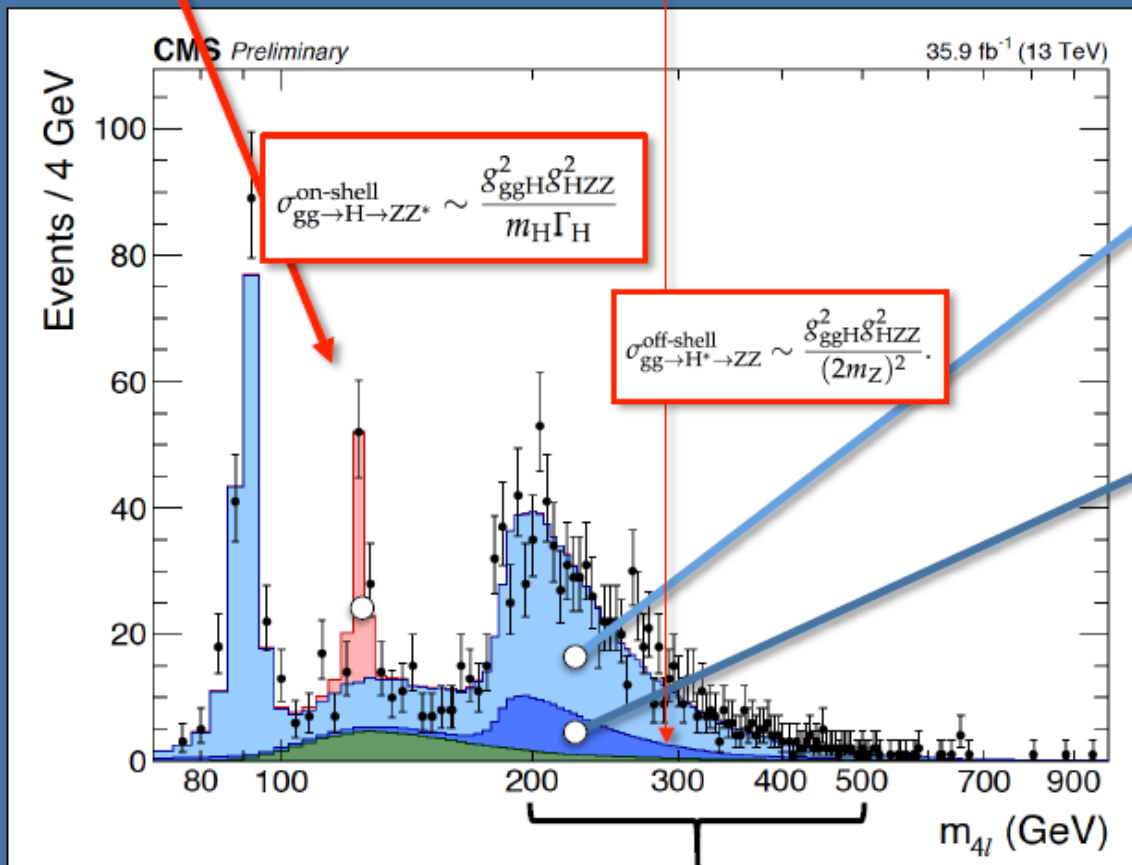
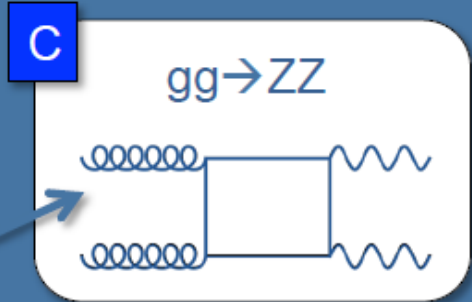
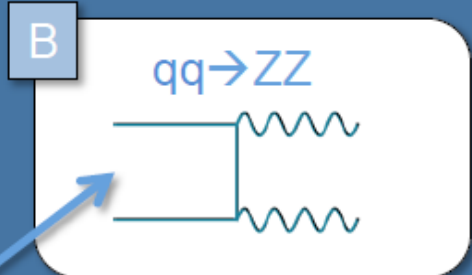
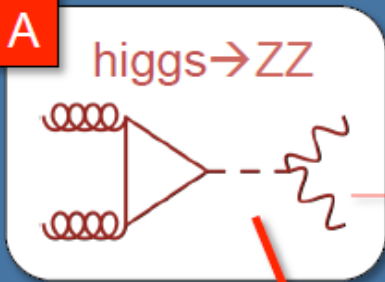

Interference between **A** and **C** :  $(A+C)^2 = A^2 + C^2 + 2AC$

*tiny*  $\leftarrow$   $\rightarrow$  *accessible*

# Higgs boson decay width

## Total width

- Lower bound on total width from decay measurements
- Direct experimental measurements probe 3 orders of magnitude larger than SM width ( $\Gamma=4$  MeV)
- Indirect constraint\* on the width via measurement of ratio of off-peak to on-peak cross-section
  - CMS:  $\Gamma < 13$  MeV
  - ATLAS:  $\Gamma < 22$  MeV

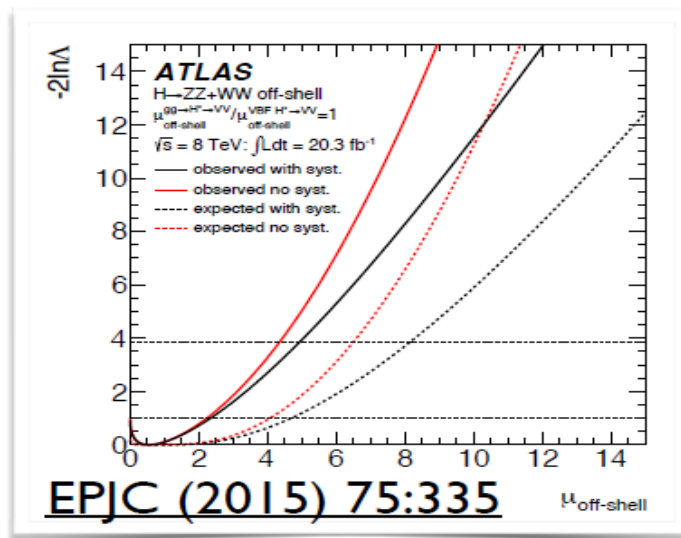
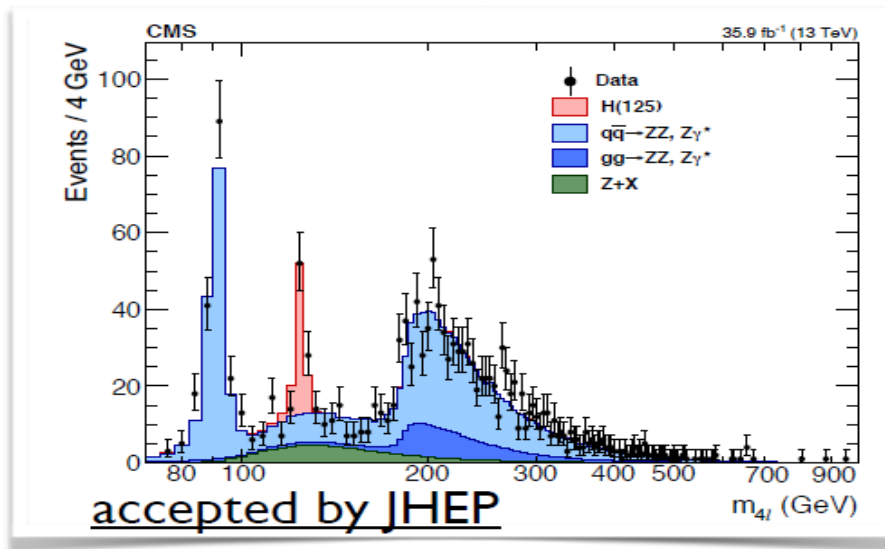

\*N. Kauer and G. Passarino, JHEP (2012) 2012: 116  
 \*F. Caola and K. Melnikov, PRD88 (2013) 054024

# Couplings: kappa-framework

Scale factor for each (fundamental) coupling:

$$\sigma(i \rightarrow h \rightarrow f) = \kappa_i^2 \sigma_i^{SM} \frac{\kappa_f^2 \Gamma_f^{SM}}{\kappa_h^2 \Gamma_h^{SM}}$$

$$\begin{aligned} \mathcal{L} = & \kappa_3 \frac{m_H^2}{2v} H^3 + \kappa_Z \frac{m_Z^2}{v} Z_\mu Z^\mu H + \kappa_W \frac{2m_W^2}{v} W_\mu^+ W^{-\mu} H \\ & + \kappa_g \frac{\alpha_s}{12\pi v} G_{\mu\nu}^a G^{a\mu\nu} H + \kappa_\gamma \frac{\alpha}{2\pi v} A_{\mu\nu} A^{\mu\nu} H + \kappa_{Z\gamma} \frac{\alpha}{\pi v} A_{\mu\nu} Z^{\mu\nu} H \\ & - \left( \kappa_t \sum_{f=u,c,t} \frac{m_f}{v} f\bar{f} + \kappa_b \sum_{f=d,s,b} \frac{m_f}{v} f\bar{f} + \kappa_\tau \sum_{f=e,\mu,\tau} \frac{m_f}{v} f\bar{f} \right) H \end{aligned}$$

Scale Higgs boson couplings (wrt SM): production & decay



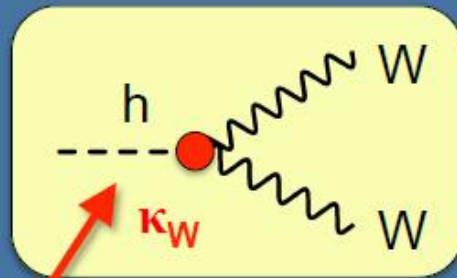
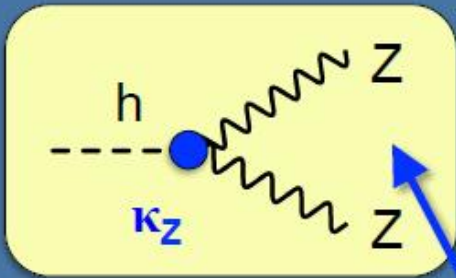

$$\begin{aligned}
 \mathcal{L} = & \kappa_3 \frac{m_H^2}{2v} H^3 + \kappa_Z \frac{m_Z^2}{v} Z_\mu Z^\mu H + \kappa_W \frac{2m_W^2}{v} W_\mu^+ W^{-\mu} H \\
 & + \kappa_g \frac{\alpha_s}{12\pi v} G_{\mu\nu}^a G^{a\mu\nu} H + \kappa_\gamma \frac{\alpha}{2\pi v} A_{\mu\nu} A^{\mu\nu} H + \kappa_{Z\gamma} \frac{\alpha}{\pi v} A_{\mu\nu} Z^{\mu\nu} H \\
 & + \left( \kappa_t \sum_{f=u,c,t} \frac{m_f}{v} f\bar{f} + \kappa_b \sum_{f=d,s,b} \frac{m_f}{v} f\bar{f} + \kappa_\tau \sum_{f=e,\mu,\tau} \frac{m_f}{v} f\bar{f} \right) H
 \end{aligned}$$

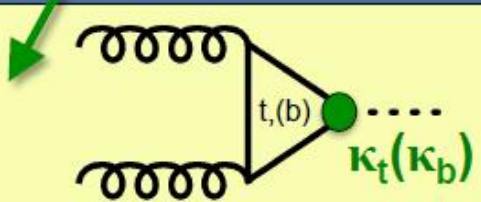

$$\kappa_g^2 \propto 1.06\kappa_t^2 - 0.07\kappa_t\kappa_b + 0.01\kappa_b^2$$

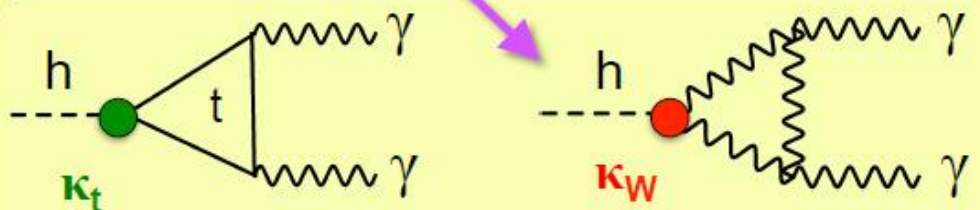

$$\kappa_\gamma^2 \propto 1.59\kappa_W^2 - 0.66\kappa_W\kappa_t + 0.07\kappa_t^2$$



# What do we measure?

We measure event yields

We want to derive couplings and signal strengths

The first thing we want to measure is the the "signal strength" per channel

The analysis is using discriminators (usually reconstructed mass related) to increase S/B

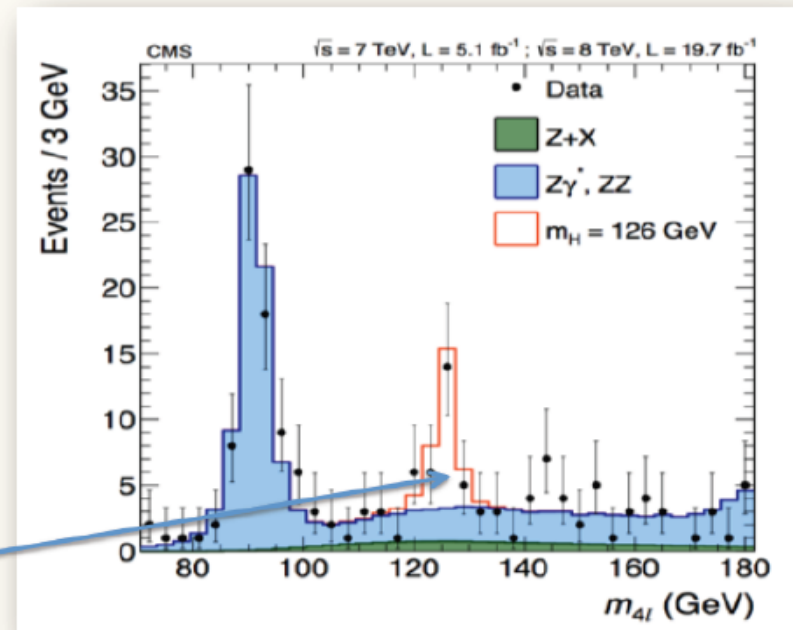

$$n_s^i = \mu^i \times \sum_p (\sigma^p \times Br^i)_{SM} \times A_p^i \times \epsilon_p^i \times Lumi$$

$p \in (ggF, VBF, VH, ttH) \quad i \in (\gamma\gamma, ZZ, WW, bb, \tau\tau)$

$$\mu^{ZZ}(@125.5 \text{ GeV}) = 1.44^{+0.40}_{-0.35}$$

6.6 $\sigma$  (4.4 exp) ATLAS

$$\mu^{ZZ}(@125.6 \text{ GeV}) = 0.93^{+0.26+0.13}_{-0.23-0.09}$$

6.8 $\sigma$  (6.7 exp) CMS

# Higgs boson decay channels

## Significance

7.4 $\sigma$  (4.3 $\sigma$ )

6.6 $\sigma$  (4.4 $\sigma$ )

3.8 $\sigma$  (3.8 $\sigma$ )

4.1 $\sigma$  (3.2 $\sigma$ )

0.36 $\sigma$  (1.64 $\sigma$ )

Obs. (Exp.)

3.2 $\sigma$  (4.2 $\sigma$ )

6.8 $\sigma$  (6.7 $\sigma$ )

4.3 $\sigma$  (5.8 $\sigma$ )

3.3 $\sigma$  (3.7 $\sigma$ )

2.1 $\sigma$  (2.1 $\sigma$ )

Obs. (Exp.)

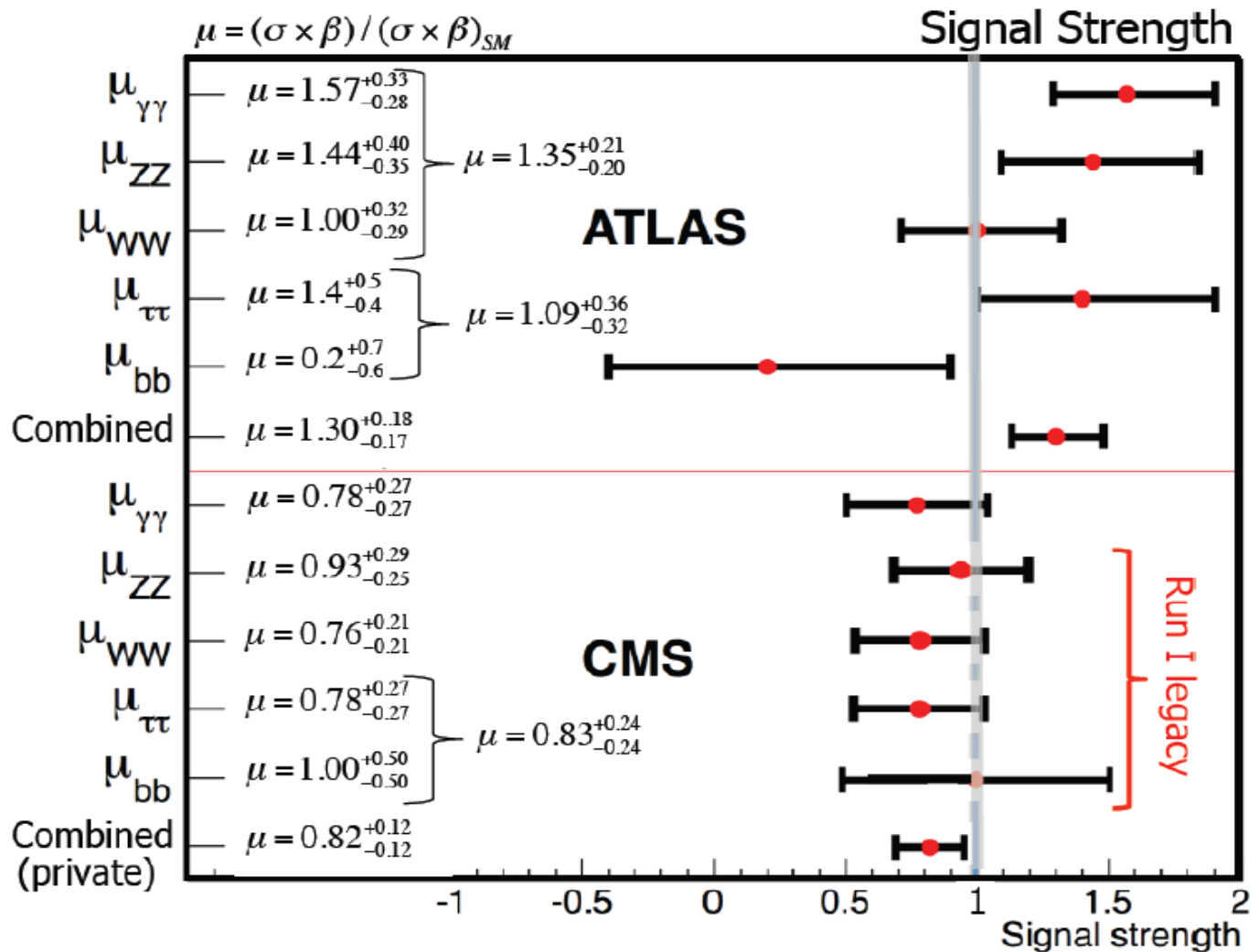

# Overall comparison of all couplings results

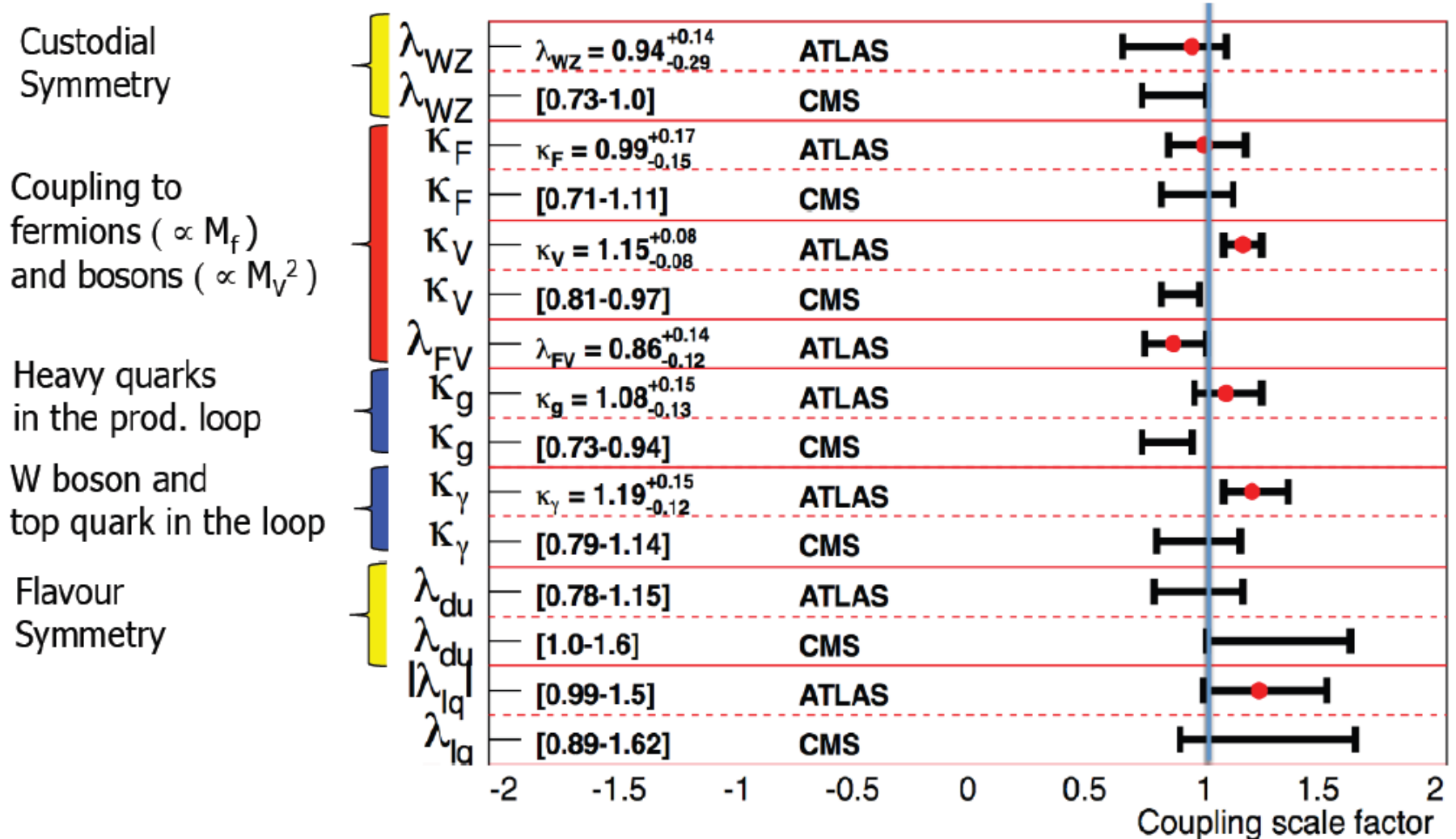

# Combination of two experiments

(ATLAS-CONF-2015-044, CMS-PAS-HIG-15-002)

By fitted production mode arXiv:1507.04548 [hep-ex]

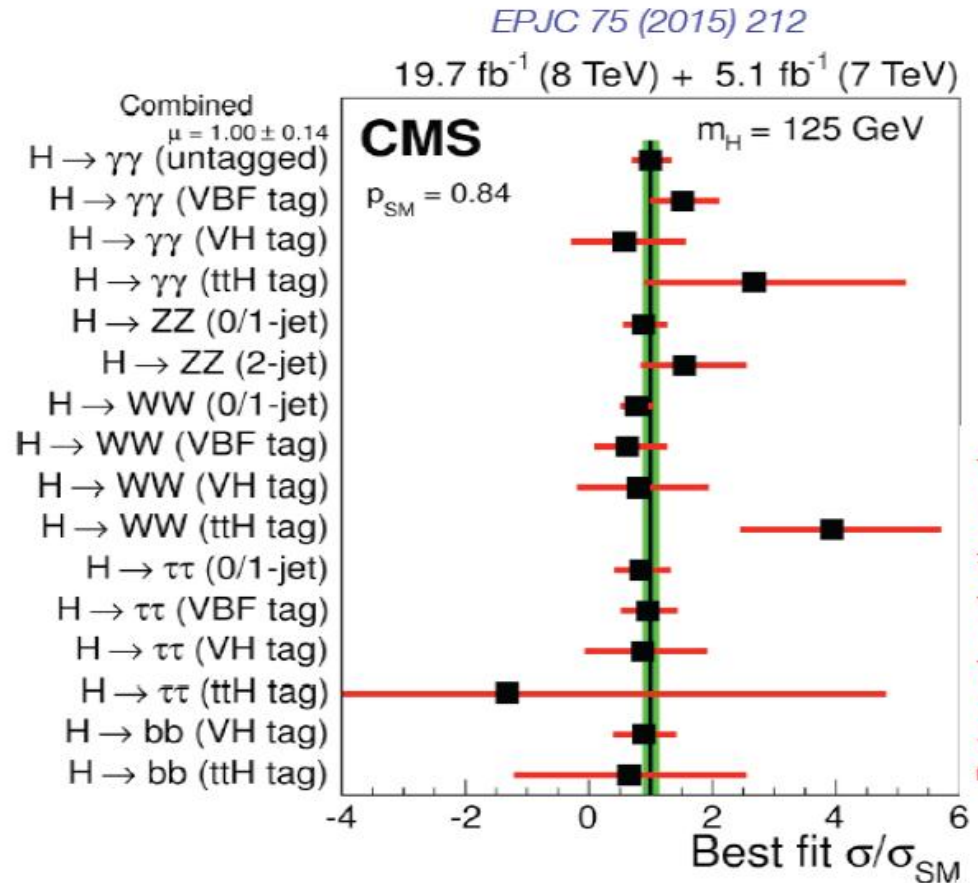
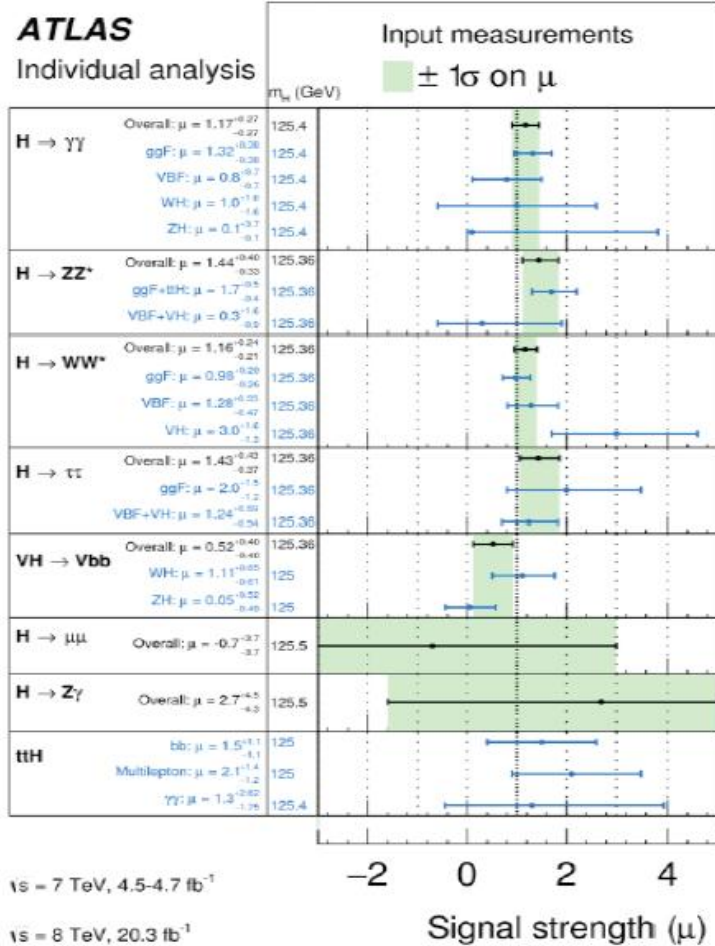

# The global signal strength

- Assuming SM ratios of production cross-sections and decay rates

$$\mu = 1.09^{+0.11}_{-0.10}$$

*Most precise result at the expense of the largest assumptions*

$$= 1.09^{+0.07}_{-0.07} \text{ (stat)} \quad ^{+0.04}_{-0.04} \text{ (expt)} \quad ^{+0.03}_{-0.03} \text{ (thbgd)} \quad ^{+0.07}_{-0.06} \text{ (thsig)}$$

*Stat and Th.Sig of comparable size  
(Th.Sig dominated by ggF cross-section uncertainty)*

# Signal strength by production and decay mode

**Production signal strengths**  
(SM values of BRs assumed)

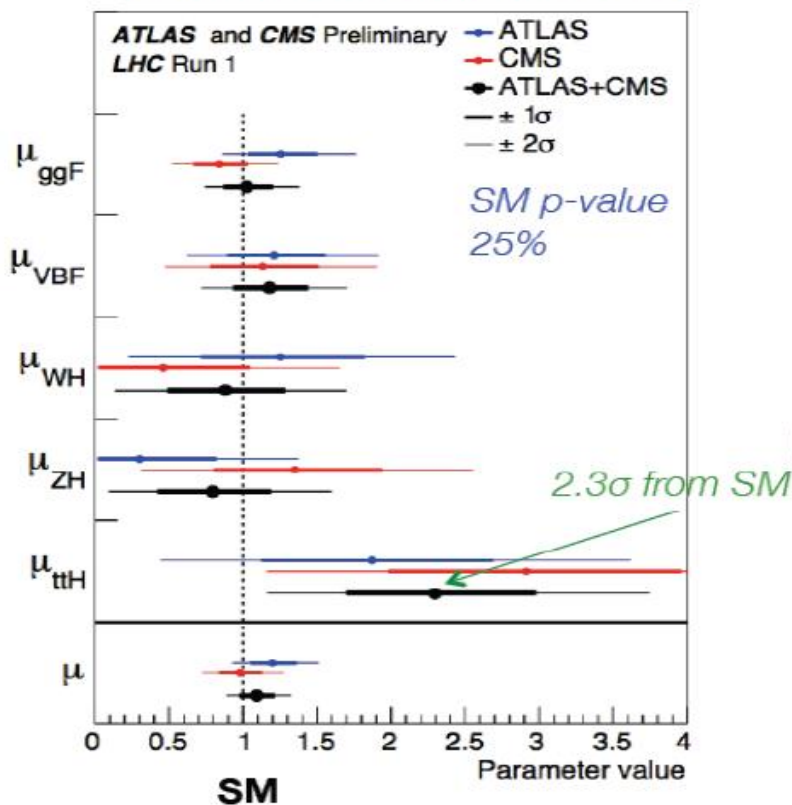

**Decay signal strengths**  
(SM value of production  $\sigma$ 's assumed)

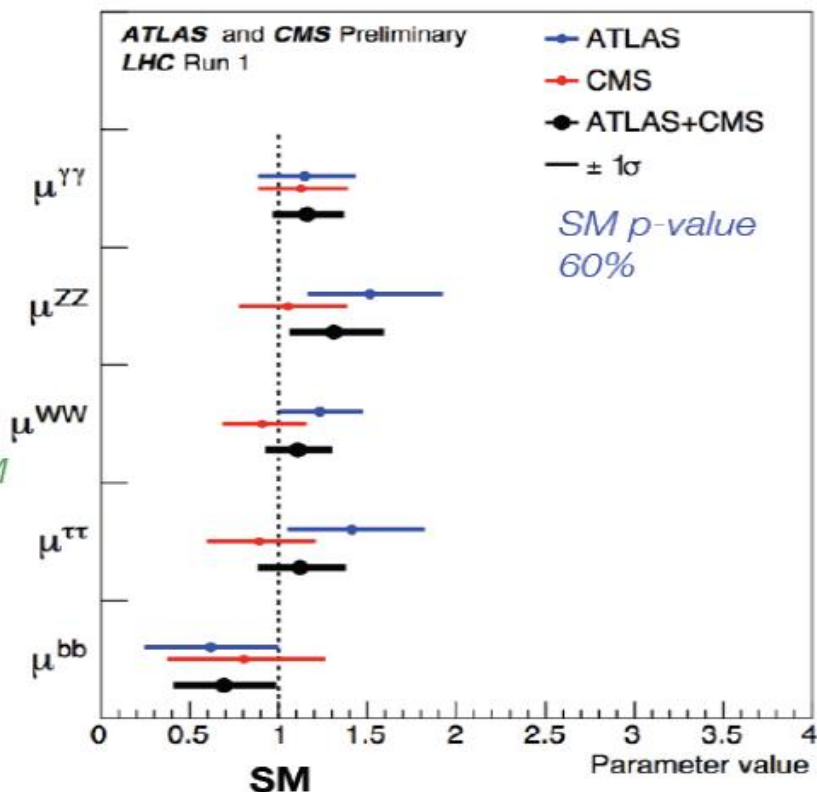



# Constraints on three-level Higgs couplings

- Assume only SM physics in loops, no invisible or unseen BSM Higgs decays
- Fit for scaling parameters for Higgs couplings to W, Z, b, t,  $\tau$ ,  $\mu$

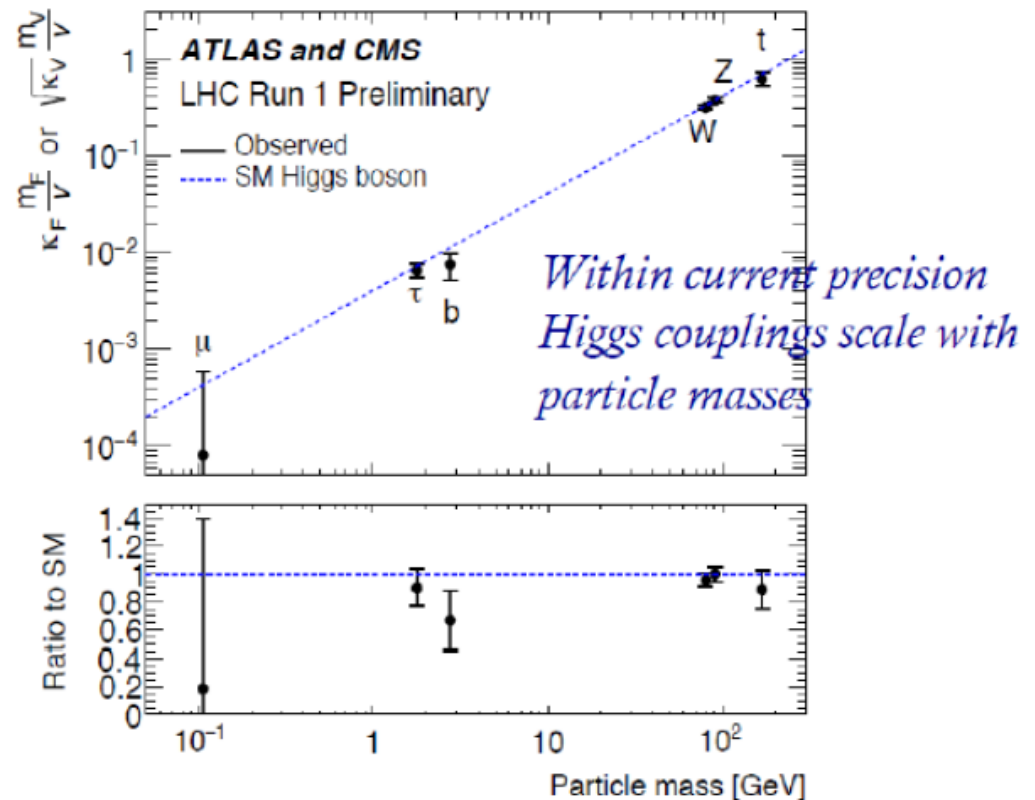
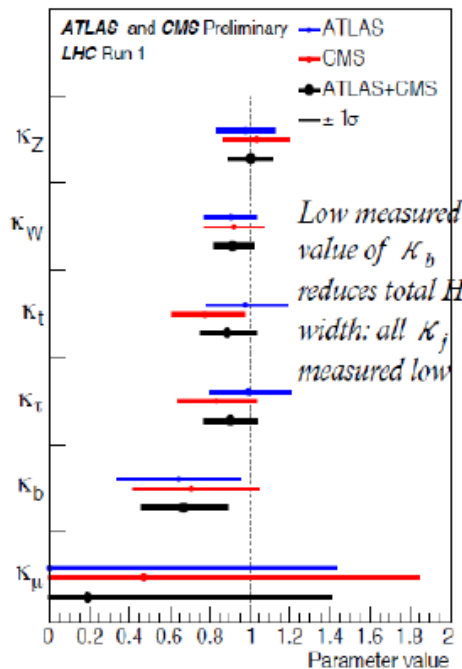

# Concluding Higgs couplings measurements

ATLAS and CMS Higgs boson coupling results have been combined, **sensitivity on signal strength improved by almost  $\sqrt{2}$**

- **Higgs to  $\tau\tau$  and VBF production established at more than  $5\sigma$  level**
- The most precise results on Higgs production and decay and constraints on its couplings have been obtained at  $O(10\%)$  precision.
- Different parametrisations have been studied, all consistent with the SM predictions within uncertainties
- **SM p-value of all combined fits in range of 10%-88%**

# What did we know from Run 1

- Discovery of a new neutral scalar boson, first in diboson, then in di-fermion decays

- Observations:

- $H \rightarrow \gamma\gamma$ ,  $H \rightarrow ZZ \rightarrow 4l$
- $H \rightarrow WW \rightarrow 2l2\nu$
- $H \rightarrow \tau\tau$
- gg-fusion and VBF production
- Evidence for VH and ttH processes

- Individual and combined ATLAS and CMS measurements include

- Mass and width
- Production rate (@10% accuracy)
- Decays
- Spin, parity  $J^{PC} = 0^{++}$

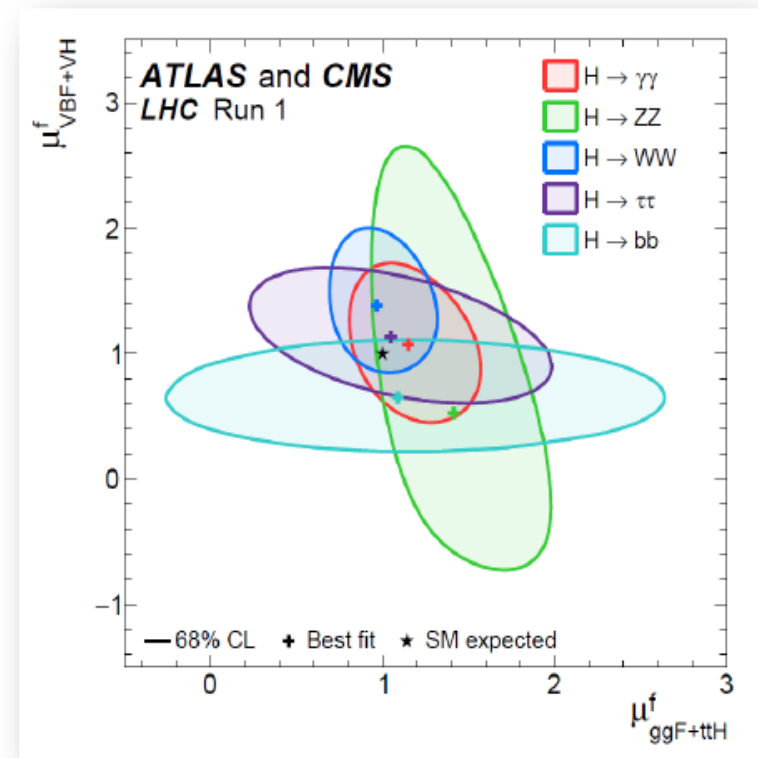

- Initial compatibility with the Standard Model Higgs

JHEP08 (2016) 045

PRL114 (2015)191803

EPJC75(2015) 212

PLB726 (2013) 120

# Lepton-Photon 2021 (January 2022)

## Higgs mass:

- Measurement done in  $H \rightarrow 4\ell$  and  $H \rightarrow \gamma\gamma$  only
- precision dominated by statistics and experimental systematics

$$H \rightarrow ZZ^* \rightarrow 4\ell$$

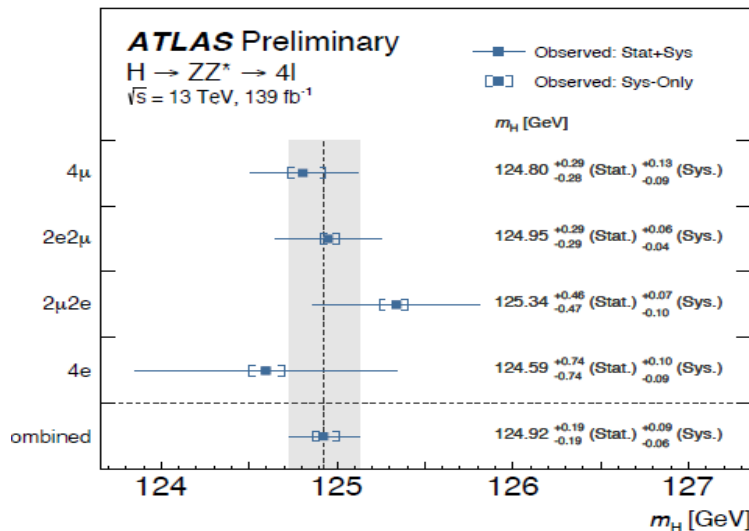

$$H \rightarrow \gamma\gamma, ZZ^* \rightarrow 4\ell$$

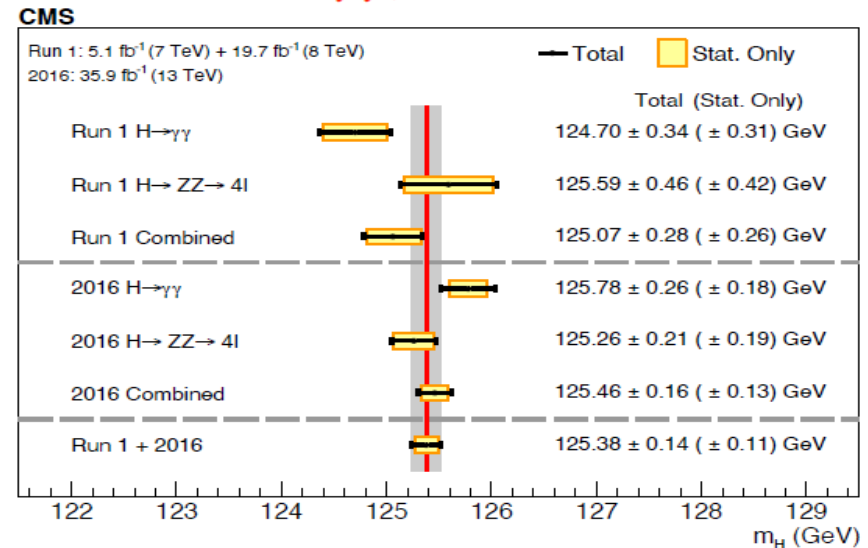

$$m_H = 124.92 \pm 0.19 \text{ (stat)} \text{ } ^{+0.09}_{-0.06} \text{ (syst)} \text{ GeV}$$

$$m_H = 125.38 \pm 0.14 \text{ (} \pm 0.11 \text{) GeV}$$

precision on  $m_H$ :  $140 \text{ MeV} \approx 0.1\%$

# Lepton-Photon 2021 (January 2022)

- Combination of  $H \rightarrow 4\ell$ ,  $H \rightarrow 2\ell 2\nu$  analysis of full Run2 data [CMS-PAS-HIG-21-013](#)
  - $H \rightarrow 4\ell$  analysis on full Run2, using on-shell + off-shell events
  - $H \rightarrow 2\ell 2\nu$  analysis on full Run2, with  $\ell = e, \mu$  final states and categorized in jet multiplicity

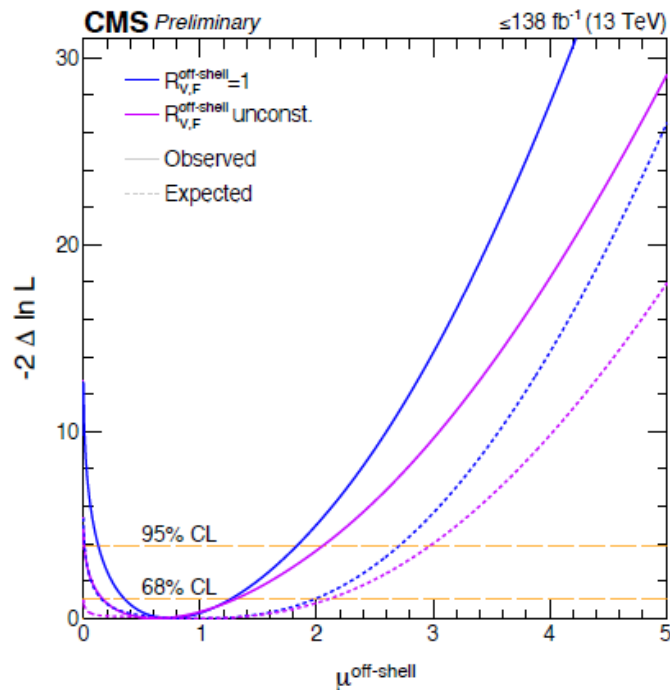

**first evidence** for off-shell  
Higgs production at  **$3.6\sigma$**

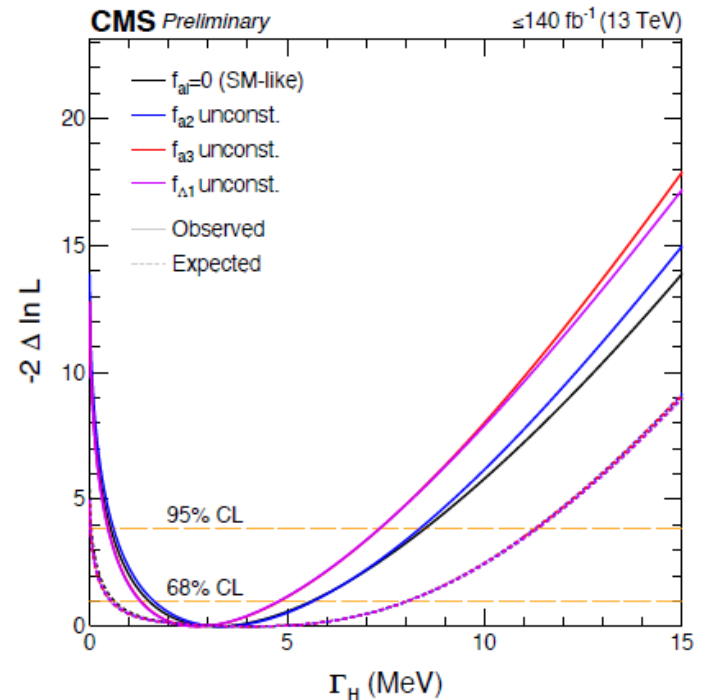

$$\Gamma_H = 3.2^{+2.4}_{-1.7} \text{ MeV}$$

$\sigma(\Gamma_H) \sim 50\%$ : most precise measurement up to now



# Lepton-Photon 2021 (January 2022)

## Higgs CP and anomalous couplings:

- After Run1 excluded spin-1 and spin-2 hypotheses, analyses with full Run2 investigate CP structure in a vast program of measurements
- HVV couplings tested with  $H \rightarrow 4\ell$  using production and decay
  - production categories: untagged, boosted, VBF 1/2 jets, VH H hadronic/leptonic

[Phys. Rev D 104 \(2021\) 052004](#)

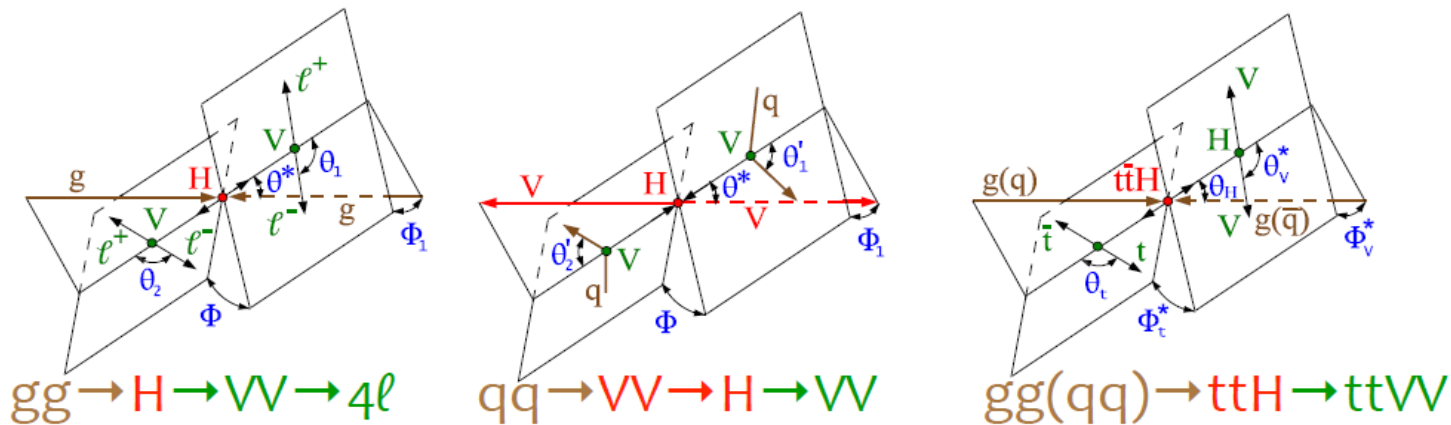

$$A(HV_1V_2) = \frac{1}{v} \left[ a_1^{VV} + \frac{\kappa_1^{VV} q_{V1}^2 + \kappa_2^{VV} q_{V2}^2}{(\Lambda_1^{VV})^2} + \frac{\kappa_3^{VV} (q_{V1} + q_{V2})^2}{(\Lambda_Q^{VV})^2} \right] m_{V1}^2 \epsilon_{V1}^* \epsilon_{V2}^* + \frac{1}{v} a_2^{VV} f_{\mu}^{*(1)} f^{*(2),\mu\nu} + \frac{1}{v} a_3^{VV} f_{\mu}^{*(1)} \tilde{f}^{*(2),\mu\nu}$$

$a_1$ : SM

$a_2$ : CP even anomalous coupling

$a_3$ : CP odd anomalous coupling

# Lepton-Photon 2021 (January 2022)

## VBF Higgs, H->invisible:

- Part of Higgs width could be due to decays to not detectable particles: searches can be interpreted within Dark Matter models
- CMS: Search of 2 forward jets with high  $M_{jj}$  and high  $|\Delta\eta_{jj}| + MET$ 
  - Dominant backgrounds:  $W \rightarrow \ell\nu$  and  $Z \rightarrow \nu\nu + jets$
  - **systematically dominated** by V+jets modelling
- ATLAS: VBF combined to VH production
  - $V = Z \rightarrow \ell\ell$ ;  $V = (W, Z) \rightarrow had$

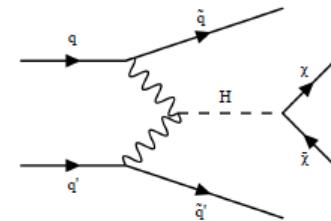

[ATLAS-CONF-2020-008](#)  
[HIGG-2018-26](#)  
[CMS-PAS-HIG-20-003](#)  
[ATLAS-CONF-2020-052](#)

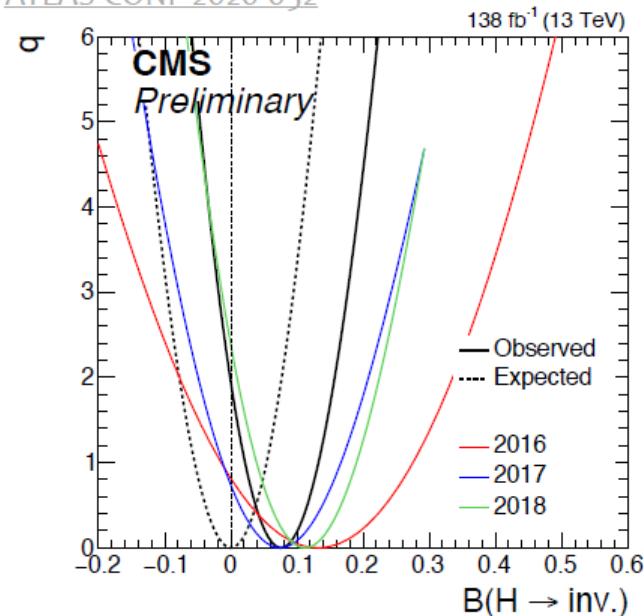
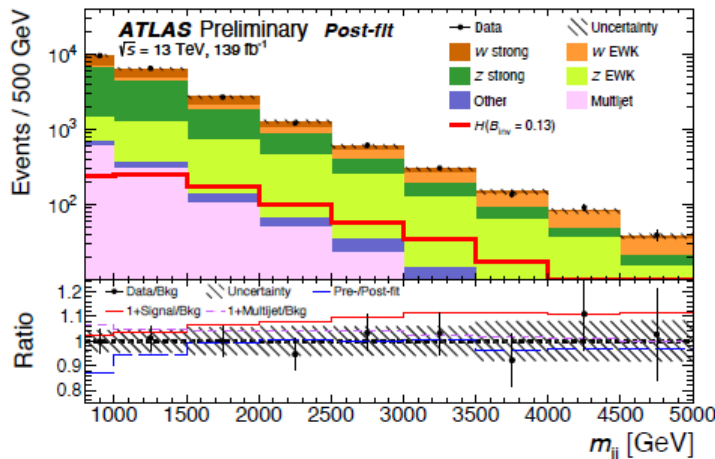

ATLAS:  $BR(H \rightarrow inv) < 0.11$  (exp 0.11)

CMS:  $BR(H \rightarrow inv) < 0.17$  (exp 0.11)

# Lepton-Photon 2021 (January 2022)

## STSX cross-section measurement:

- Approach devoted to minimize simultaneously experimental and theoretical uncertainties on Higgs cross section measurements
- Split Higgs production modes in gen-level bins in  $p_T$ ,  $N(\text{jets})$ ,  $m_{jj}$ 
  - Assume within each bin acceptance is only weakly depending on SM kinematics, used in STXS measurements as proxy for true properties
  - Allow re-interpretation of results in different models
  - Look for BSM in extreme bins of the phase space

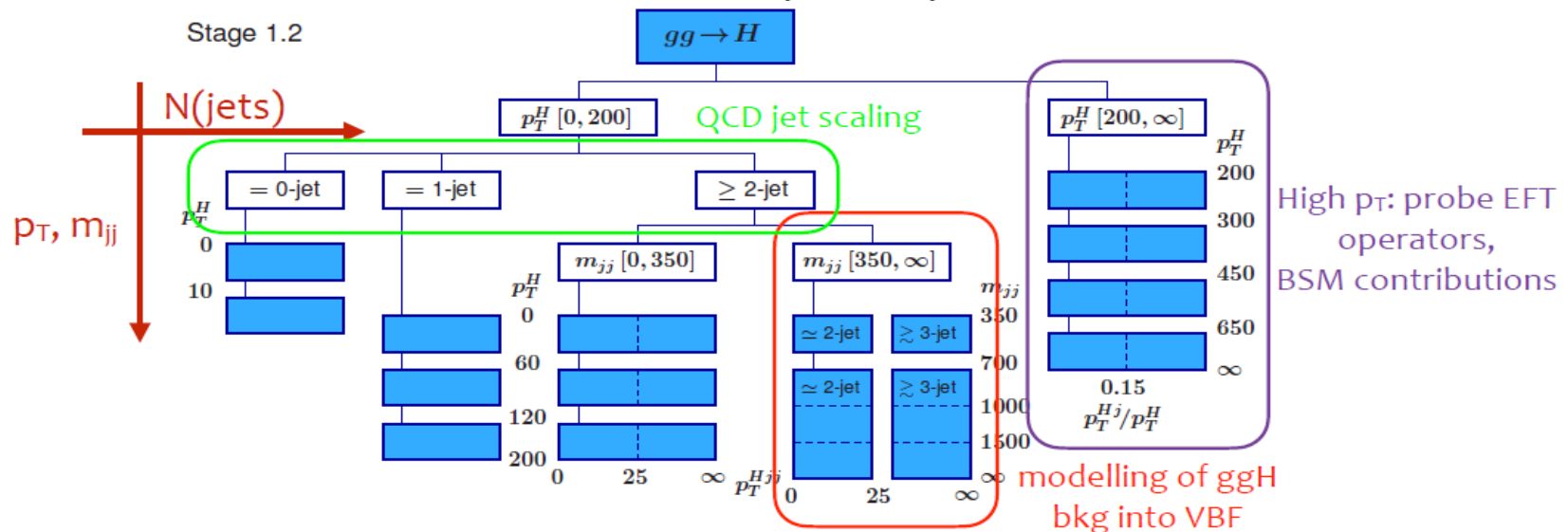

# Lepton-Photon 2021 (January 2022)

## STXS cross-section measurement:

- $H \rightarrow \gamma\gamma$  channel well suited for STXS measurement:
  - high yields, efficiency and S/B across whole phase space
  - robust background estimation from  $m(\gamma\gamma)$
- **reaching first ttH differential measurements**

JHEP 07 (2021) 027

ATLAS-CONF-2020-026

**ATLAS p-value = 60%**

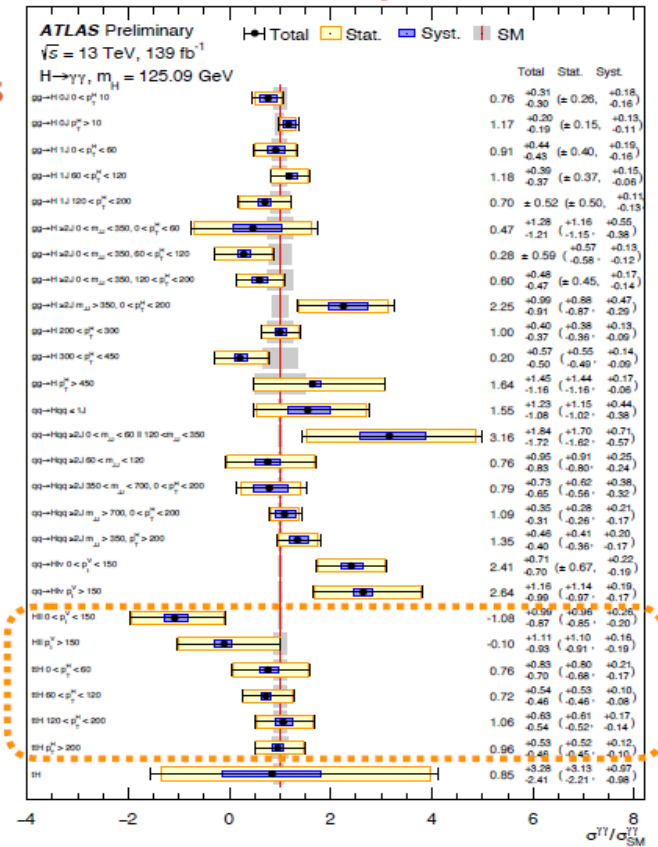
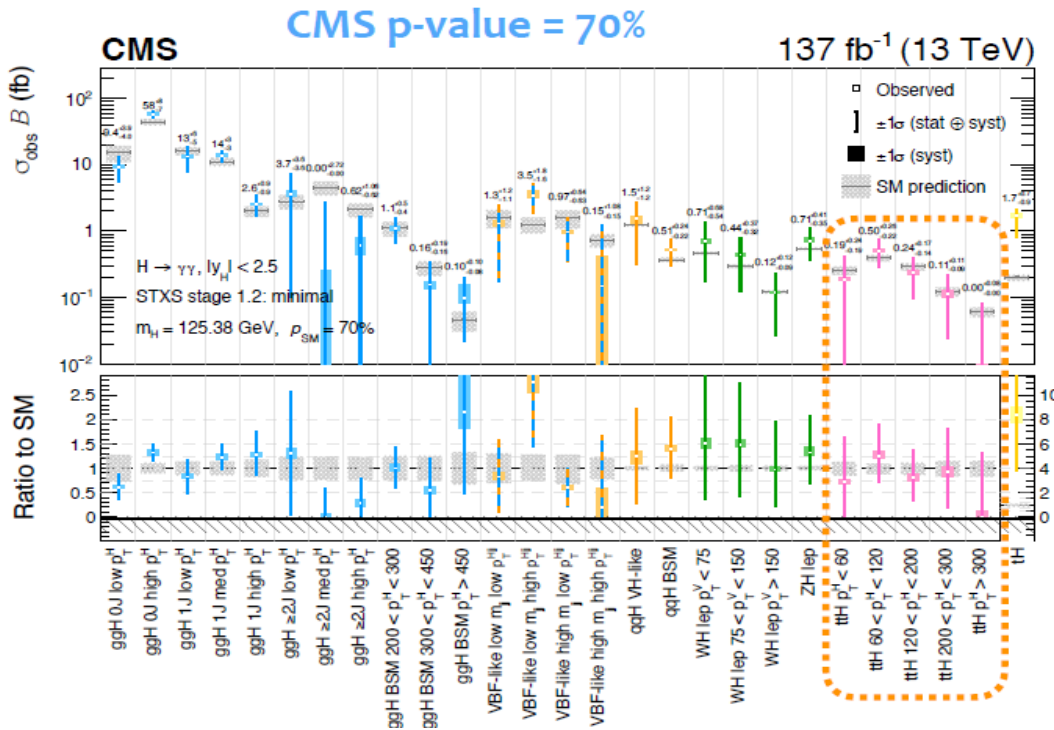

# Lepton-Photon 2021 (January 2022)

## Rare decays:

- Rare decay:  $BR(H \rightarrow \mu\mu) \approx 2 \times 10^{-4}$ , with large non-resonant background from  $DY \rightarrow \mu\mu$ 
  - all production modes used: ggF, VBF, VH, ttH, categorized to improve sensitivity

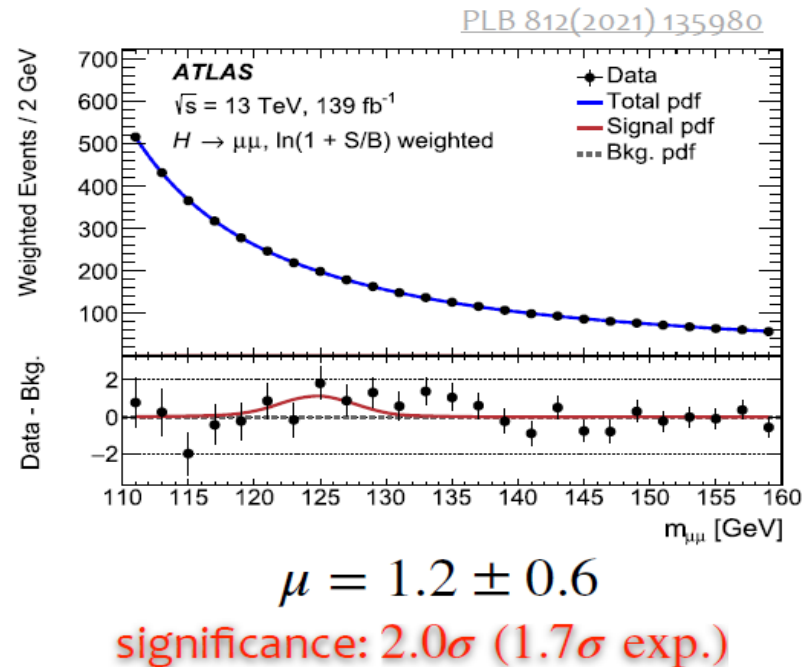
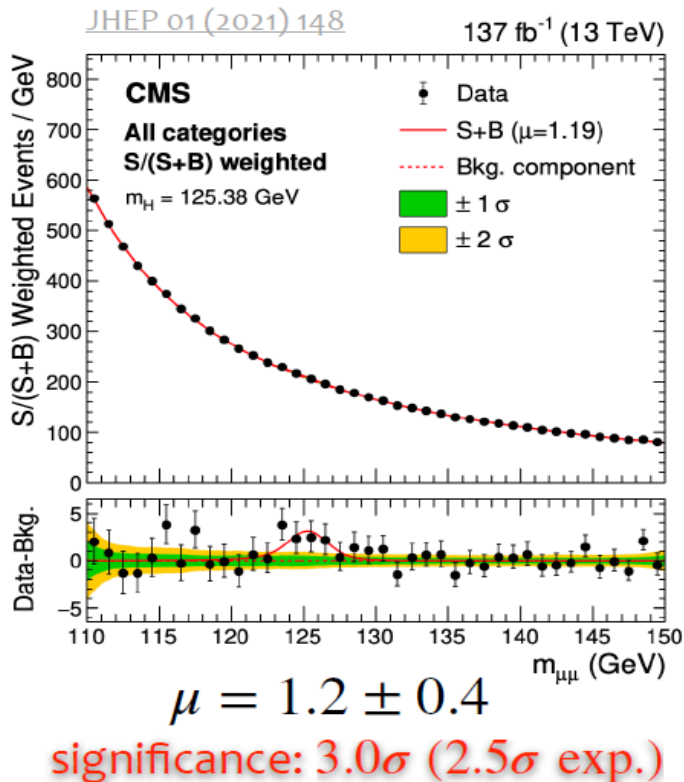



# Lepton-Photon 2021 (January 2022)

## Rare decays:

- Rare decay:  $BR(H \rightarrow \mu\mu) \approx 2 \times 10^{-4}$ , with large non-resonant background from  $DY \rightarrow \mu\mu$ 
  - all production modes used: ggF, VBF, VH, ttH, categorized to improve sensitivity

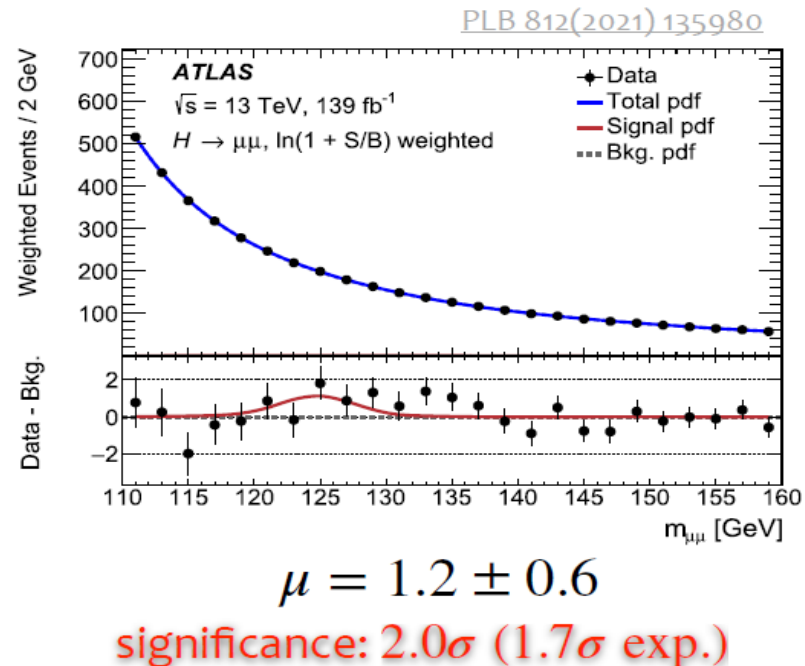
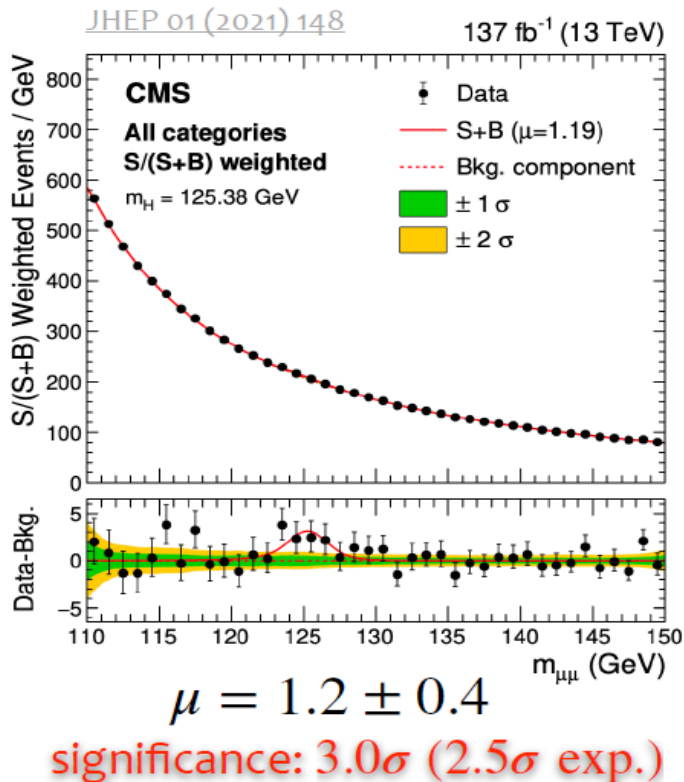

# Lepton-Photon 2021 (January 2022)

## H → μμ challenges:

- S/B ~ 0.1% for inclusive events at 125 GeV
- Strategies to increase sensitivity:
  - improve  $\sigma(m_{\mu\mu})$  with FSR recovery, constrain tracks to beam line
  - use dedicated DNN/BDT in each category
  - very accurate DY bkg modelling

[JHEP 01\(2021\)148](#)

35.9-137 fb<sup>-1</sup> (13 TeV)

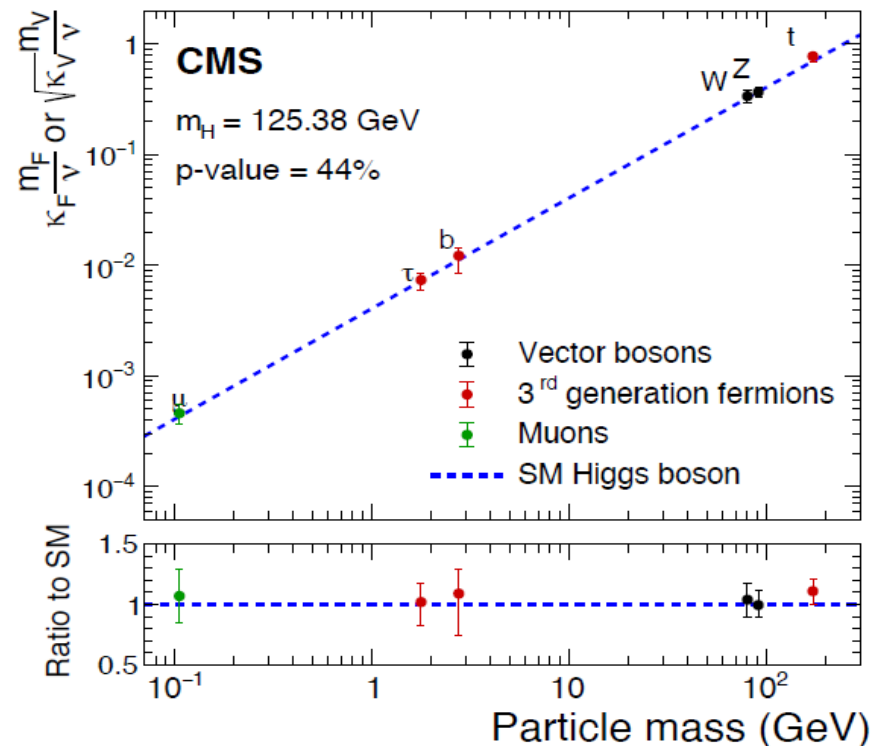
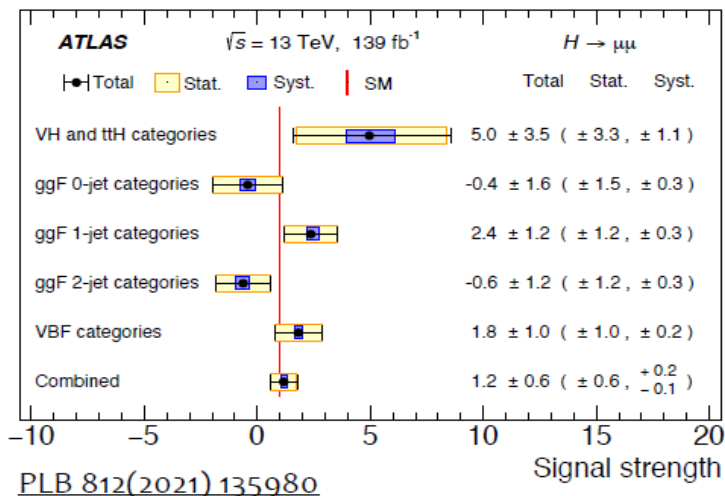

# Lepton-Photon 2021 (January 2022)

## Run II combination $\kappa$ and EFT:

- Combination also for in the  $\kappa$ -framework for the coupling modifiers
  - assuming decays to SM-only particles

$$\kappa_j^2 = \Gamma_j / \Gamma_J^{SM}$$

- e.g. universal vector-boson couplings  $\kappa_V = \kappa_W = \kappa_Z$  and universal fermion couplings  $\kappa_F = \kappa_t = \kappa_b = \kappa_\tau = \kappa_\mu$

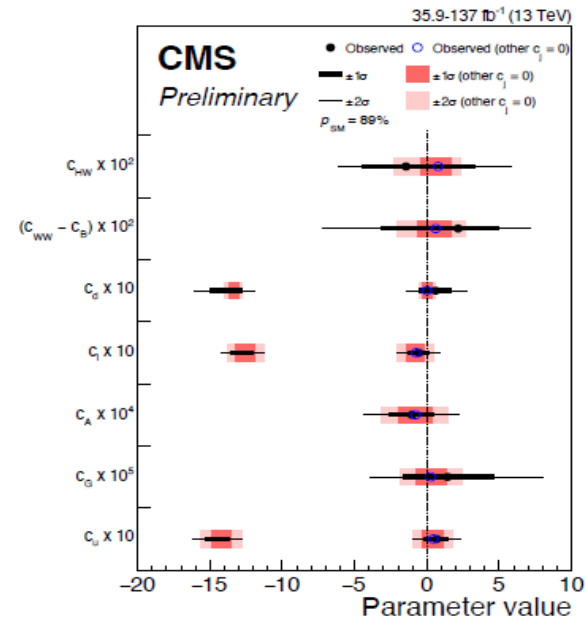
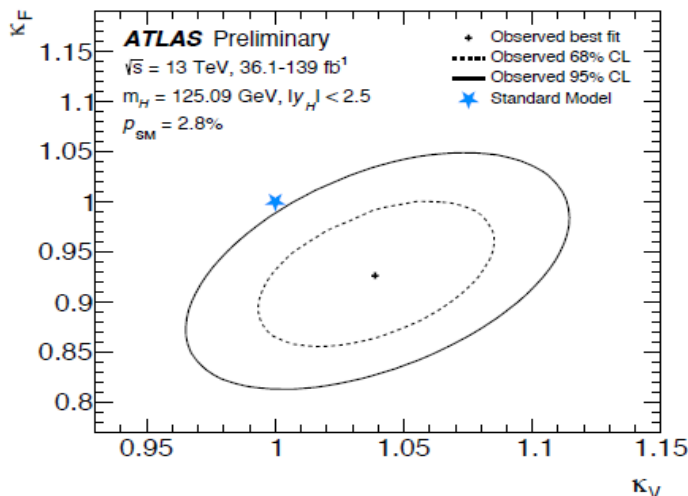

- Or EFT for BSM at a scale  $\Lambda \gg \text{VEV}^H$ : constraints of Wilson coefficients of the higher-order operators derived from STXS signal strengths  $\mu_i$  in each bin- $i$ :

$$\mu_i(c_j) = \frac{\sigma_i^{\text{EFT}}}{\sigma_i^{\text{SM}}} \quad \text{ATLAS-CONF-2021-05; CMS-PAS-HIG-19-005}$$

# Lepton-Photon 2021 (January 2022)

## Run II combination $\mu$ :

ATLAS-CONF-2021-053

CMS-PAS-HIG-19-005

- Higgs physics in the **era of precision (6% on  $\mu$ )**:
  - **ATLAS:**  $\mu = 1.06 \pm 0.06 = 1.06 \pm 0.03(\text{stat.}) \pm 0.03(\text{exp.}) \pm 0.04(\text{sig. th.}) \pm 0.02(\text{bkg. th.})$
  - **CMS:**  $\mu = 1.02^{+0.07}_{-0.06} = 1.02 \pm 0.04(\text{stat.}) \pm 0.04(\text{exp.}) \pm (\text{th.})$

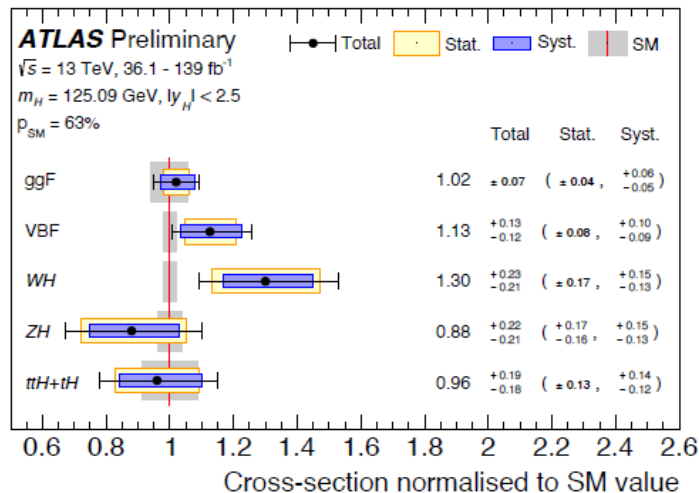

$\sigma^H / \sigma_{SM}^H$  in production

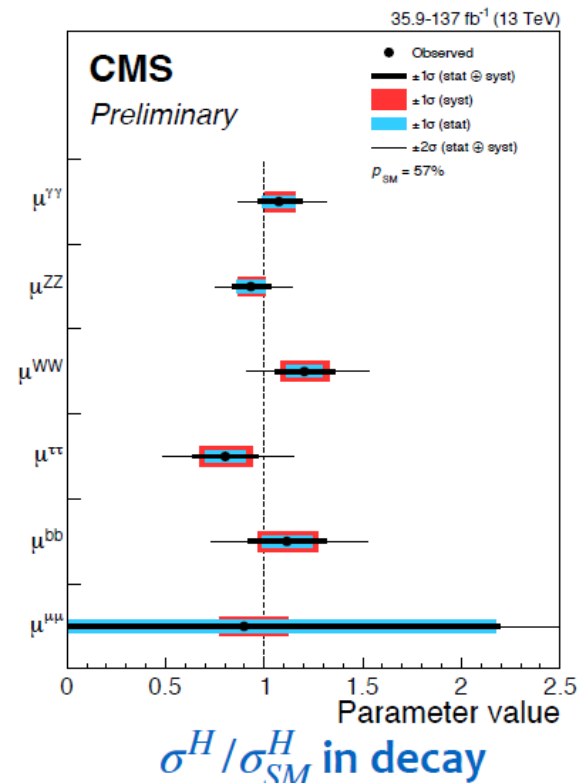

# Lepton-Photon 2021 (January 2022)

## Conclusions:

- The LHC Run2 provided data for a lot of results from ATLAS and CMS characterizing the Higgs boson
  - mass measured with 0.1% precision, and width measured for the first time with 50% precision
  - the production cross section are now measured differentially in many STXS bins, in several production modes
  - fiducial cross sections and coupling modifiers measured at 10% level, allowing interesting EFT interpretations
  - couplings to 2<sup>nd</sup> generation established with  $H \rightarrow \mu^+ \mu^-$ , next challenge is  $H \rightarrow c\bar{c}$
  - CP violation studied in many channels, including rare ttH
  - searches for HH production for H self-couplings impressive
- **The LHC is going to have new collisions in Spring 2022** with  $\sqrt{s}=13.6$  TeV and **500 fb<sup>-1</sup> is expected per experiment in Run3**
  - a unique opportunity to continue characterizing the Higgs potential: entering the precision era for the Higgs field