

Introduction to elementary particles: experimental part

Particle detection and identification:

- Particles interaction with matter
- Which particle we can detect
- The observables
- Example: ATLAS detector:
 - Tracking detectors and magnetic field
 - Muon system
 - Calorimetry
- Detectors are not perfect

Collisions at LHC

Nominal parameters

Proton-Proton	2835 bunch/beam
Protons/bunch	10^{11}
Beam energy	7 TeV (7×10^{12} eV)
Luminosity	10^{34} cm ⁻² s ⁻¹

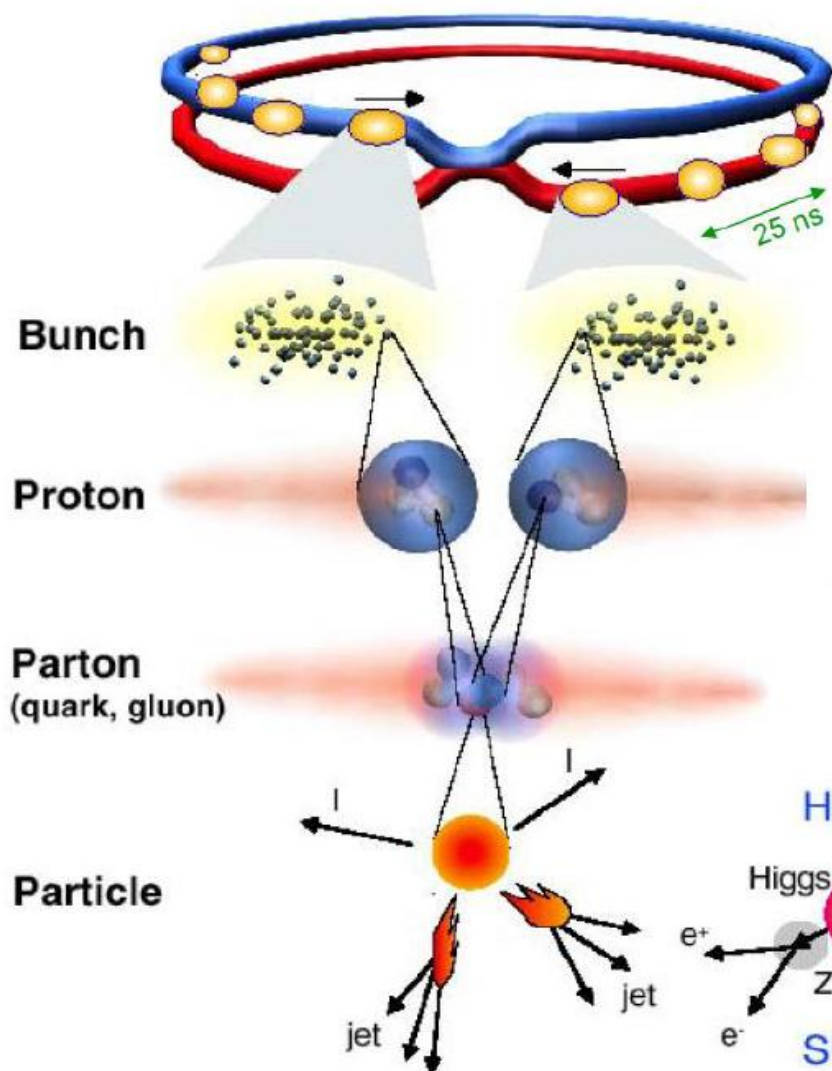

In the experiments:

10^9 pp interactions per second

~ 1500 particles (p, n, π) produced in the detectors at each bunch-crossing

**Selection of 1 in
10,000,000,000,000**

How we detect particles

- In order to detect a particle, it must:
 - ✓ interact with the material of the detector
 - ✓ transfer energy in some recognizable fashion (signal)
- Detection of particles happens via their energy loss in the material they traverses

Charged particles	Ionization, Bremsstrahlung, Cherenkov, ...	multiple interactions
Photons	Photo/Compton effect, pair production	single interactions...
Hadrons	Nuclear interactions	multiple interactions
Neutrinos		

Examples of particle interactions

Ionization:

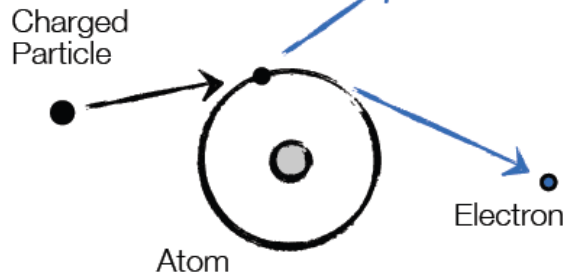
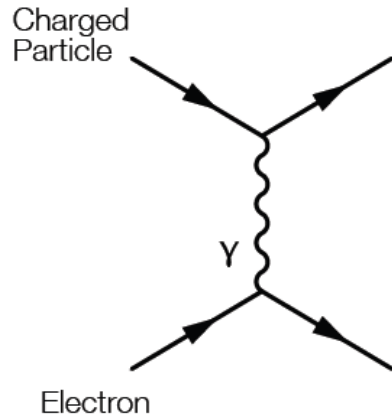

Pair production:

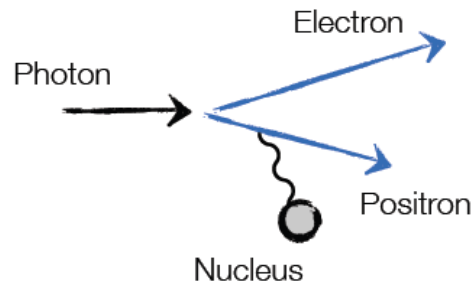
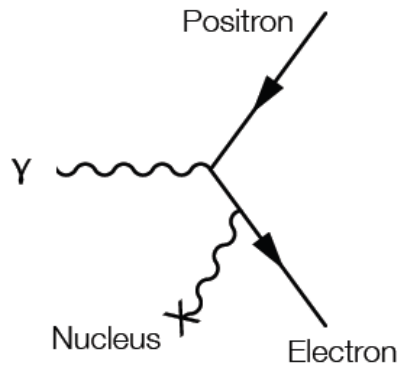

Compton scattering:

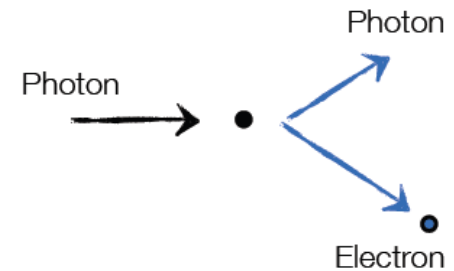
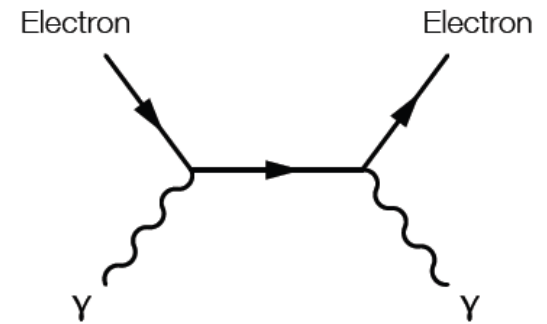

Which particles are detected?

- 1) **Charged leptons, photons and hadrons: $e, \mu, \gamma, \pi, K, p, n...$**
(maybe new long-lived particles, i.e. particles which enter detector)
- 2) **B (and D) mesons and τ leptons** have $c\tau \sim 0.09 \times 10^{-3}m$ large enough for additional vertex reconstruction
- 3) **Neutrinos** (maybe also new particles) are reconstructed as missing transverse momentum
- 4) **All other particles which decay or hadronise in primary vertex** (top quark decays before hadronises)

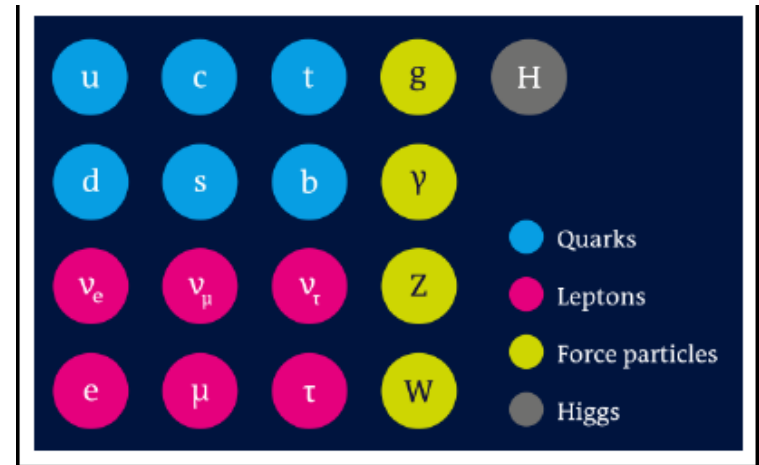

Only e, μ, γ of the fundamental Standard Model Particles are directly detected

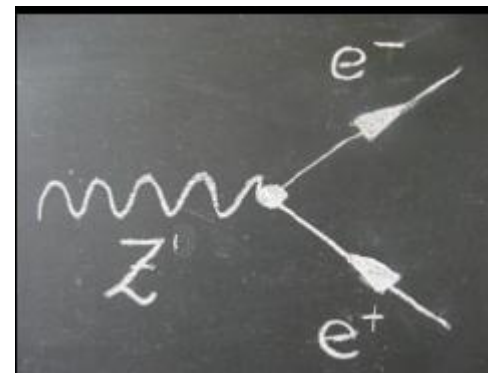

Heavy particles W, Z decay immediately

Passage of particles

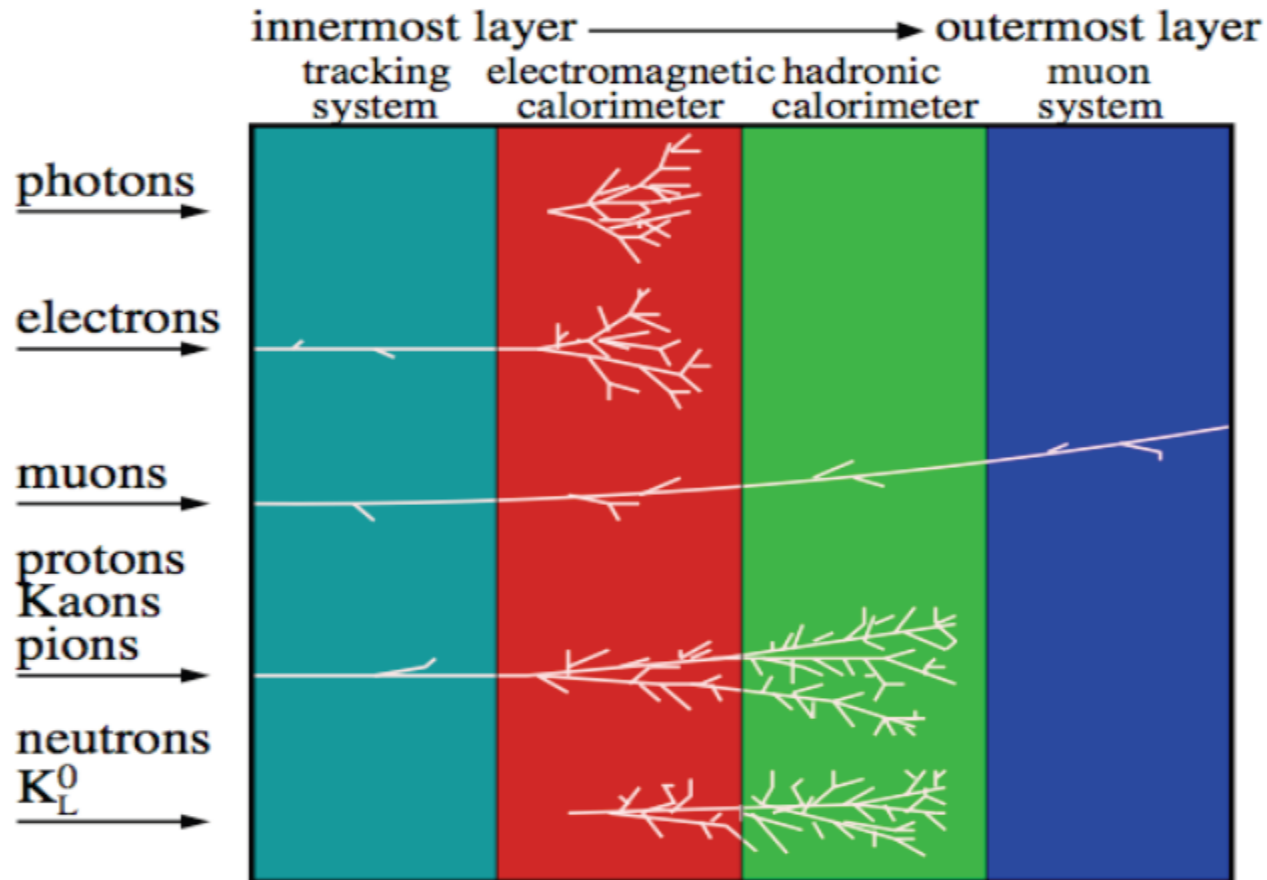

C. Lippmann – 2003

The observables?

- 1) Photon makes photo-effect, Compton scattering and **pair production**. It has no track but an **electromagnetic cascade** in the calorimeter.
- 2) Charged particles makes scattering, **ionisation**, excitation and bremsstrahlung, transition and Cherenkov radiation. They produce **tracks**.
- 3) Electrons make **electromagnetic cascades** (clusters) in the calorimeter
- 4) Hadrons also interact strongly via inelastic interactions, e.g. neutron capture, induced fission, etc. They make **hadronic cascades** (clusters) in the hadronic calorimeter.
- 5) Only weakly interacting particles (neutrinos) are reconstructed as **missing transverse momentum** („missing energy”).

The ATLAS example

Typical 4π cylindrical onion structure

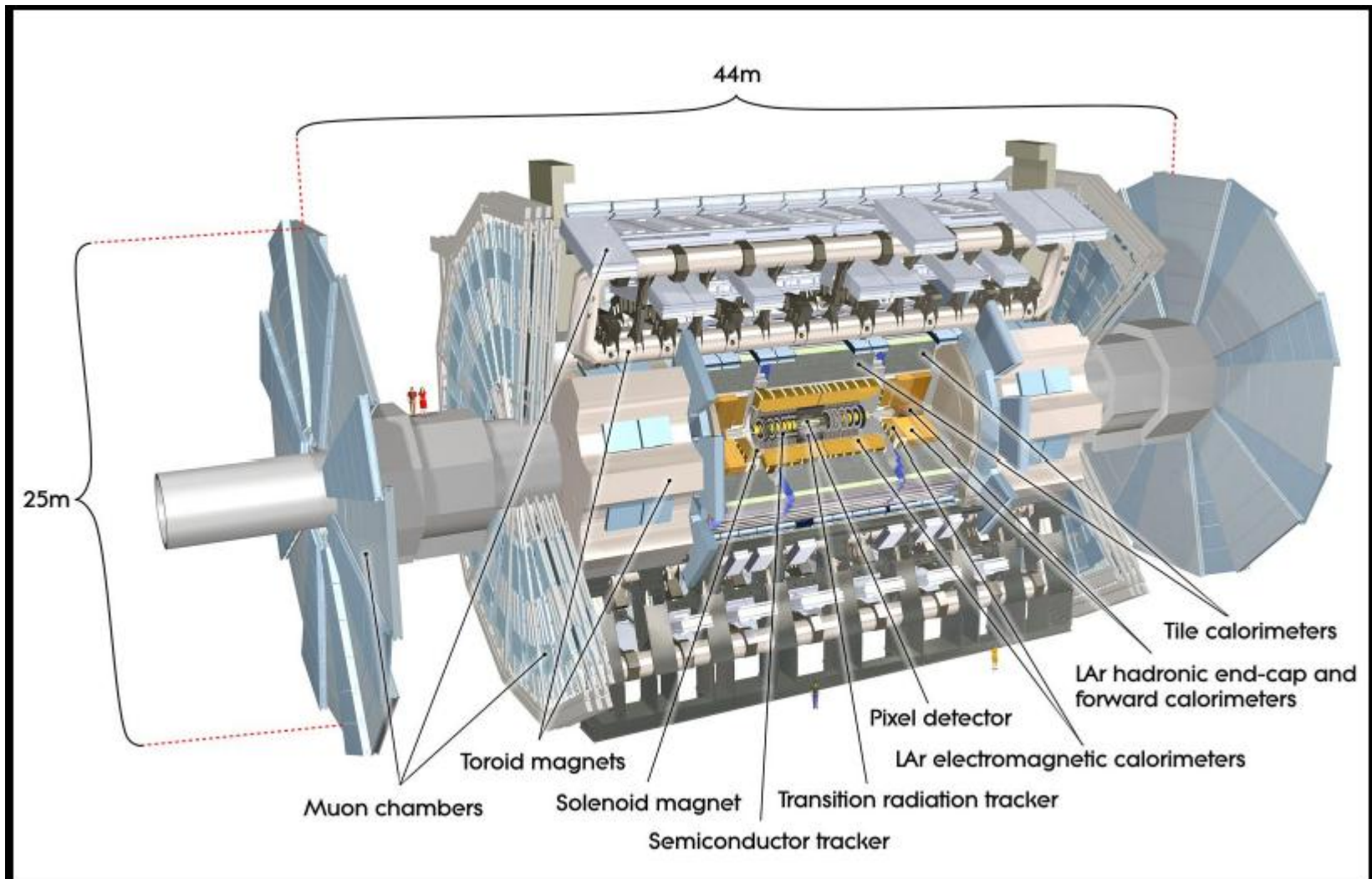

How do we “see” particles?

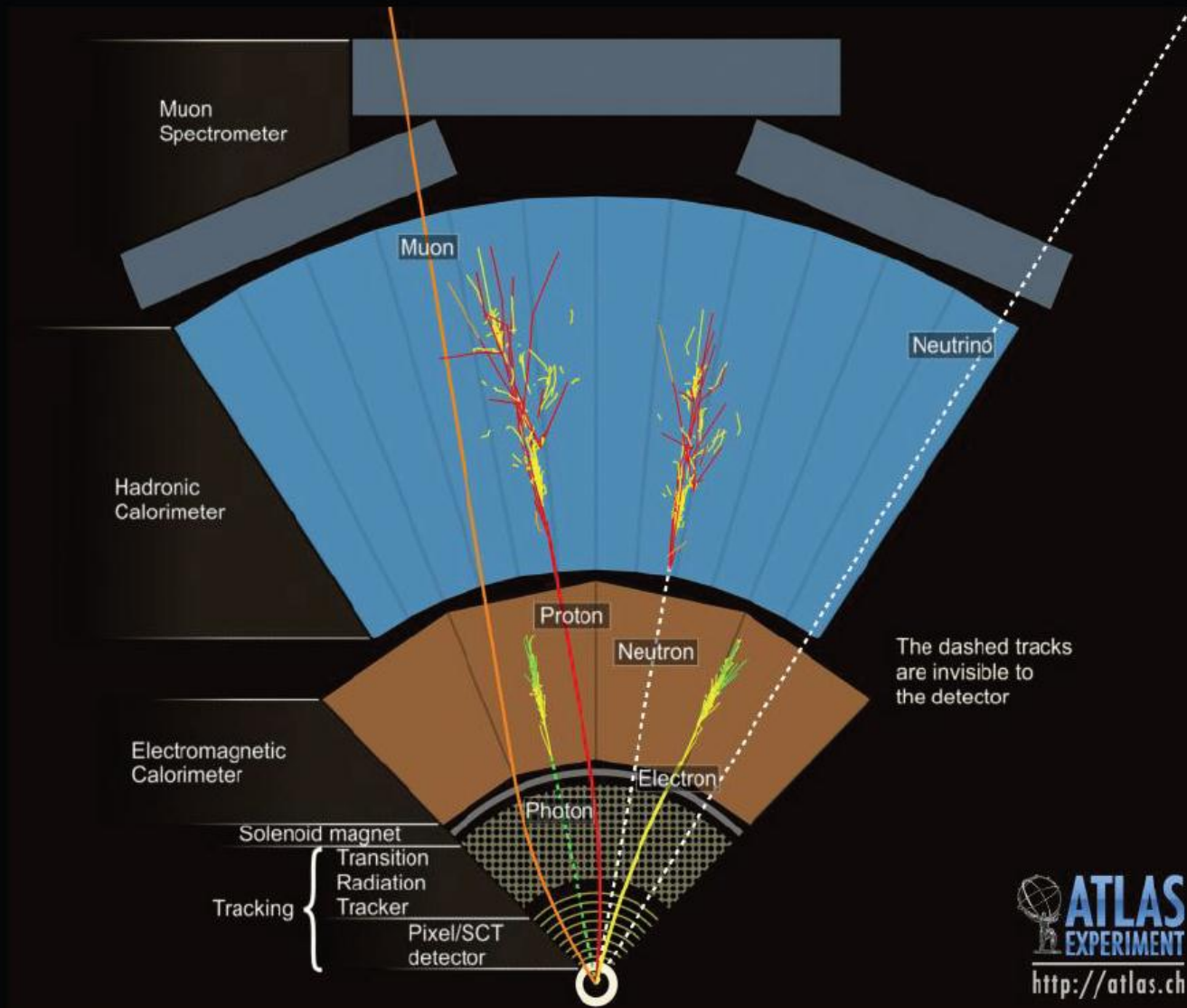

Reconstructed particle properties

From the hits, tracks, clusters, missing transverse momentum and vertices we reconstruct particles properties:

- 1) **Momentum** from curved tracks
- 2) **Charge** from track curvature
- 3) **Energy** from full absorption in calorimeters and curved tracks
- 4) **Spin** from angular distributions
- 5) **Mass** from invariant mass of decay products
- 6) **Lifetime** from time of flight measurement
- 7) **Identity** from dE/dx , lifetime or special behaviour (like transition radiation)

Detector design constraints (I)

- **Constraints from physics:**
 - 1) High detection efficiency demands minimal cracks and holes, high coverage
 - 2) High resolution demands little material like support structures, cables, cooling pipes, electronics etc. (avoid multiple scattering)
 - 3) Irradiation hard active materials required to avoid degradation and changes during operation
 - 4) Electronic with low noise
 - 5) Easy maintenance (materials get radioactive)
 - 6) ...

Example for resolution requirement

Excellent energy resolution
of EM calorimeters for e/γ and
of the tracking devices for μ in
order to extract a signal over the
backgrounds.

Example : $H \rightarrow \gamma \gamma$

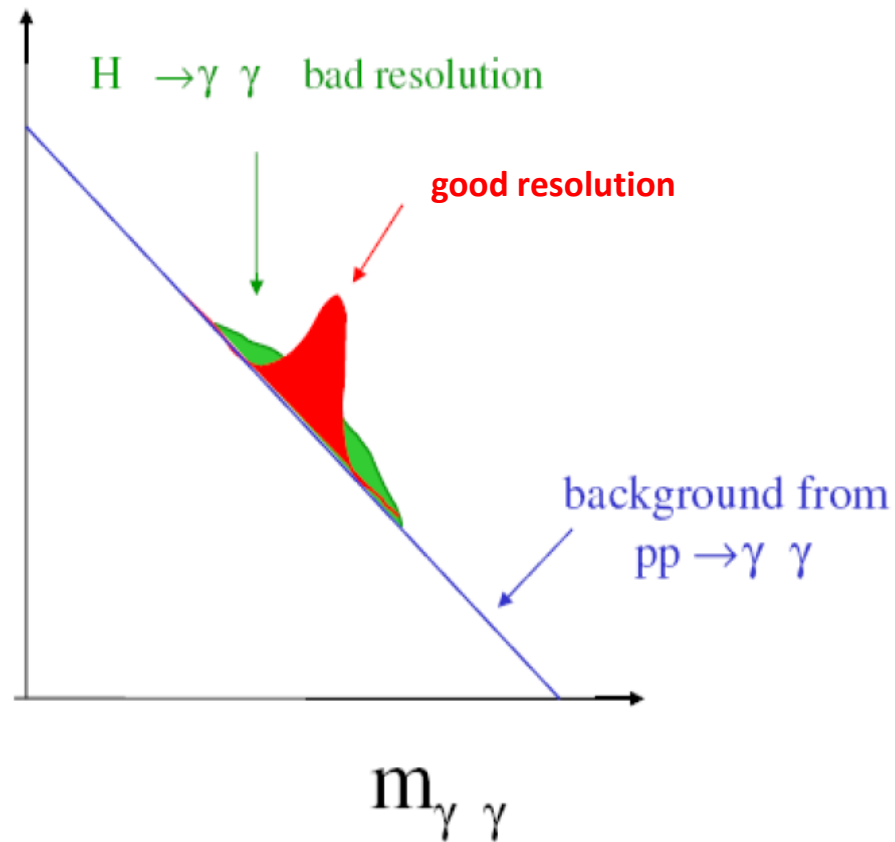

Example for particle ID requirement

Excellent particle identification capability e.g. e/jet , γ/jet separation



number and p_T of hadron in a jet have large fluctuations



in some cases: one high- p_T π^0 ; all other particles too soft to be detected

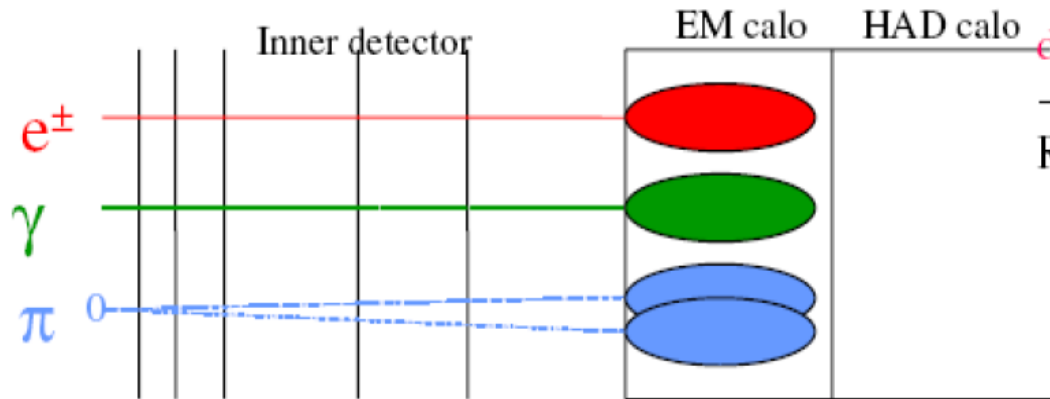

$d(\gamma \gamma) < 10 \text{ mm}$ in calorimeter
 \rightarrow QCD jets can mimic photons.
 Rare cases, however:

$$\frac{\sigma_{jj}}{\sigma(H \rightarrow \gamma\gamma)} \sim 10^8$$

$$m_{\gamma\gamma} \sim 100 \text{ GeV}$$

need detector (calorimeter) with fine granularity to separate overlapping photons from single photons

Detector design constraints (II)

- **Environmental constraints, i.e. from LHC design parameters:**

- 1) Collision events every $\sim 25\text{ns}$
- 2) Muons from previous event still in detector when current enters tracker
- 3) High occupancy in the inner detector
- 4) Pile up (more proton proton collisions in each bunch crossing)
- 5) High irradiation
- 6) ...

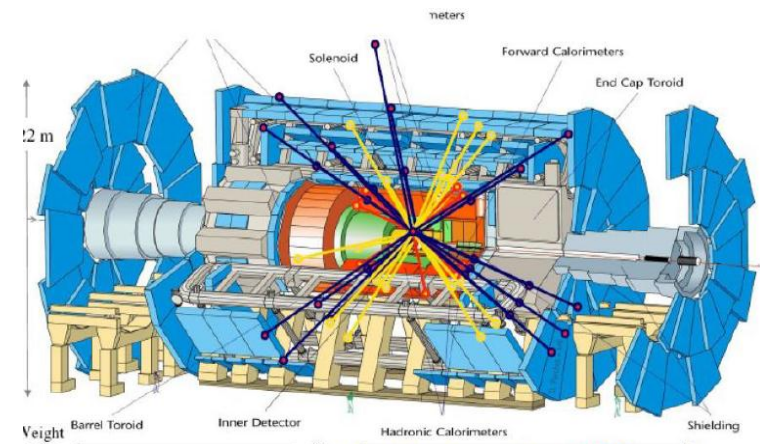
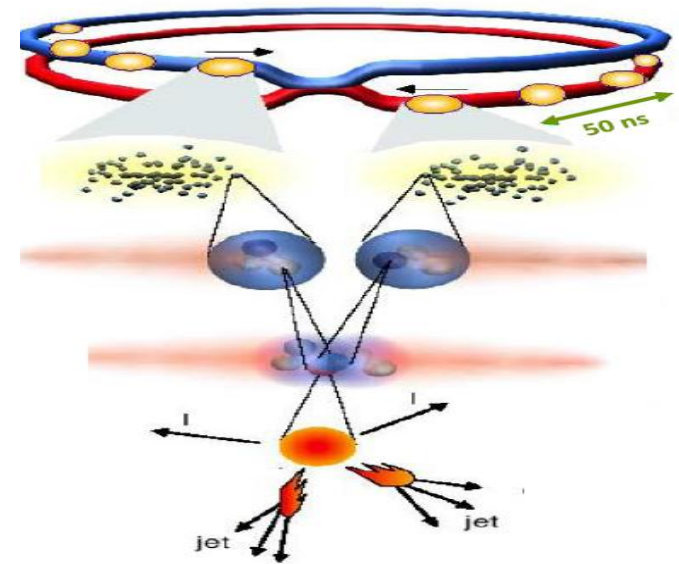

Trigger system

- Interactions every **25 ns** ...
 - In 25 ns particles travel **7.5 m**
 $c=30\text{cm/ns}$; in 25ns, $s=7.5\text{m}$

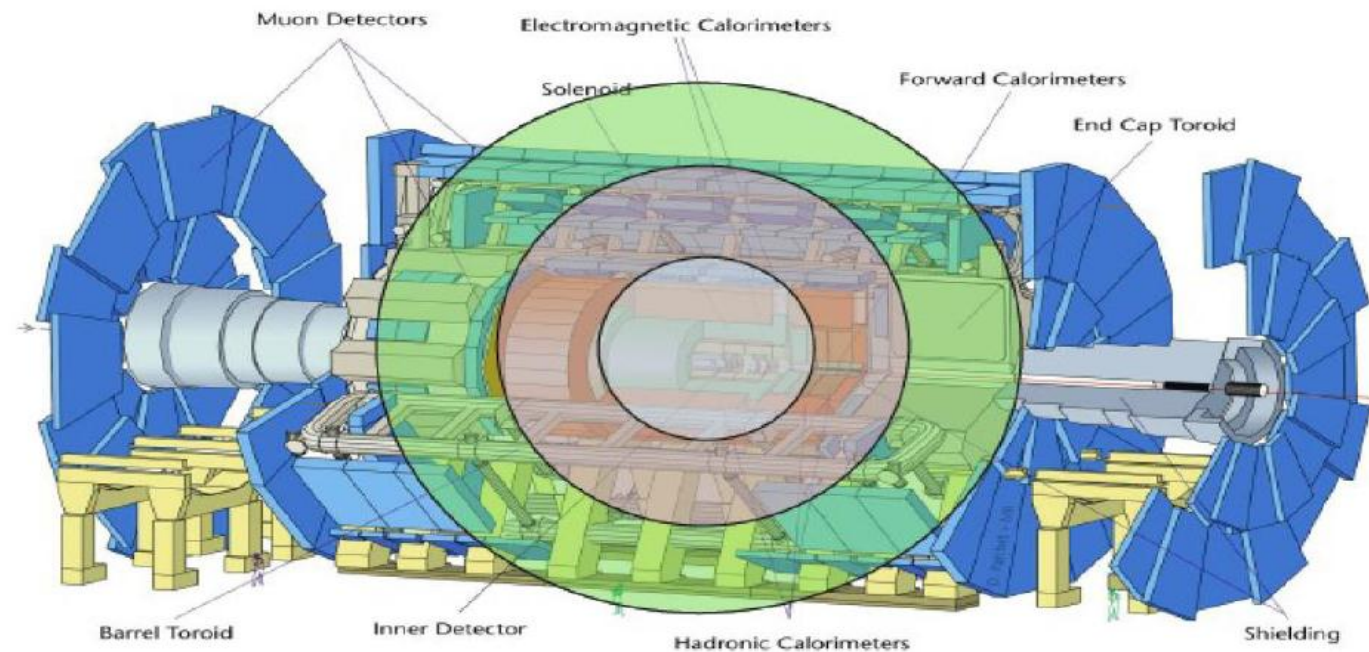

: 7000
t

44 m

- Cable length **~100 meters** ...

- In 25 ns signals travel **5 m**

Trigger system

Jak w ciągu 1 sekundy wybrać 1 spośród 10^7 ?

Co to znaczy niewielka część?

- $25\text{ns} \Rightarrow 40 \times 10^6/\text{s}$ zderzeń
- 23 oddział/zderzenie $\Rightarrow 23 \times 40 \times 10^6 /\text{sek} \sim 10^9 /\text{sek}$ oddział
- możemy zarejestrować tylko $\sim 100/\text{sek}$ zderzeń \Rightarrow **redukcja 10^7**

Ile informacji trzeba przetworzyć?

trigger elektron: $8\text{bit} \times 40\text{MHz} \times 7500 \sim 3\,000$ Gbit/sek

Czy można podjąć decyzje w 25ns?

nie można:

czas rejestracji w detektorze dłuższy (ok. $50 \times 25\text{ns}$)
informacje trzeba wysłać do procesora (ok. $15 \times 25\text{ns}$)
informacje trzeba przetworzyć (ok. $10 \times 25\text{ns}$)

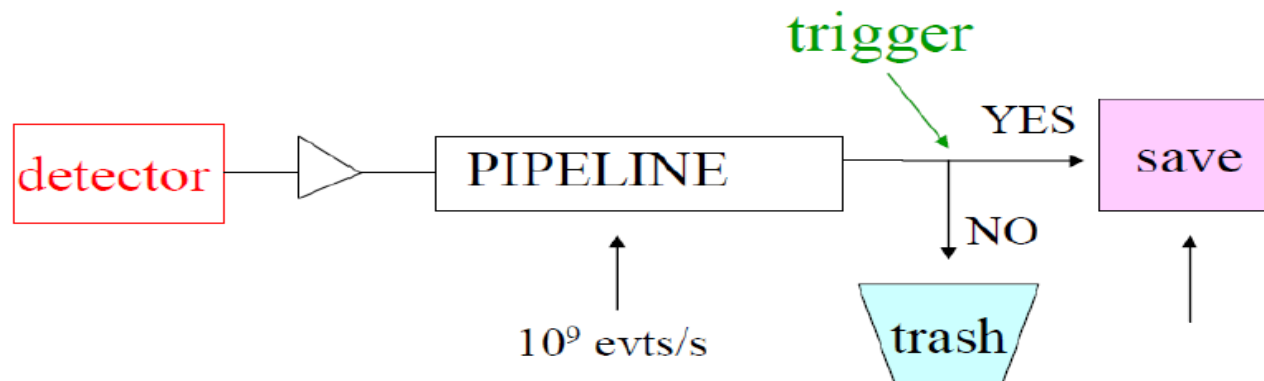

The ATLAS trigger system

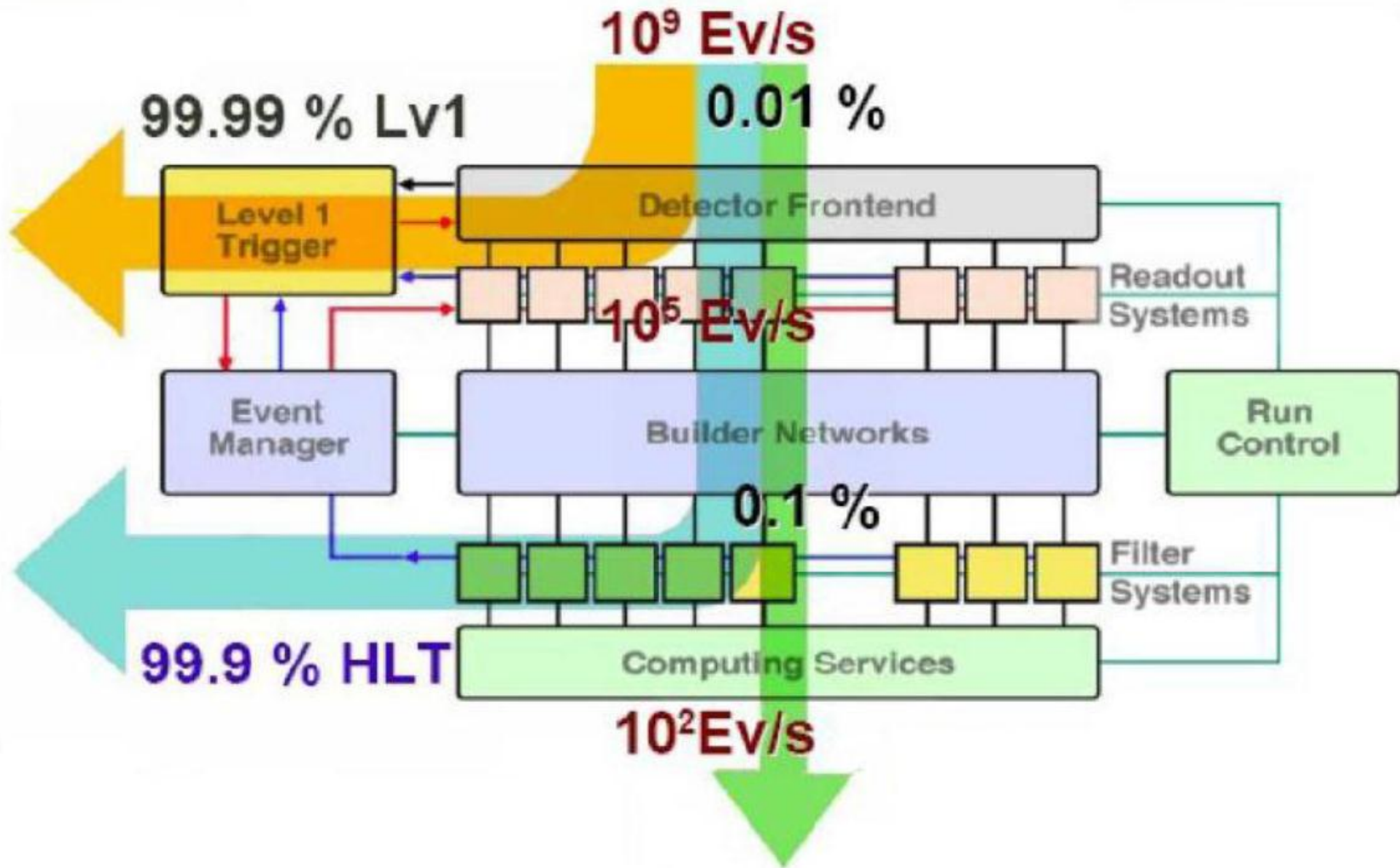

The ATLAS trigger system

Rate (2012 conditions)

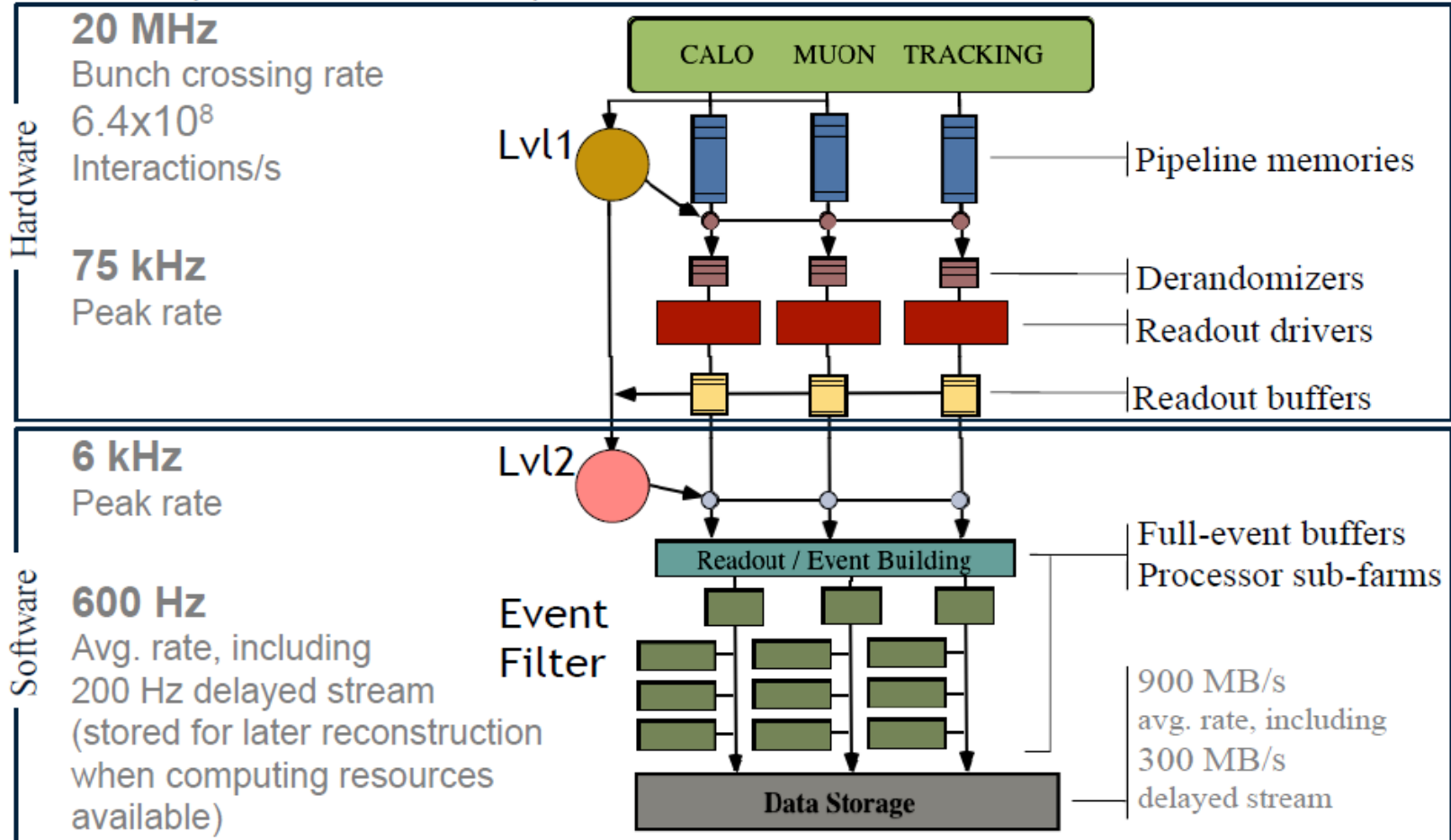

Magnet system

- Use Lorentz force to curve tracks

$$\vec{F} = q\vec{E} + q\vec{v} \times \vec{B}$$

Electric force
Magnetic force

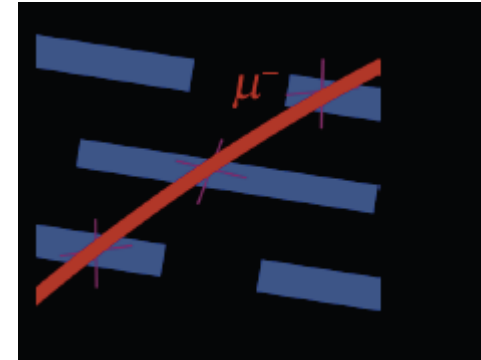

- Max E is about 50MV/m in high vacuum, so just B field used (5T gives $\sim 10^3$ stronger force)

- Curvature or radius:

$$q v B = m v^2 / T \Rightarrow p = q B R$$

- At least three hits needed to reconstruct a unique R of a track

- Remember solenoid resolution:

$$(\Delta p/p)_{\text{solenoid}} \sim (\Delta s / L^2 B) p$$

(in GeV with s in μm , L in cm and B in T. Large B is good against high occupancy.)

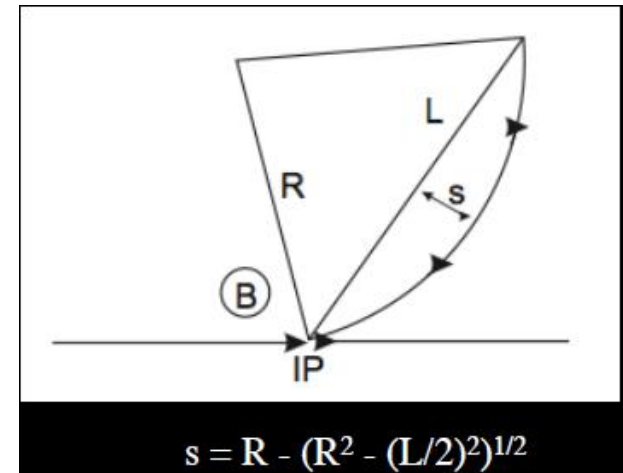

s = sagitta

Charged particle in magnetic field

Lorentz force:

$$\vec{F} = q\vec{v} \times \vec{B}$$



$$P \sim 0.3 \cdot R \cdot B \quad R \rightarrow \frac{1}{S}$$

P : momentum (GeV)

R : curvature (m)

B : Magnetic field (Tesla)

- Charged track => signal in detectors
- => reconstruction program
- => Sagitta (=1/R) determination

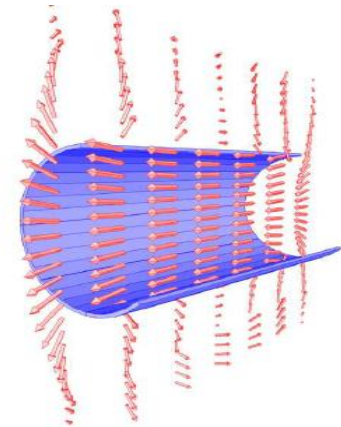

Solenoid (ATLAS Inner Tracker)

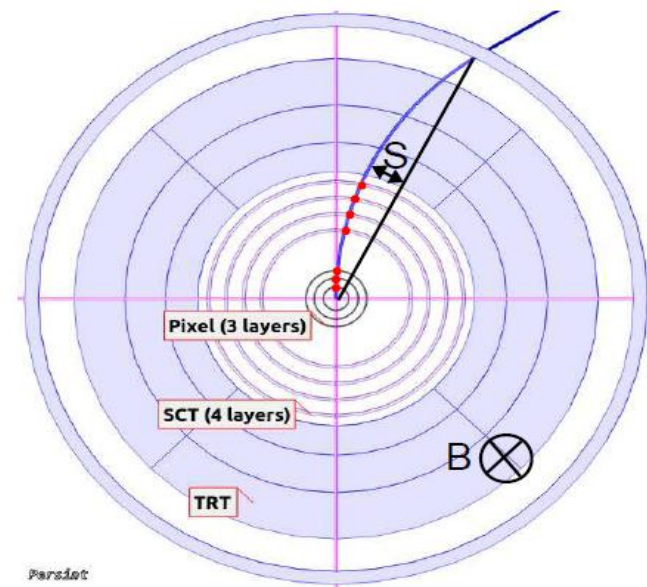

Parsdot

Charged particle in magnetic field

Lorentz force:

$$\vec{F} = q\vec{v} \times \vec{B}$$



$$P \sim 0.3 \cdot R \cdot B \quad R \rightarrow \frac{1}{S}$$

P : momentum (GeV)
 R : curvature (m)
 B : Magnetic field (Tesla)

Charged track => signal in detectors
=> reconstruction program
=> Sagitta (=1/R) determination

Reconstruction can be complicated

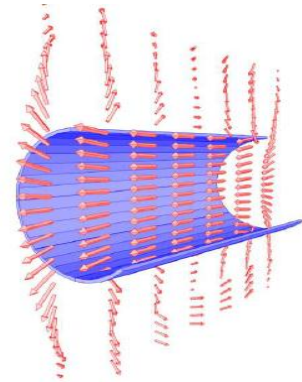

Solenoid (ATLAS Inner Tracker)

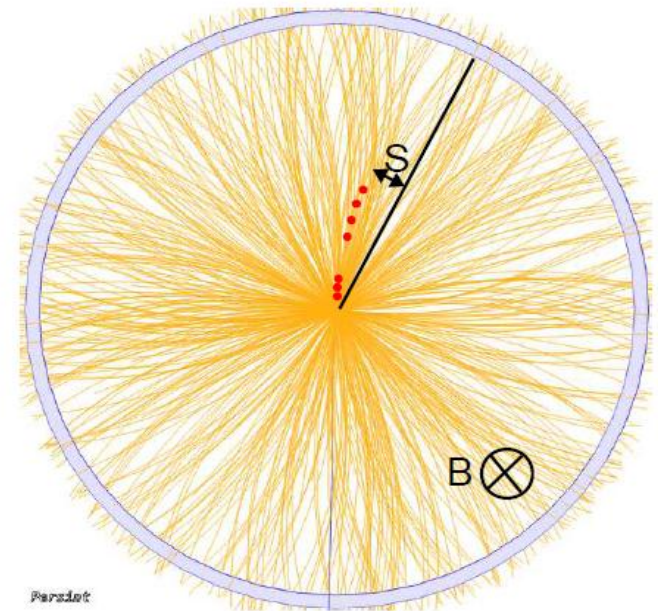

Most common magnet designs

Solenoid (A)

Deployed in ATLAS and CMS

$$(dp/p)_{\text{solenoid}} \sim p \cos \theta / BR^2$$

$$\text{cost} \sim LR^2B^2$$

Toroid (B)

Deployed in ATLAS

$$(dp/p)_{\text{toroid}} \sim p \cos \theta /$$

$$B_{\text{in}} R_{\text{in}} \ln(R_{\text{out}}/R_{\text{in}})$$

Dipole (C)

Used in fixed target / forward experiments.

Deployed in ALICE and LHCb.

$$(dp/p)_{\text{dipole}} \sim p / BL$$

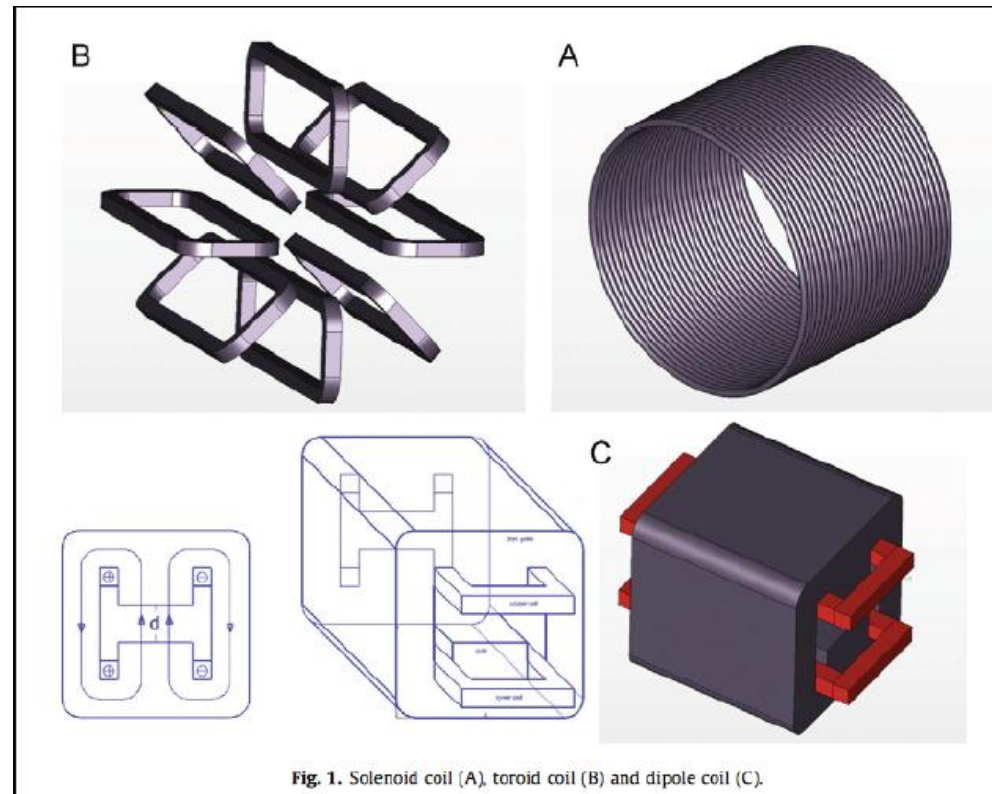
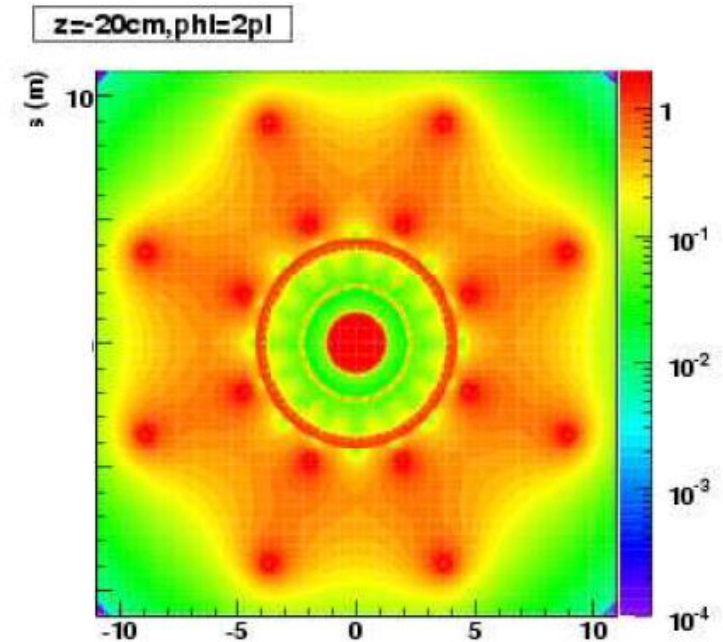
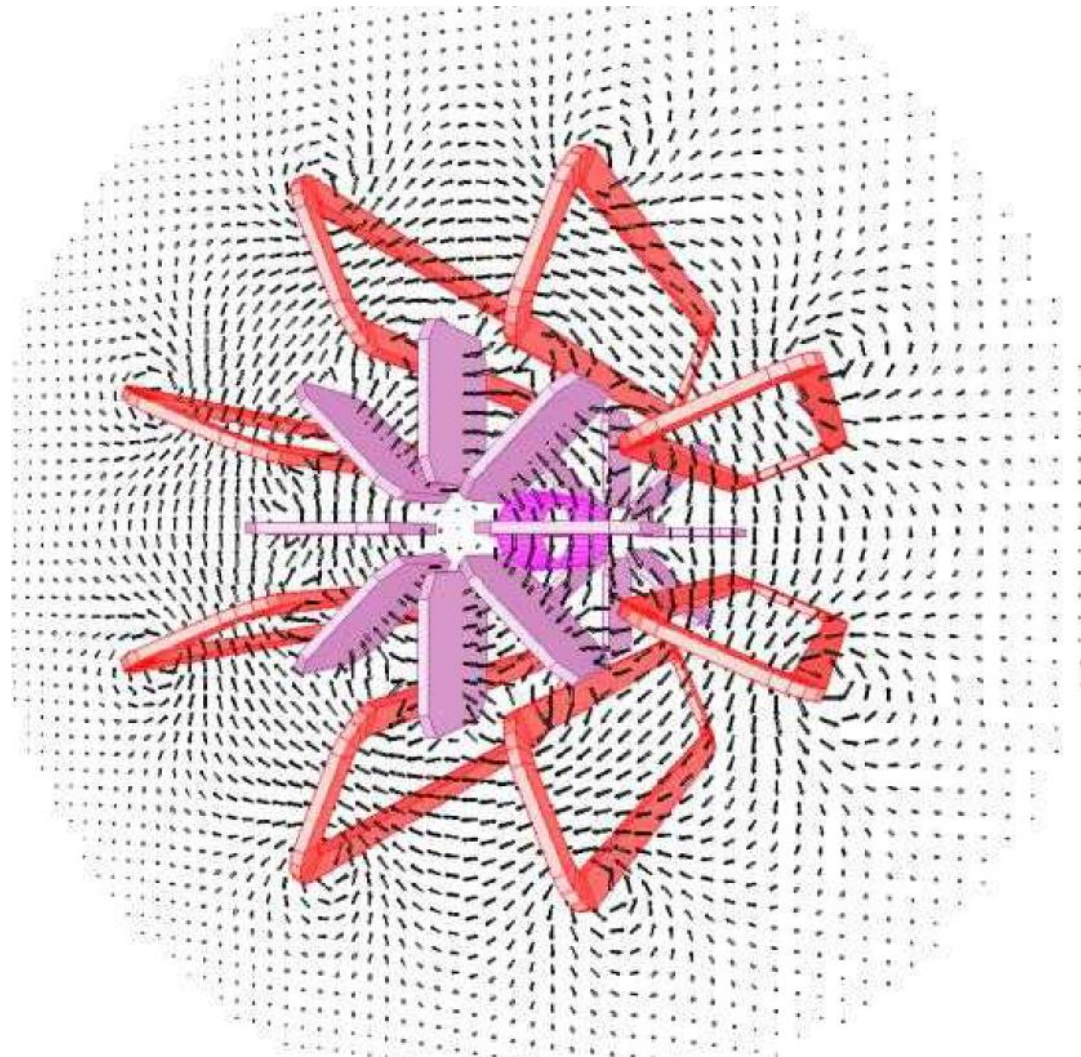

Fig. 1. Solenoid coil (A), toroid coil (B) and dipole coil (C).

Charged particle in magnetic field



ATLAS magnetic field
1 solenoid
3 toroids

Charged particle in magnetic field

ATLAS magnetic field

1 solenoid

3 toroids

R- ϕ projection

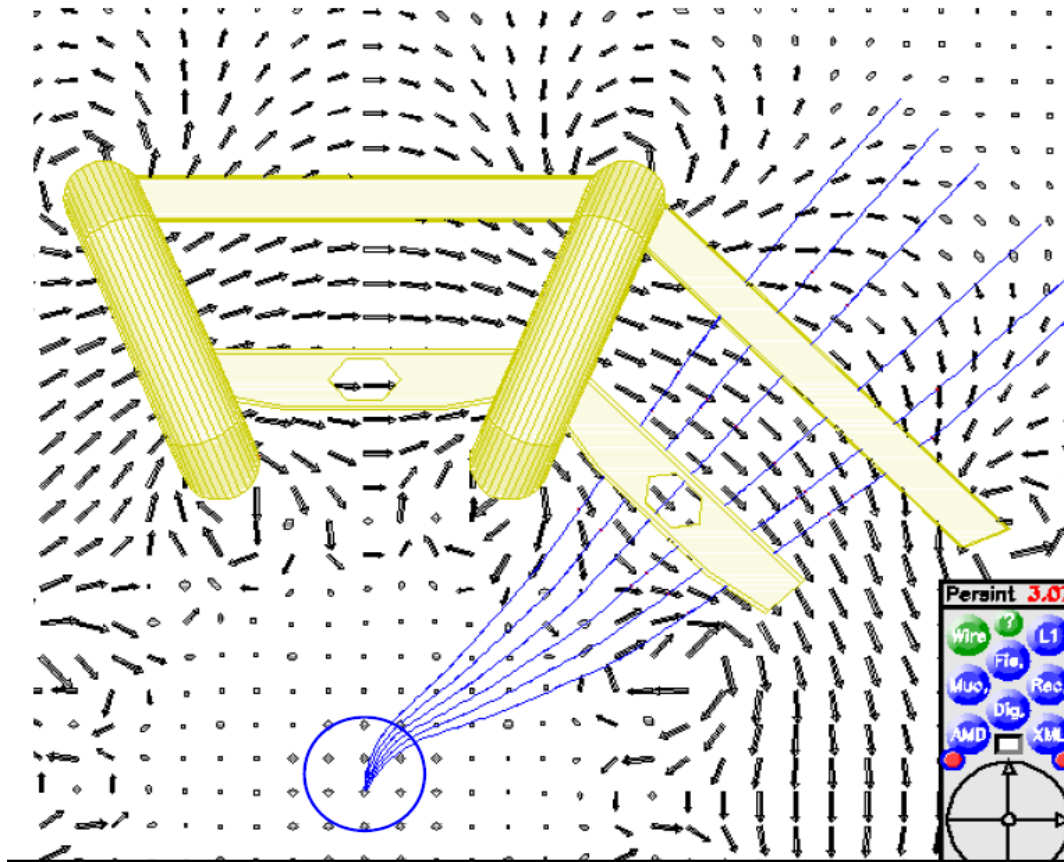

R-Z projection

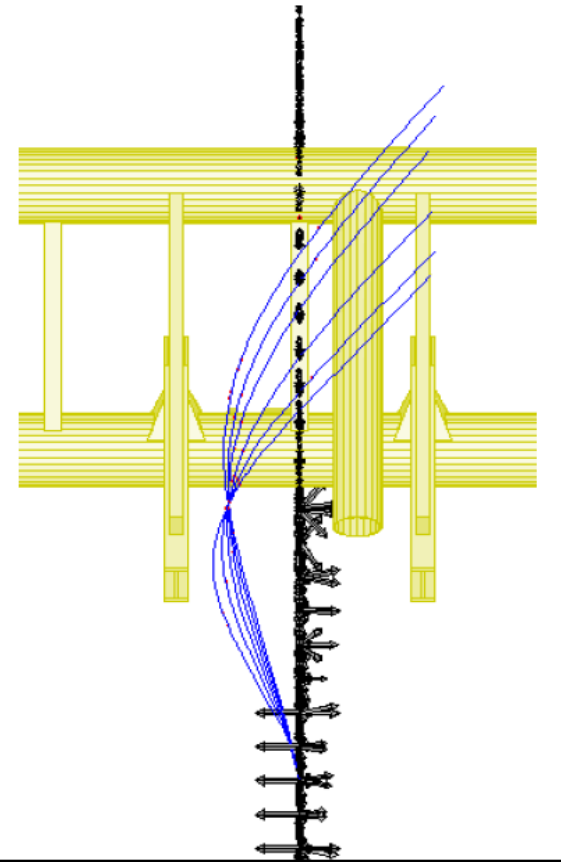

Size and field examples

ATLAS barrel toroid 20.5 kA, 3.9 T

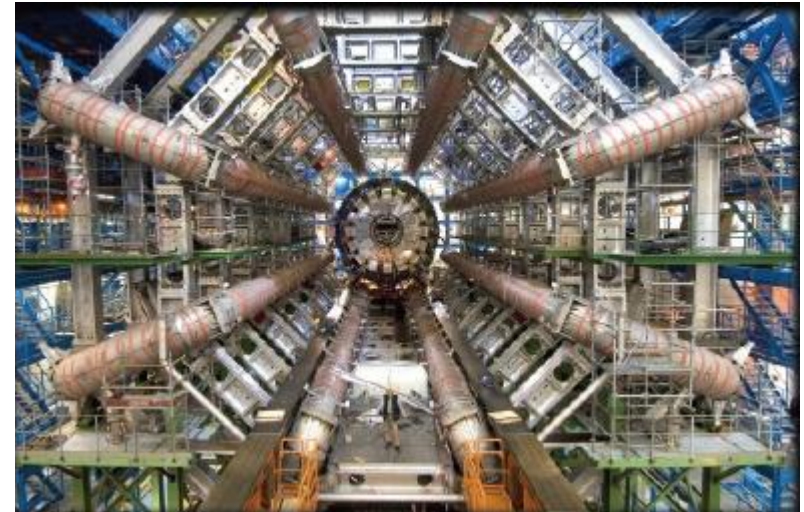

Table 1

Main parameters of some HEP detector magnets (solenoids).

	CDF	CLEO-II	ALEPH	ZEUS	H1	KLOE	BaBar	Atlas	CMS
B (T)	1.5	1.5	1.5	1.8	1.2	0.6	1.5	2.0	4.0
R (m)	1.5	1.55	2.7	1.5	2.8	2.6	1.5	1.25	3.0
L (m)	4.8	3.5	6.3	2.45	5.2	3.9	3.5	3.66	12.5

The magnet layout is a major constraint for the rest of the detector!

See A. Gadi, A magnet system for HEP experiments, NIMA 666 (2012) 10-24

Tracking principles

- Exploit physical processes of moving charged particles in the magnetic field:

1) **Ionisation** (Bethe-Bloch) is the main detection process for heavy particles ($m > m_e$)

- Collect the charges with an electric field => hits
- Reconstruct tracks from hits in B field => **p_T , vertices, isolation**

2) Bremsstrahlung is the main process for e^\pm above some 100 MeV

3) Multiple scattering (unwanted, degrades the resolution)

4) Irradiation damage (unwanted, degrades efficiency)

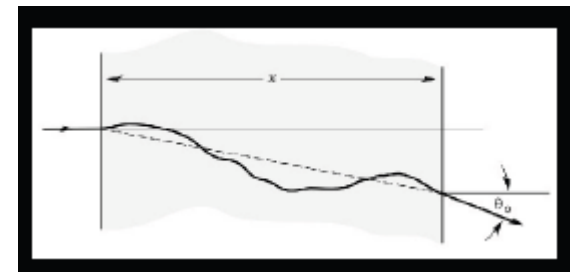
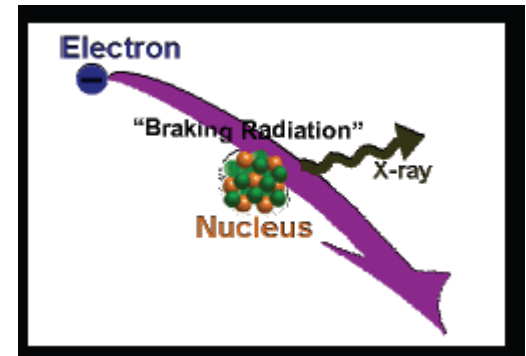
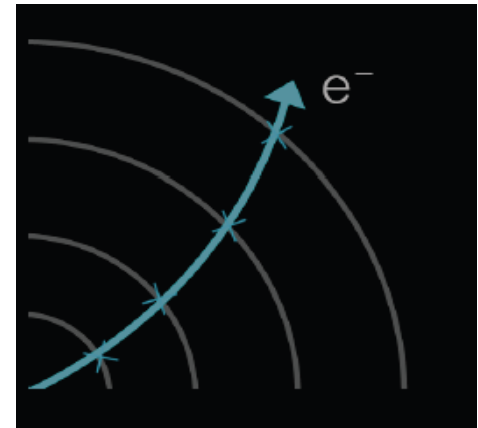

Bethe-Bloch formula for heavy particles

Describes stopping power of heavy charged (heavier than electron) particle in matter [MeV g⁻¹ cm²]

$$\beta = v/c, \gamma = (1-\beta^2)^{1/2}$$

$$-\frac{dE}{dx} = 4\pi N_A r_e^2 m_e c^2 z^2 \frac{Z}{A} \frac{1}{\beta^2} \left[\frac{1}{2} \ln \left(\frac{2m_e c^2 \beta^2 \gamma^2 T_{max}}{I^2} \right) - \beta^2 - \frac{\delta(\gamma)}{2} \right]$$

The energy loss depends only on **charge z** and **velocity β** of the particle

Rest is material dependent: I = mean ionisation/excitation energy [MeV], δ density effect correction, T_{max} is maximum energy transfer in one collision.

Bethe-Bloch formula for heavy particles

[see e.g. PDG 2010]

$$-\left\langle \frac{dE}{dx} \right\rangle = K z^2 \frac{Z}{A} \frac{1}{\beta^2} \left[\frac{1}{2} \ln \frac{2m_e c^2 \beta^2 \gamma^2 T_{\max}}{I^2} - \beta^2 - \frac{\delta(\beta\gamma)}{2} \right]$$

[· ρ]

density

$$K = 4\pi N_A r_e^2 m_e c^2 = 0.307 \text{ MeV g}^{-1} \text{ cm}^2$$

$$T_{\max} = 2m_e c^2 \beta^2 \gamma^2 / (1 + 2\gamma m_e/M + (m_e/M)^2)$$

[Max. energy transfer in single collision]

z : Charge of incident particle

M : Mass of incident particle

Z : Charge number of medium

A : Atomic mass of medium

I : Mean excitation energy of medium

δ : Density correction [transv. extension of electric field]

$$N_A = 6.022 \cdot 10^{23}$$

[Avogadro's number]

$$r_e = e^2 / 4\pi\epsilon_0 m_e c^2 = 2.8 \text{ fm}$$

[Classical electron radius]

$$m_e = 511 \text{ keV}$$

[Electron mass]

$$\beta = v/c$$

[Velocity]

$$\gamma = (1 - \beta^2)^{-2}$$

[Lorentz factor]

Validity:

$$.05 < \beta\gamma < 500$$

$$M > m_\mu$$

Muon energy loss

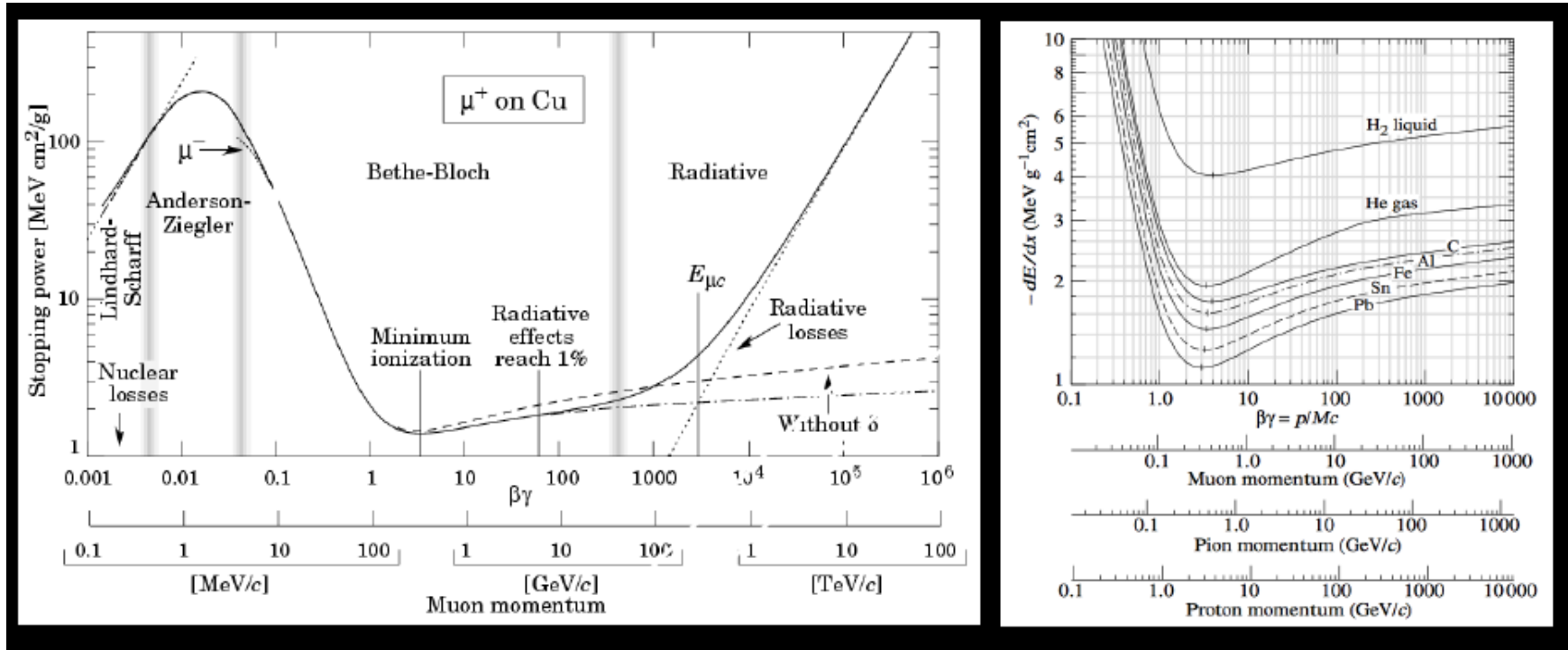

Ionization

Bremsstrahlung

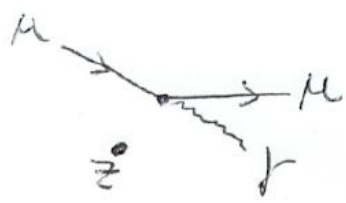

At low β : $dE/dx \sim 1/\beta^2$

Minimum at $\beta\gamma \sim 3.4$ (minimal ionizing particle)

At high β : dE/dx slowly increasing due to relativistic enhancement of transversal E field.

At very high β : saturation due to shielding/polarisation

Identifying particles by dE/dx

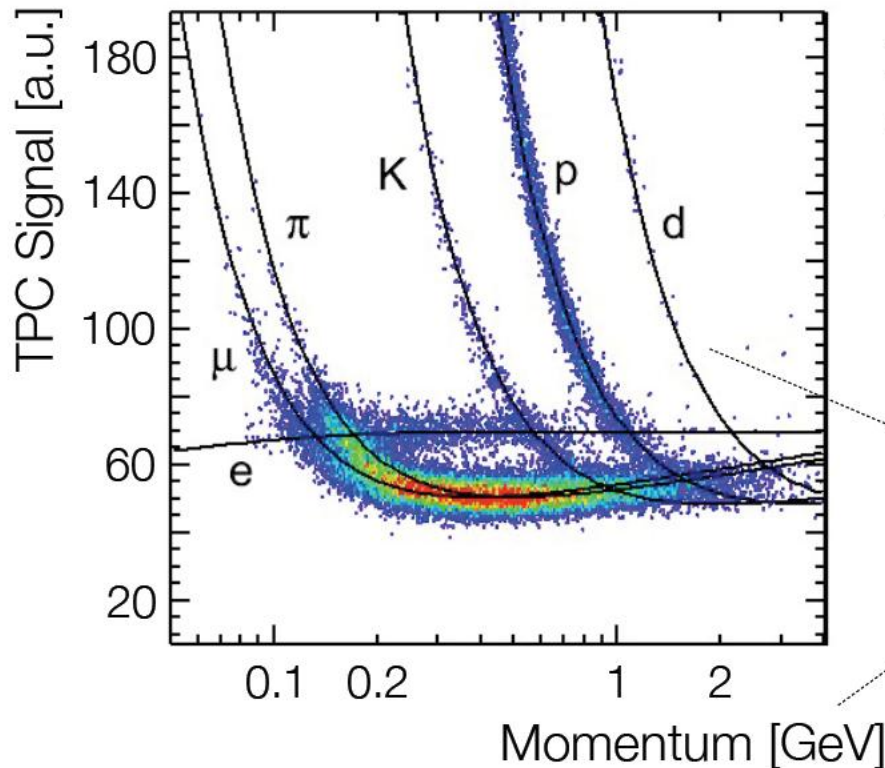

Measured energy loss
[ALICE TPC, 2009]

Bethe-Bloch

Remember:
 dE/dx depends on β !

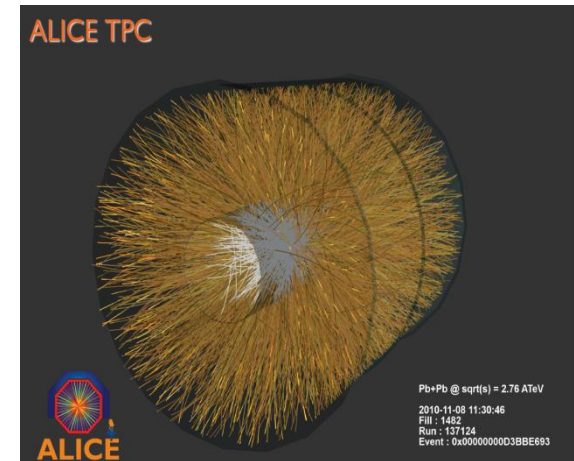

Energy loss can be used for particles identification.

Energy loss of electrons

Bethe-Bloch formula needs modification

Incident and target electron have same mass m_e
Scattering of identical, undistinguishable particles

$$-\left\langle \frac{dE}{dx} \right\rangle_{\text{el.}} = K \frac{Z}{A} \frac{1}{\beta^2} \left[\ln \frac{m_e \beta^2 c^2 \gamma^2 T}{2I^2} + F(\gamma) \right]$$

[T: kinetic energy of electron]

Bremsstrahlung arises if particles
are accelerated in Coulomb field of nucleus

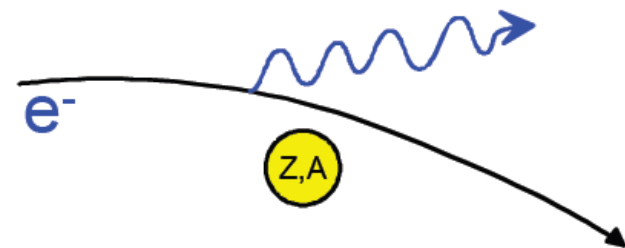

$$\frac{dE}{dx} = 4\alpha N_A \frac{z^2 Z^2}{A} \left(\frac{1}{4\pi\epsilon_0} \frac{e^2}{mc^2} \right)^2 E \ln \frac{183}{Z^{1/3}} \propto \frac{E}{m^2}$$

i.e. energy loss proportional to $1/m^2$ → main relevance for electrons ...

... or ultra-relativistic muons

Total energy loss of electrons

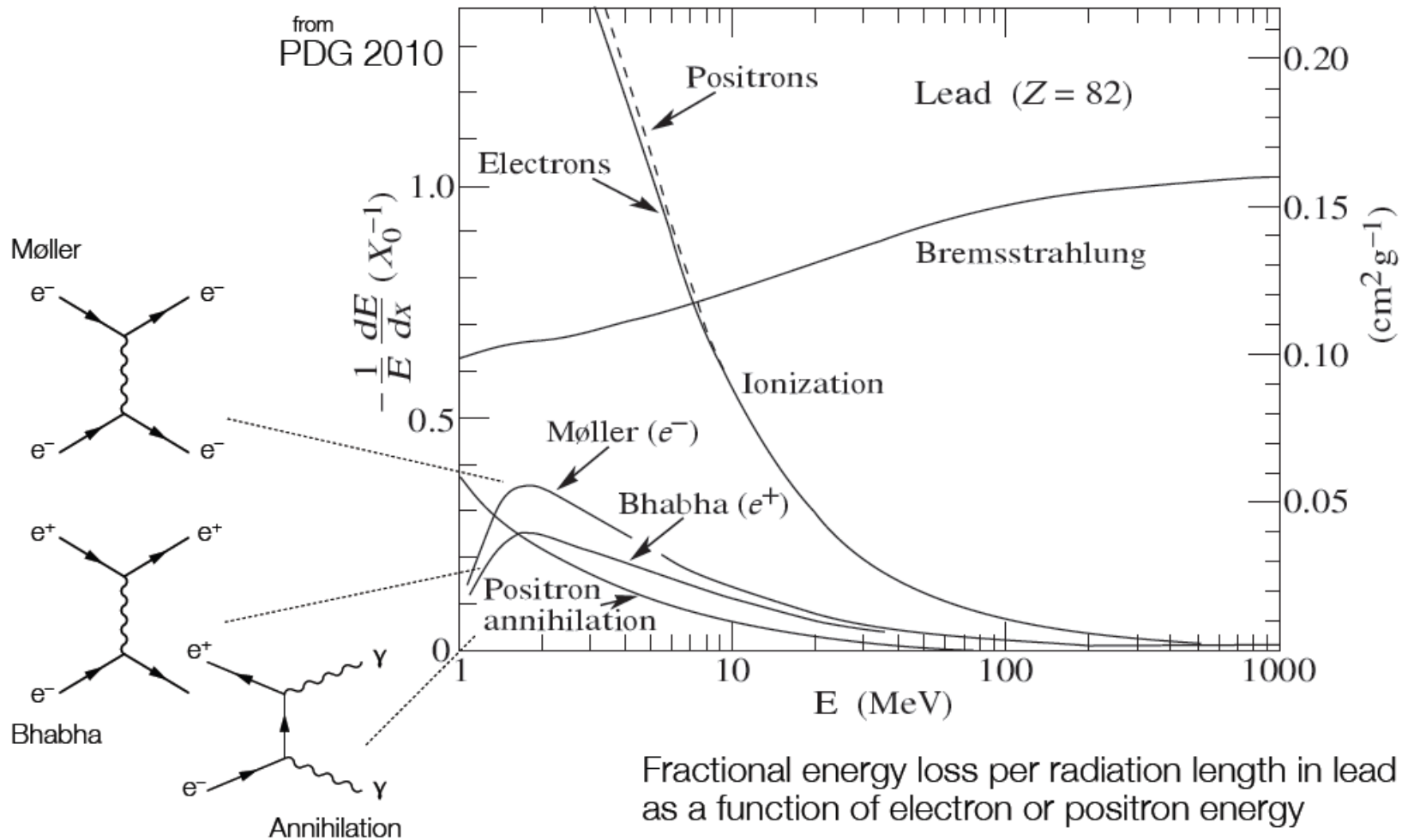

ATLAS Inner Detector

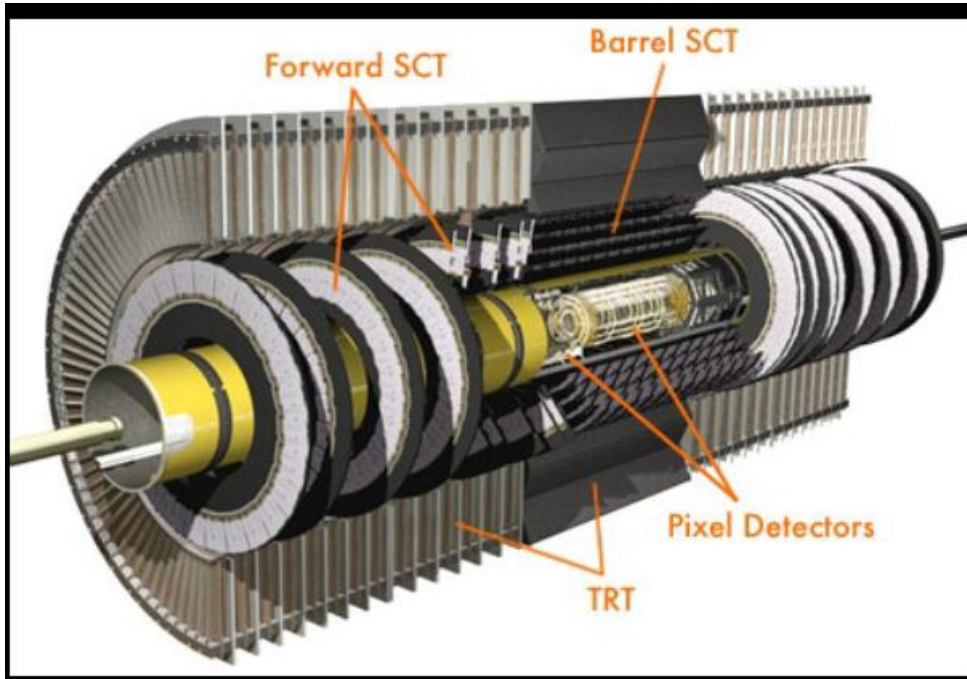

- 3 layers of pixel modules in barrel
- 2x5 disks of forward pixel disks
- 4 layers of strip (SCT) modules in barrel
- 2x9 disks of forward strip modules

Figure : ATLAS Inner detector (ID) in LHC run 1 with pixel and strip (SCT) silicon and transition radiation (TRT) detectors. The length is about 5.5 m.

Transition Radiation Tracker

Combine tracking with particle identification (PID)

- Charged particles radiate photons when crossing material borders.
- e^\pm radiate more x-rays than heavier particles.
- Use this particle PID, i.e. distinguish e^\pm from hadrons.
- ATLAS has a TR detection in the inner detector. It uses gas for detection.

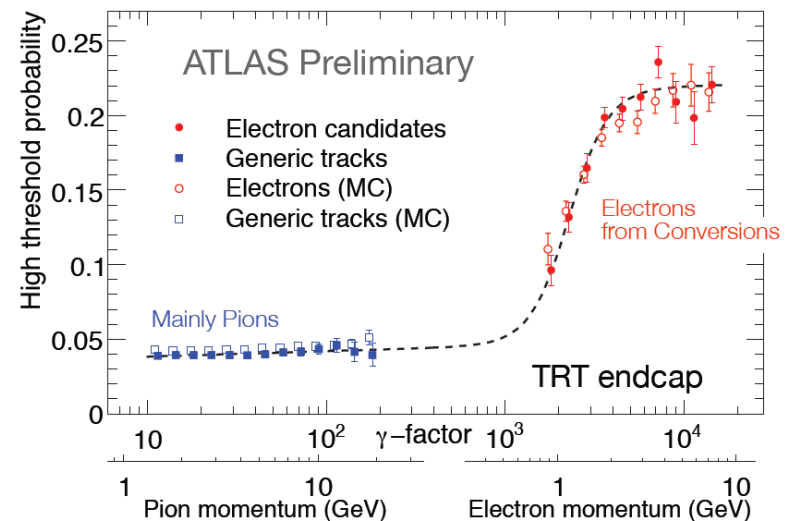
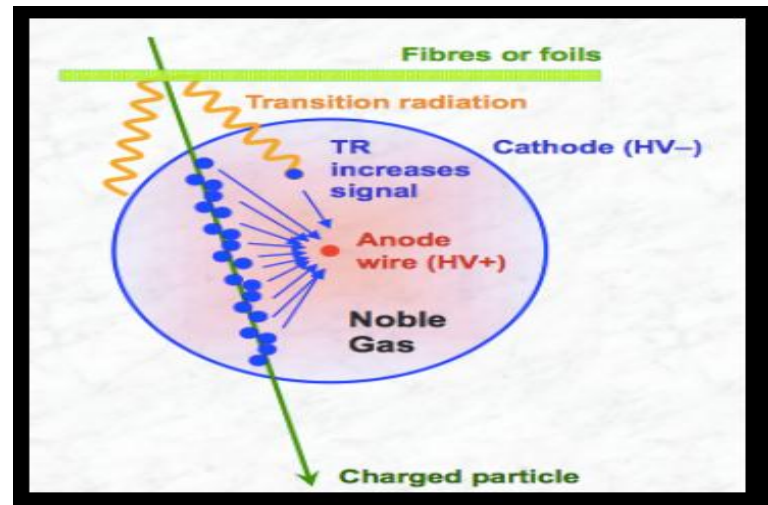

$\gamma \rightarrow e^+e^-$ conversions

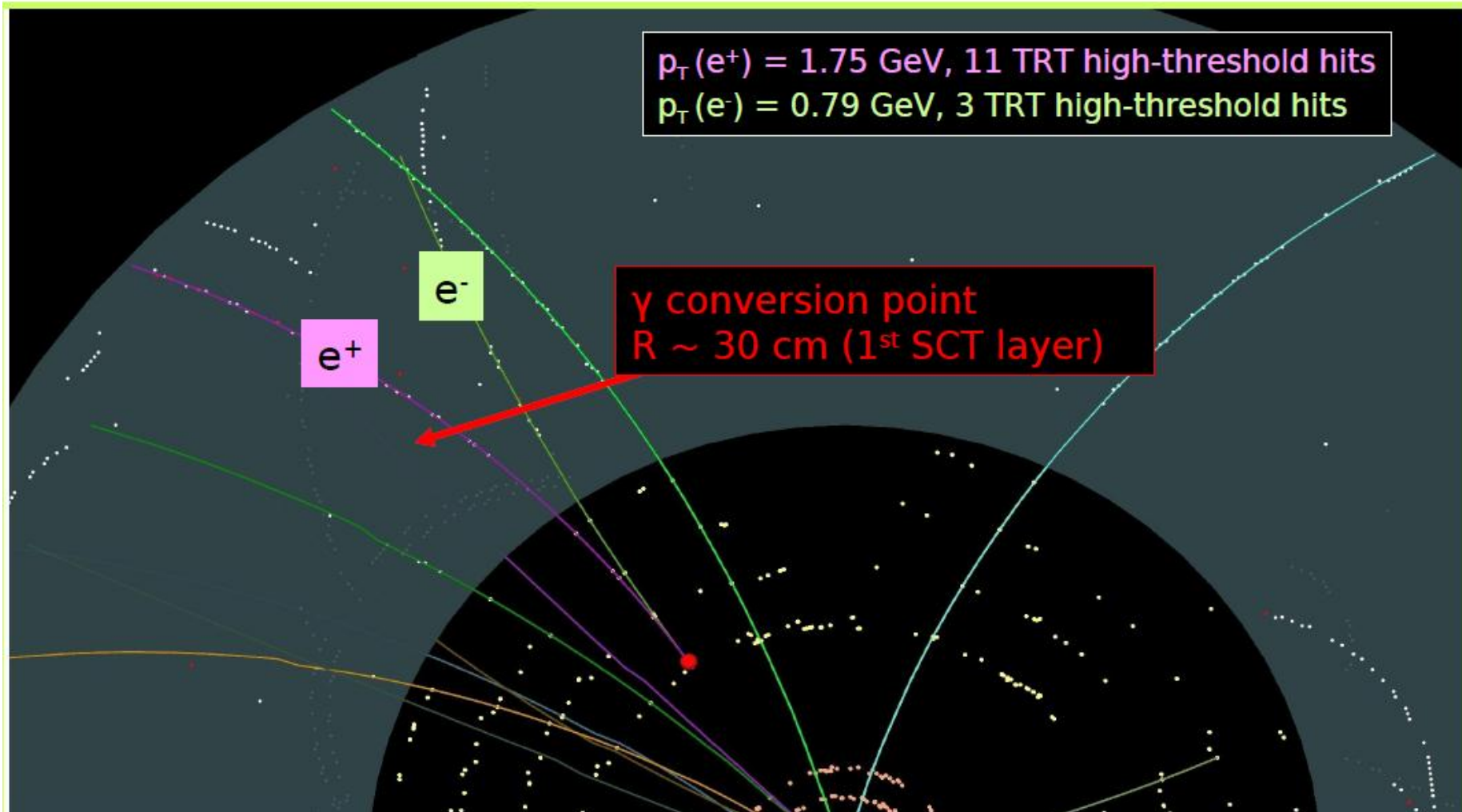

How do we “see” particles?

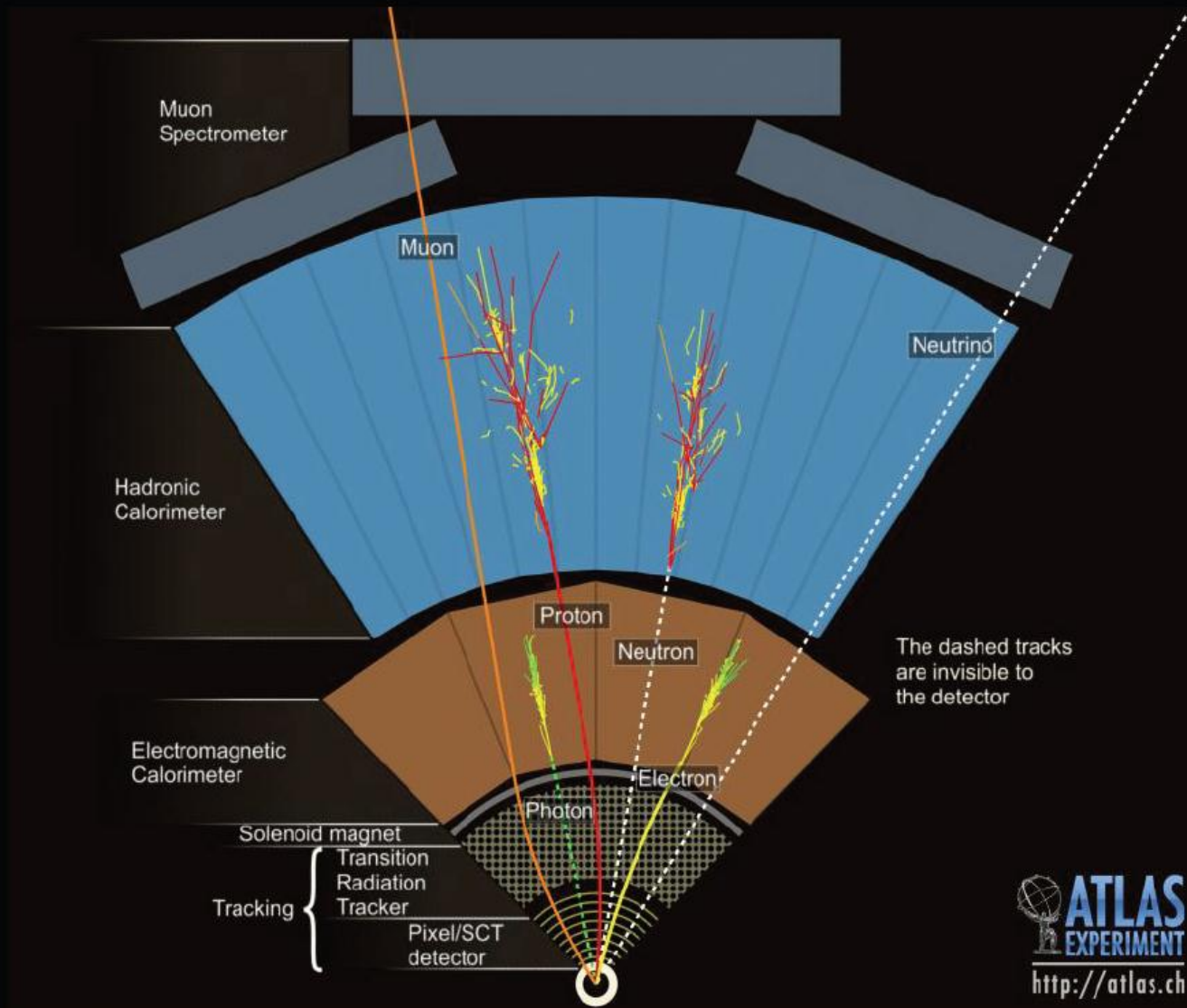

Muon detection in tracking detector

Muon has electrical charge, $m_\mu \sim 106 \text{ MeV} \sim 200m_e$, no strong charge, life time $\tau = 2.2 \mu\text{s}$; at LHC interesting range $p_\mu \sim 5 \dots 1000 \text{ GeV}$.

- **Curves in magnetic field (charge and momentum)**
- **Makes track in inner detector/silicon**
- **Penetrates the full detector, „stable“ wrt detector size**
- **Energy loss described by Bethe-Bloch formulae**

Assume (curved) tracks outside the calorimeters to be muons. That means:

- **Large detectors, i.e. usually gas**
- **Match with tracks from inner detector**
 - **Negligible processes:**
 - $\sigma_{\text{Brems}} \sim E/m^2$ for low E
 - **Multiple scattering $m_\mu \gg m_e$**
- **Watch out for non muon punch through from calorimeter**

Triggering muons

- Design LHC bunch spacing is 25ns, i.e. need for fast detectors:
 - Resistive Plate Chambers (RPC)
 - Thin Gap Chambers (TGC)
 - Large surface chambers with thin (mm) gas layers for fast detection (ps to ns)

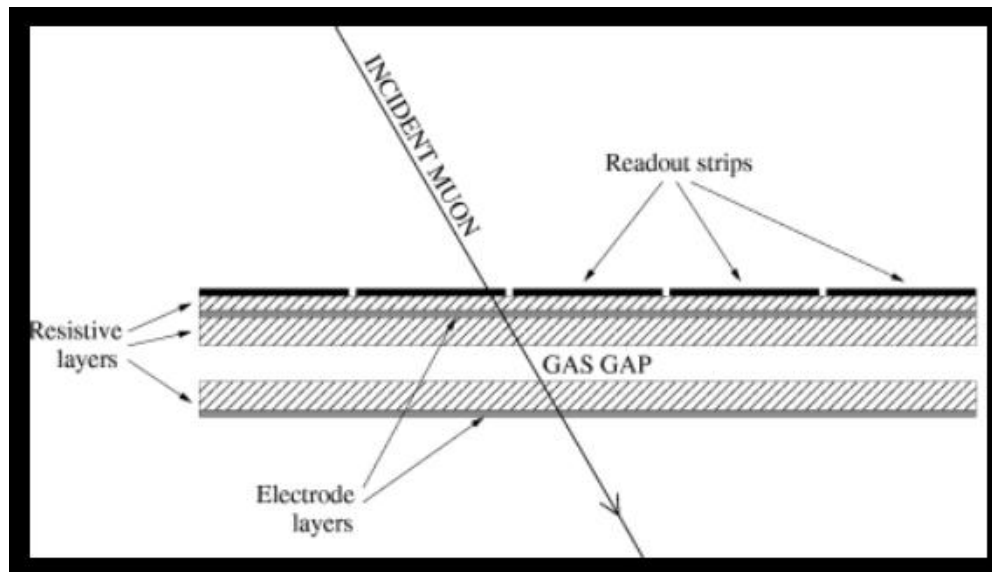

2 mm gap in ATLAS

Measuring muons

For high precision position measurements:

- Drift tubes with gas, position drift time (ATLAS, CMS)
 - Array of 10^{4-5} tubes, 1-10cm², up to 10m long
 - 50-100 mm and ns resolution
 - Deadtime 20-100 ns
- Cathode Strip Chambers (ATLAS, CMS, LHCb)
 - Multiwire gas chamber with strip read-out
- Micro Pattern Gas Detector (LHCb)
- Time Projection Chamber (ALICE)

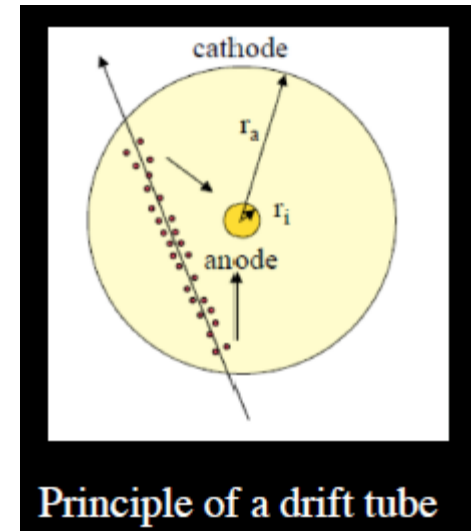
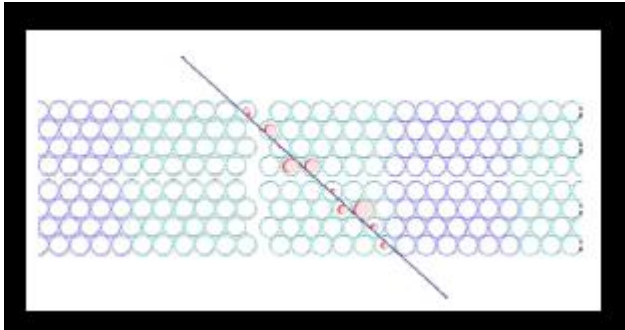

Principle of a drift tube



A module with 2x4 layers of drift tubes (ATLAS)

Muon system in ATLAS

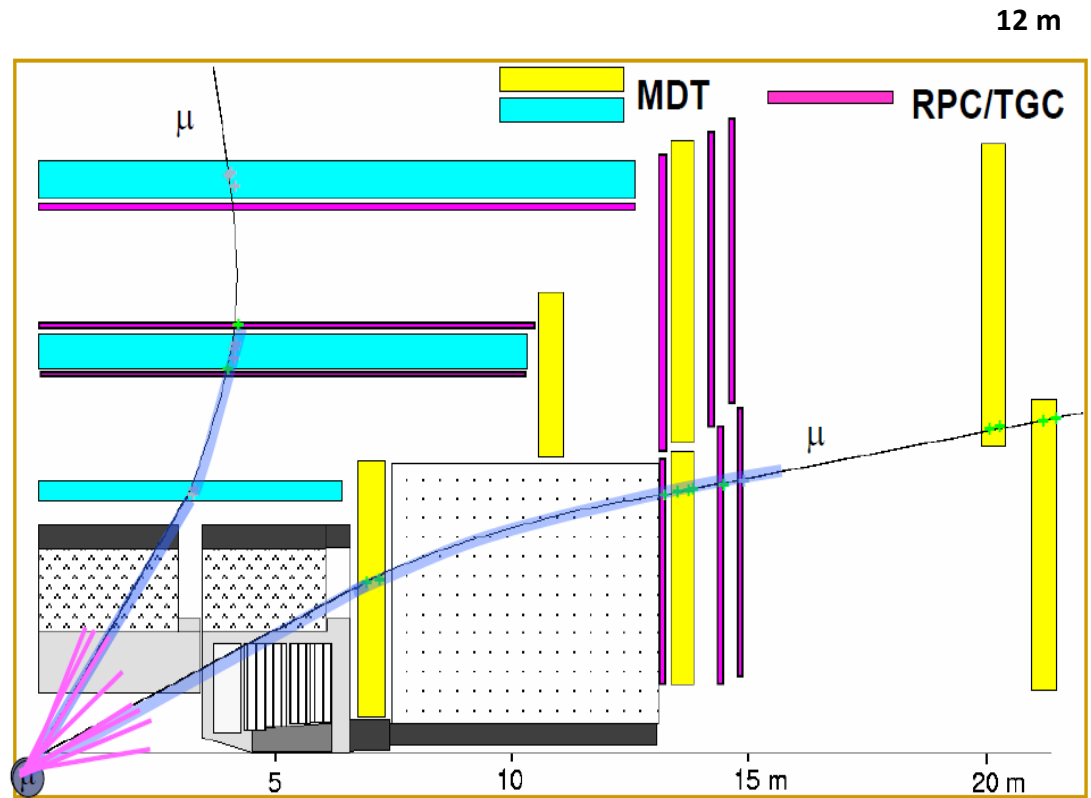

How do we “see” particles?

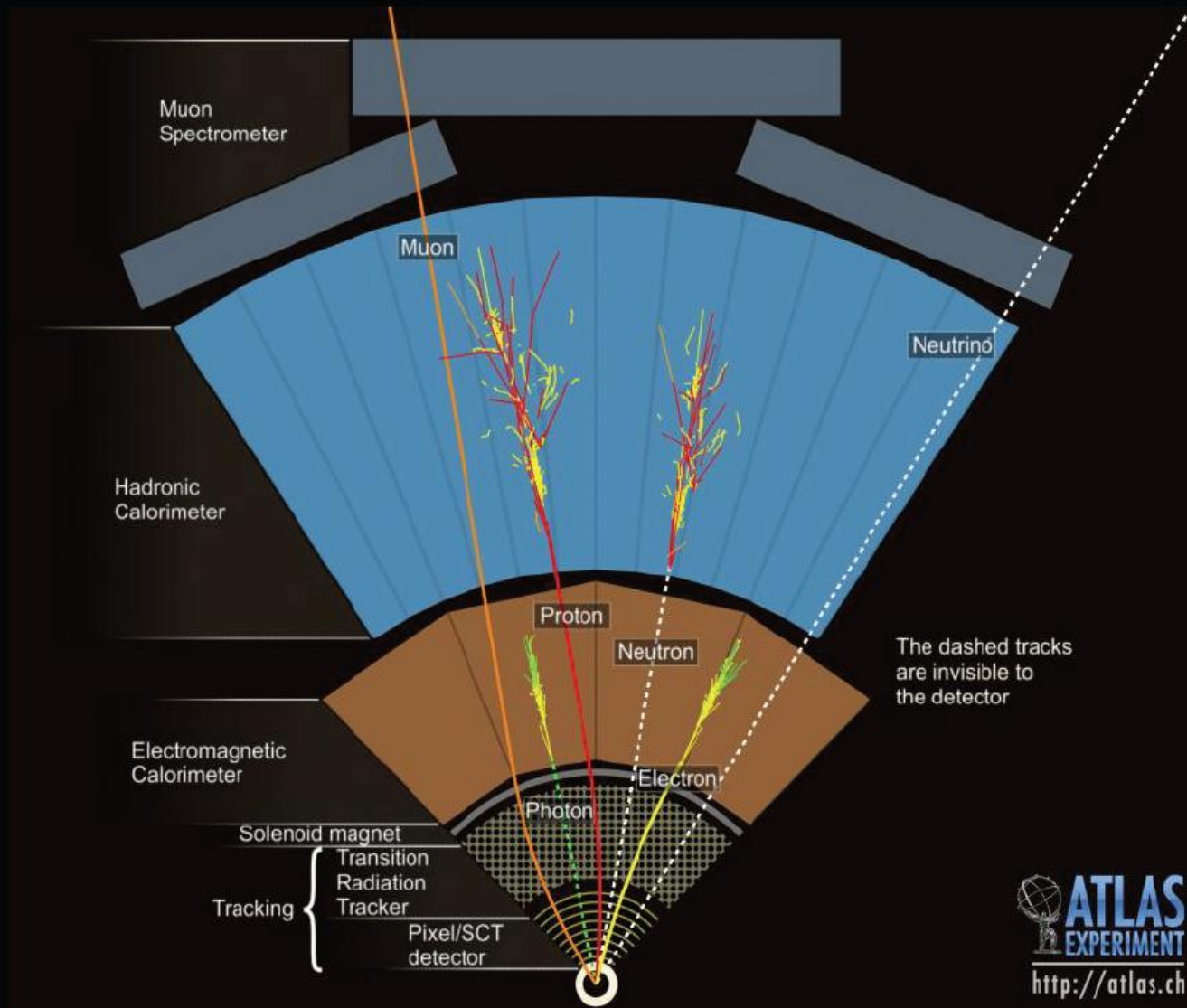

Calorimeter: principle of the measurement?

- **Energy measurement via total absorption of particles**

- **Principles of operation**

- ✓ Incoming particle initiates particle shower

- Electromagnetic, hadronic
- Shower properties depend on particle type and detector material

- ✓ Energy is deposited in active regions

- Heat, ionization, atom excitation (scintillation), Cherenkov light
- Different calorimeters use different kind of signals

- ✓ Signal is proportional to energy released

- Proportionally → calibration
- Shower containment

incident particle

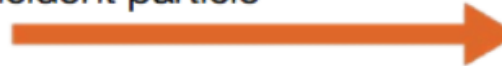

particle cascade (shower)

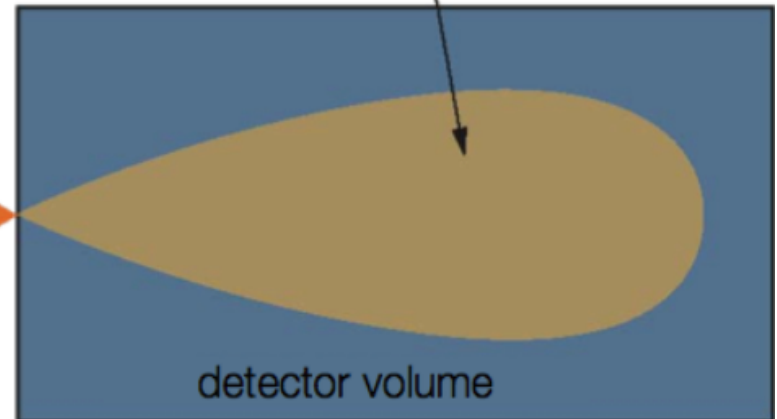

1 calorie (4.185J) is the necessary energy to increase the temperature of 1 g of water at 15°C by one degree

At hadron colliders we measure GeV (0.1 - 1000)

1 GeV = 10^9 eV $\approx 10^9 \cdot 10^{-19}$ J = 10^{-10} J = $2.4 \cdot 10^{-9}$ cal

1 TeV = 1000 GeV : kinetic energy of a flying mosquito

Why calorimeters?

First calorimeters appeared in the 70's:
need to measure the energy of all
particles, **charged** and **neutral**.

Until then, only the momentum of
charged particles was measured using
magnetic analysis.

The measurement with a calorimeter is
destructive e.g.

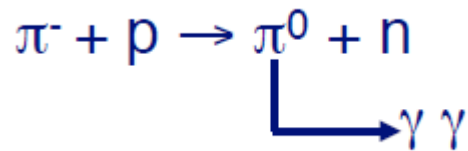

Magnetic
analysis

$$\frac{\sigma(p)}{p} = ap \oplus b$$

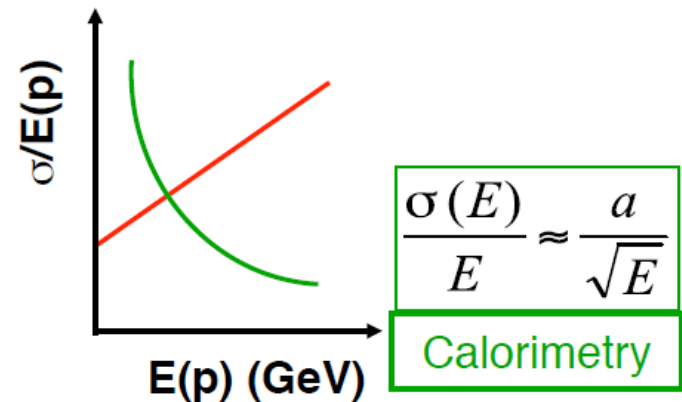

Particles do not come out alive of a calorimeter

EM and hadron calorimeters

- Calorimeters are subdivided into **electromagnetic** and **hadronic** sub-detectors
- Electromagnetic interactions develop over shorter distances than hadronic interactions
- Fundamental processes of signal generation differ, calling on different optimization

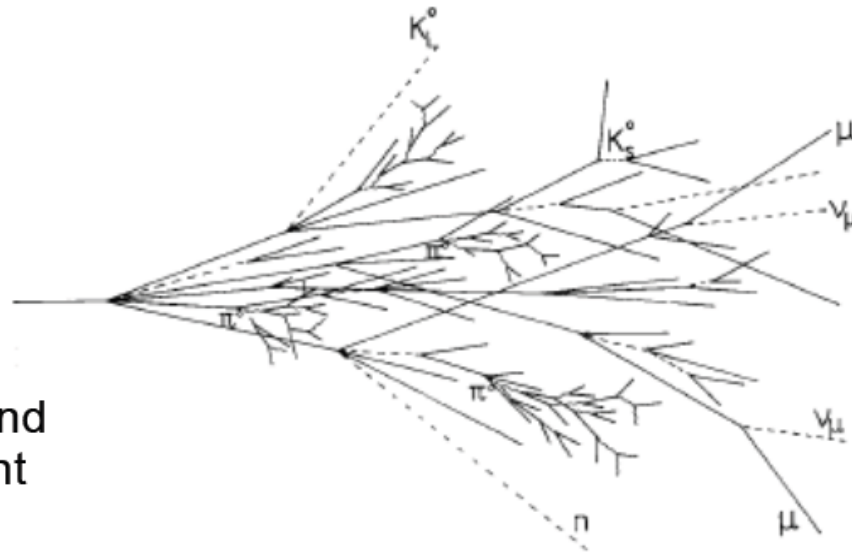

cascade with EM and
hadronic component

A typical HEP calorimetry system

Typical Calorimeter: two components ...

Electromagnetic (EM) +
Hadronic section (Had) ...

Different setups chosen for
optimal energy resolution ...

Schematic of a
typical HEP calorimeter

Electrons
Photons

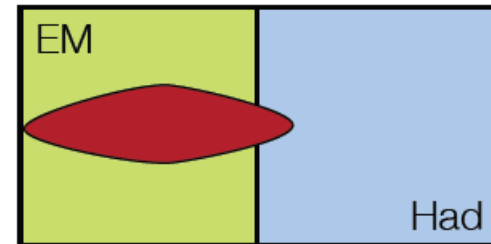

Taus
Hadrons

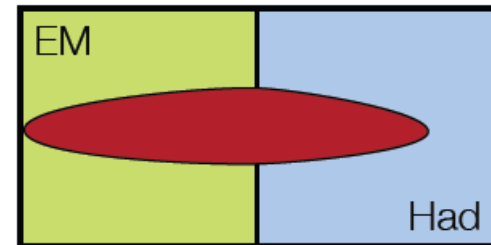

But:

Hadronic energy measured in
both parts of calorimeter ...

Needs careful consideration of
different response ...

Jets

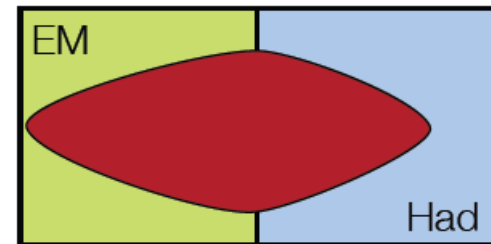

Electromagnetic showers

At high energies, electromagnetic showers result from electrons and photons undergoing mainly **bremsstrahlung** and **pair creation**.

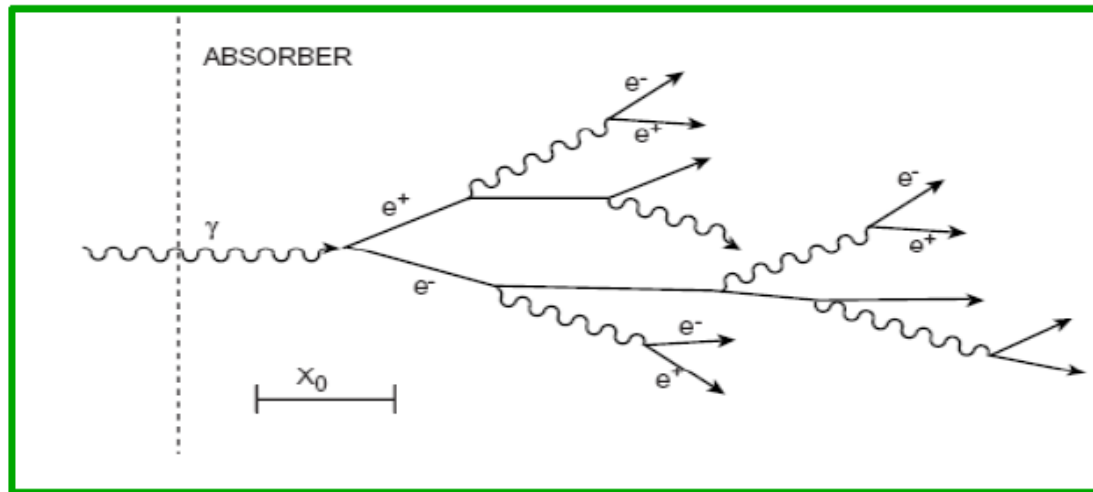

For high energy (GeV scale) **electrons** **bremsstrahlung** is the dominant energy loss mechanism.

For high energy **photons** **pair creation** is the dominant absorption mechanism.

Shower development is governed by these processes.

Radiation length

The radiation length is a “universal” distance, very useful to describe electromagnetic showers (electrons & photons)

X_0 is the distance after which the incident electron has radiated $(1-1/e)$ 63% of its incident energy

$$\begin{aligned} dE/dx &= E/X_0 \\ dE/E &= dx/X_0 \\ E &= E_0 e^{-x/X_0} \end{aligned}$$

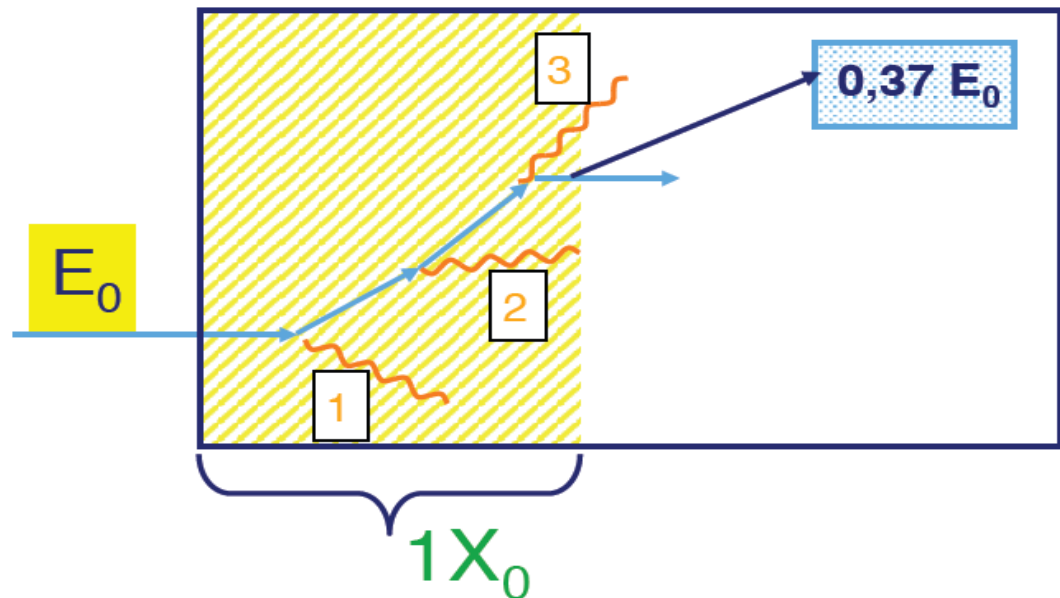

	Air	Eau	Al	LAr	Fe	Pb	PbWO ₄
Z	-	-	13	18	26	82	-
X_0 (cm)	30420	36	8,9	14	1,76	0.56	0.89

Total energy loss of electrons

Electrons mainly lose their energy via ionization & Bremsstrahlung

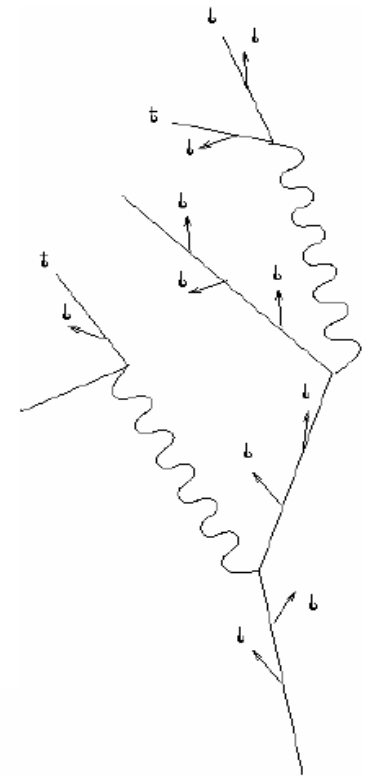
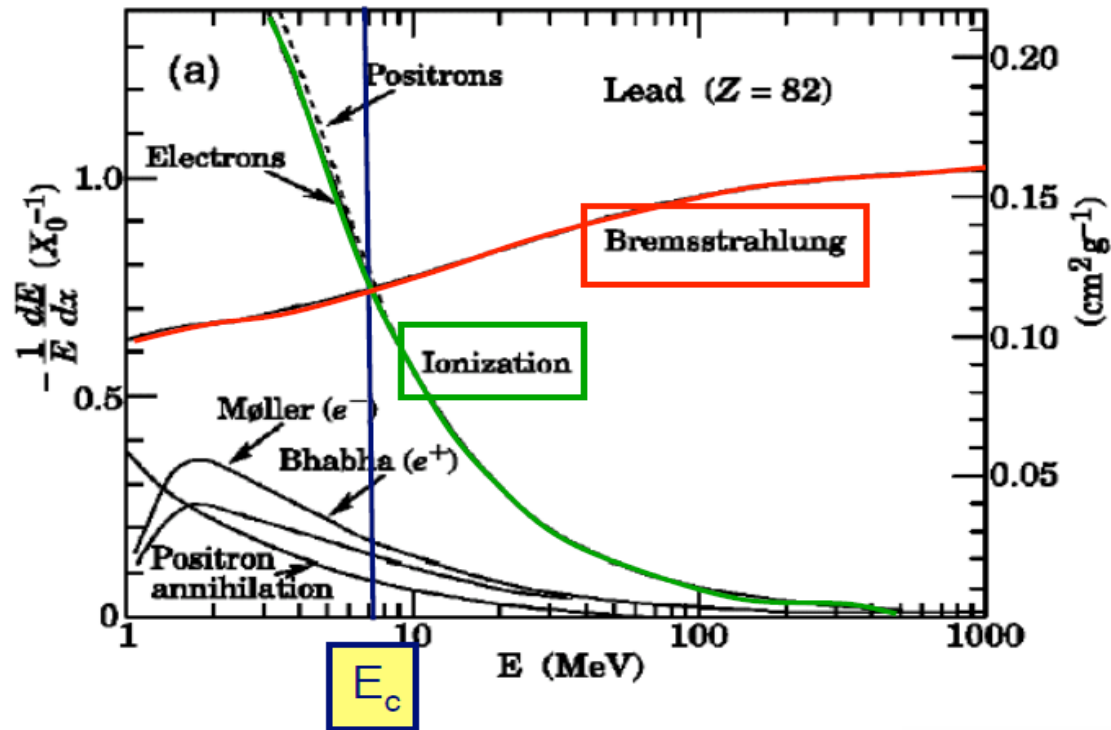

Total energy loss for photons

Pair Production

$$\sigma_{pair} \approx \frac{7}{9} \times \frac{A}{N_A} \times \frac{1}{X_0}$$

Probability of conversion in 1 X_0 is $e^{-7/9}$

Can define mean free path:

$$\lambda_{pair} \approx \frac{9}{7} X_0$$

Compton scattering

$$\sigma_C \approx \frac{\ln E_\gamma}{E_\gamma}$$

Photo-electric effect

$$\sigma_{pe} \approx Z^5 \alpha^4 \left(\frac{m_e c^2}{E_\gamma} \right)^{\frac{7}{2}}$$

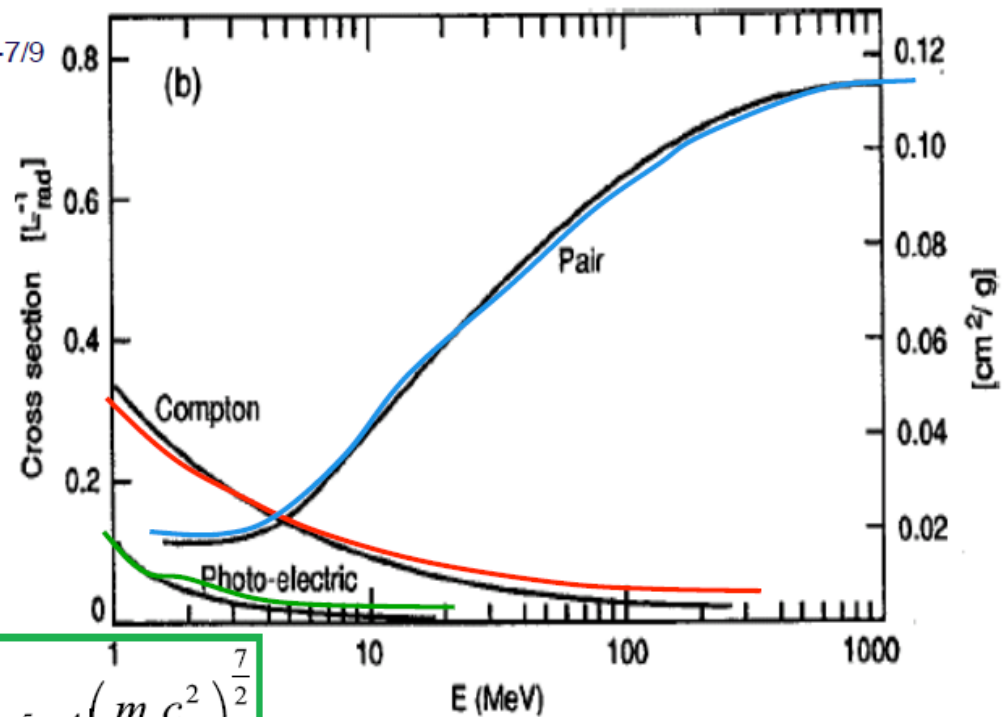

EM and hadron calorimeters

- “Lead-scintillator” calorimeter

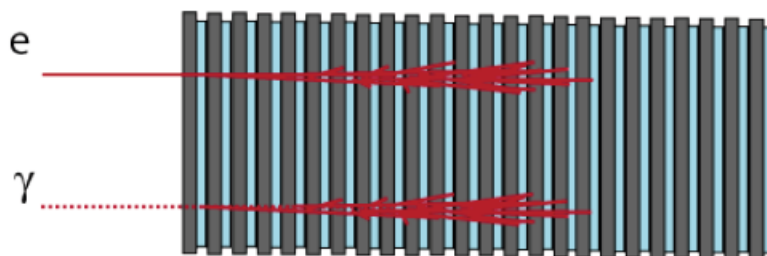

Energy resolutions:

$$\Delta E/E \sim 20\%/\sqrt{E}$$

- Exotic crystals (BGO, PbW, ..)



$$\Delta E/E \sim 1\%/\sqrt{E}$$

- Liquid argon calorimeter

– Slow collection time ($\sim 1\mu\text{sec}$)

$$\Delta E/E \sim 18\%/\sqrt{E}$$

Sampling calorimeters

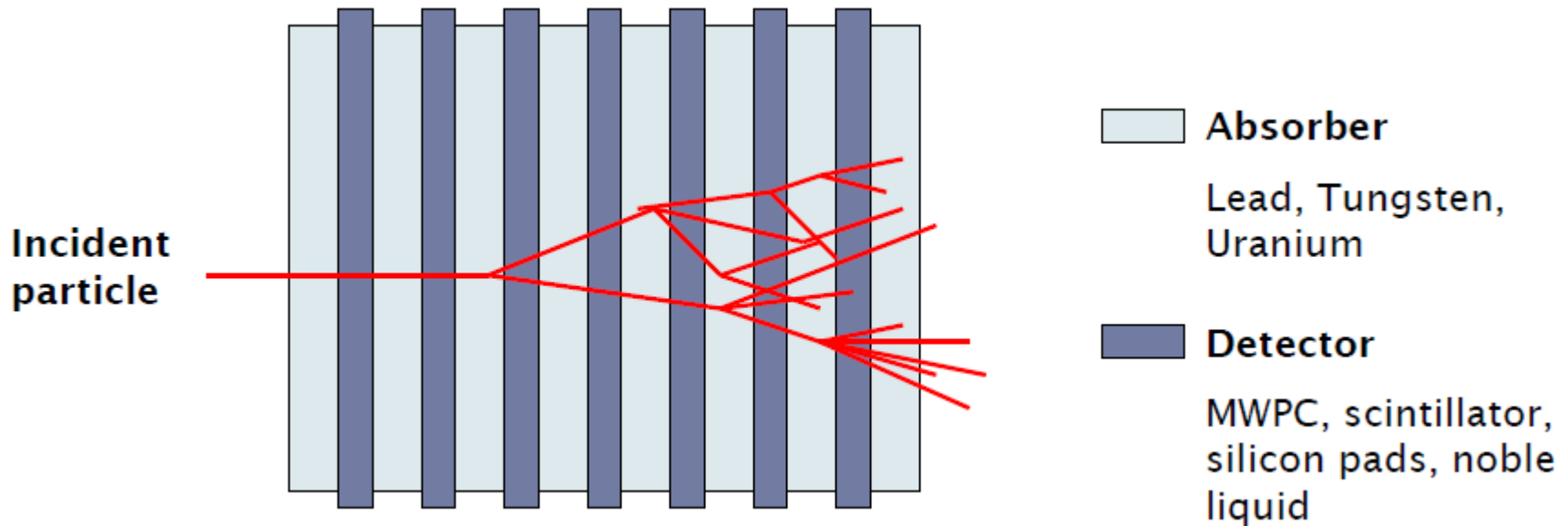

- **Absorber (passive) and detector (active) layers**
- **Fluctuations in visible energy: „sampling fluctuations” due to variations of number of charged particles in the detector**

Energy resolution

- **Statistical fluctuations**
 - In the number of particles in the shower
 - In the number of escaping or undetected particles
- **Noise**
 - Electronic noise
 - Pile up
- **Constant**
 - Dead material
 - Calibration errors
 - Mechanical imperfections
- **Higher energy -> better resolution**

$$\frac{\sigma(E)}{E} = \frac{a}{\sqrt{E}} \oplus \frac{\sigma_n}{E} \oplus \text{constant}$$

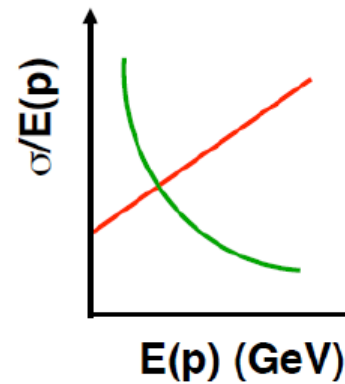

Magnetic
analysis

$$\frac{\sigma(p)}{p} = ap \oplus b$$

$$\frac{\sigma(E)}{E} \approx \frac{a}{\sqrt{E}}$$

Calorimetry

Linearity

Response: mean signal per unit of deposited energy
e.g. # of photons electrons/GeV, pC/MeV, $\mu\text{A}/\text{GeV}$

→ A linear calorimeter has a constant response

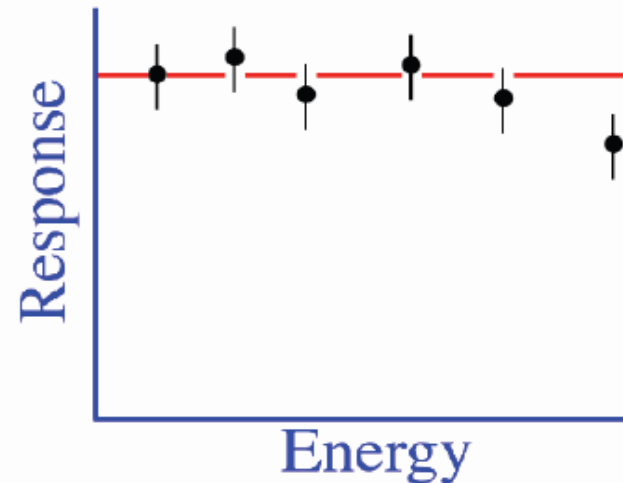
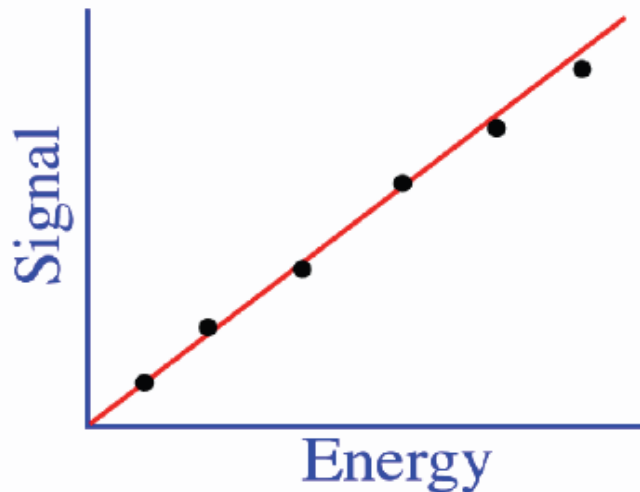

Electromagnetic calorimeters are in general linear.
All energies are deposited via ionisation/excitation of the absorber.

Position and time resolution

Higgs Boson in ATLAS

For $M_H \sim 120$ GeV, in the channel $H \rightarrow \gamma\gamma$

$$\sigma(M_H) / M_H = \frac{1}{2} [\sigma(E_{\gamma 1})/E_{\gamma 1} \oplus \sigma(E_{\gamma 2})/E_{\gamma 2} \oplus \cot(\theta/2) \sigma(\theta)]$$

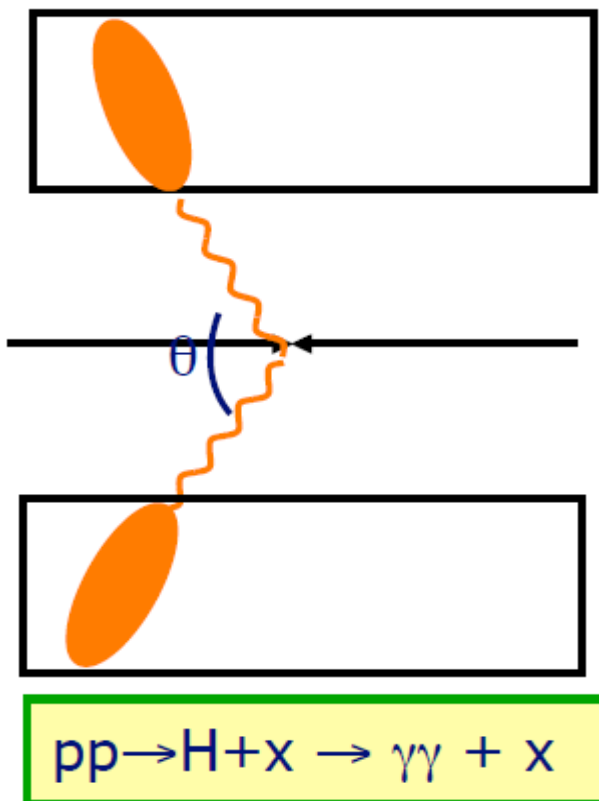

Time measurement

Validate the synchronisation between sub-detectors (~ 1 ns)

Reject non-collisions background (beam, cosmic muons,...)

Identify particles which reach the detector with a non nominal time of flight (~ 5 ns measured with ~ 100 ps precision)

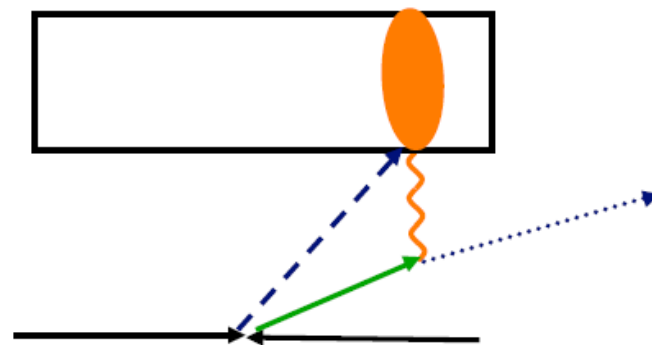

Particle identification

Particle Identification is particularly crucial at Hadron Colliders:

Large hadron background

Need to separate

Electrons, photons, muons from
Jets, hadrons

Means

Shower shapes (lateral & longitudinal segmentations)

Track association with energy deposit in calorimeter

Signal time

γ/π^0 rejection

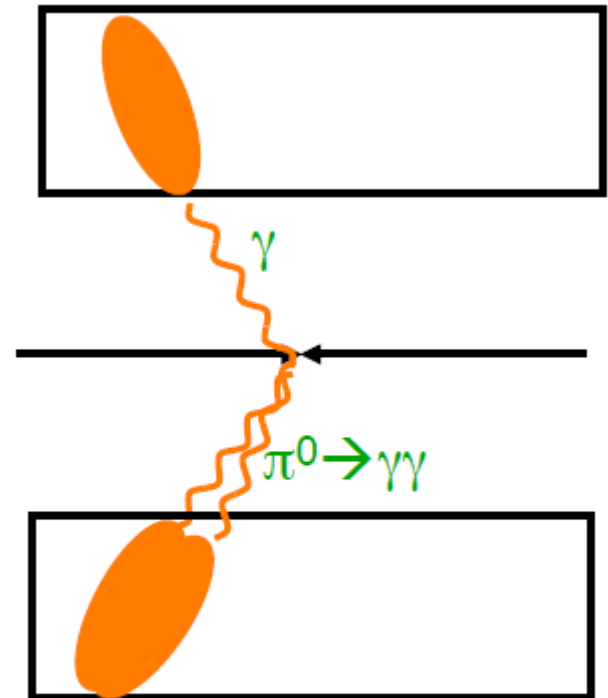

$pp \rightarrow \gamma\text{-jet} \rightarrow \gamma + \pi^0 + X$

ATLAS EM Calorimeter

Accordion Pb/LAr $|\eta| < 3.2$ ~170k channels

Precision measurement $|\eta| < 2.5$

3 layers up to $|\eta|=2.5$ + presampler $|\eta| < 1.8$

2 layers $2.5 < |\eta| < 3.2$

Layer 1 (γ/π^0 rej. + angular meas.)

$\Delta\eta, \Delta\phi = 0.003 \times 0.1$

Layer 2 (shower max)

$\Delta\eta, \Delta\phi = 0.025 \times 0.025$

Layer 3 (Hadronic leakage)

$\Delta\eta, \Delta\phi = 0.05 \times 0.025$

Energy Resolution: design for $\eta \sim 0$

$\Delta E/E \sim 10\%/\sqrt{E} \oplus 150 \text{ MeV}/E \oplus 0.7\%$

Angular Resolution

$50 \text{ mrad}/\sqrt{E(\text{GeV})}$

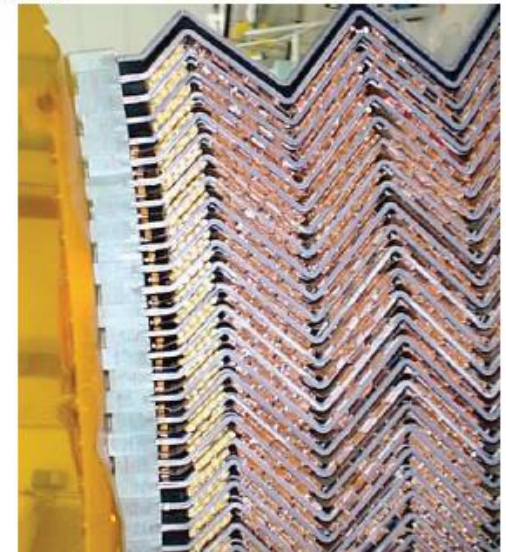
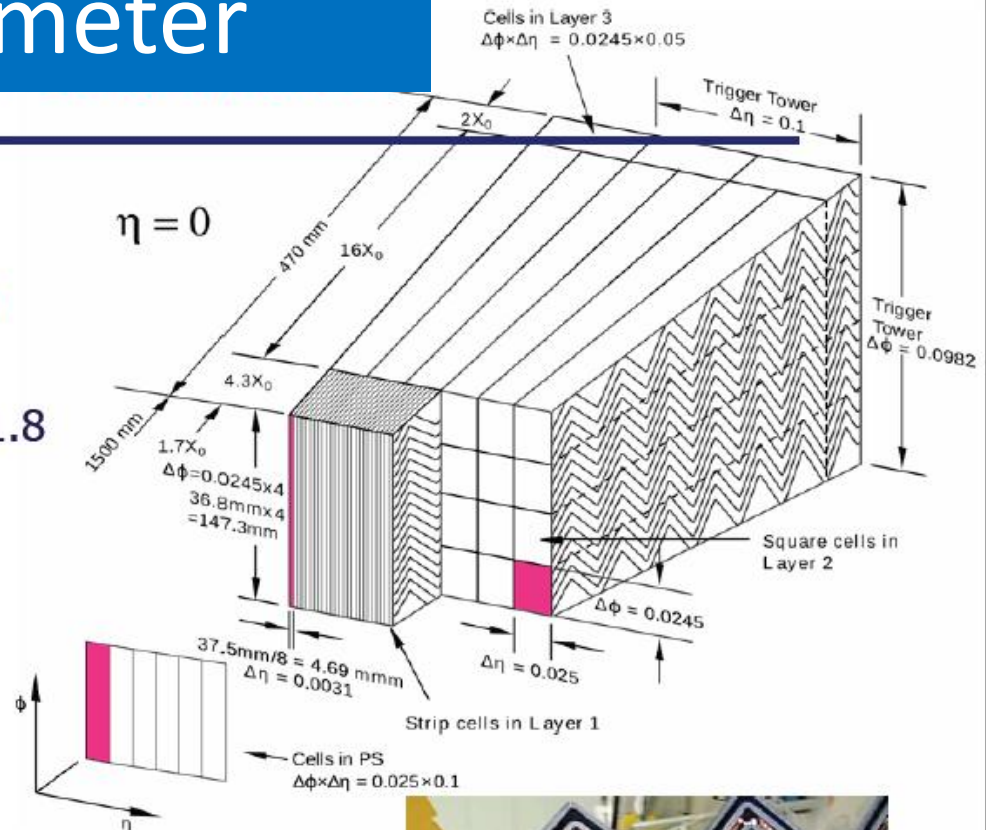

The segmentation

originæ27.dwg du 02/07/1999

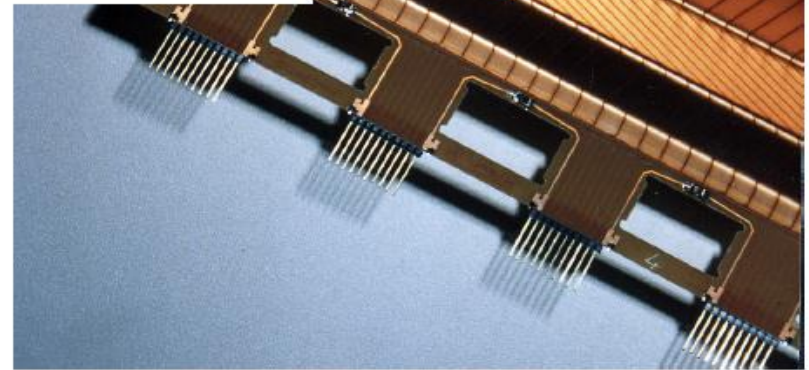
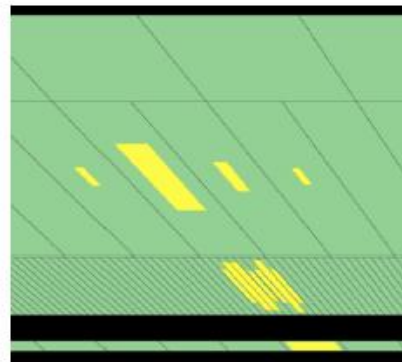
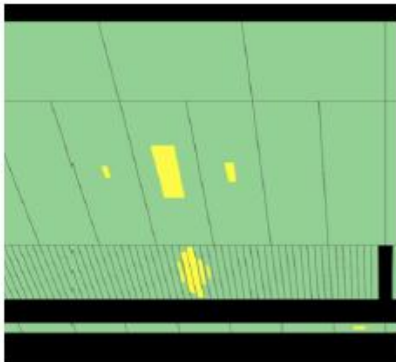
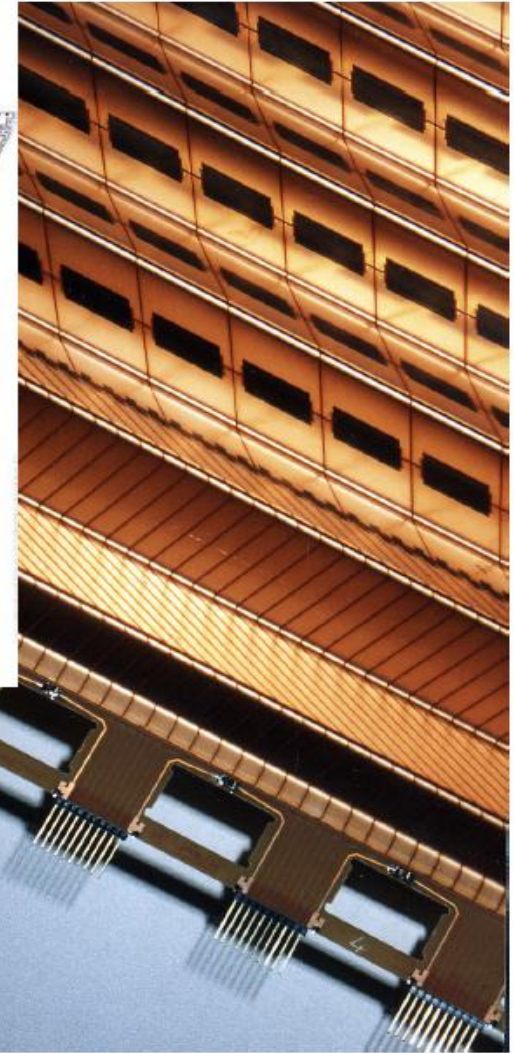
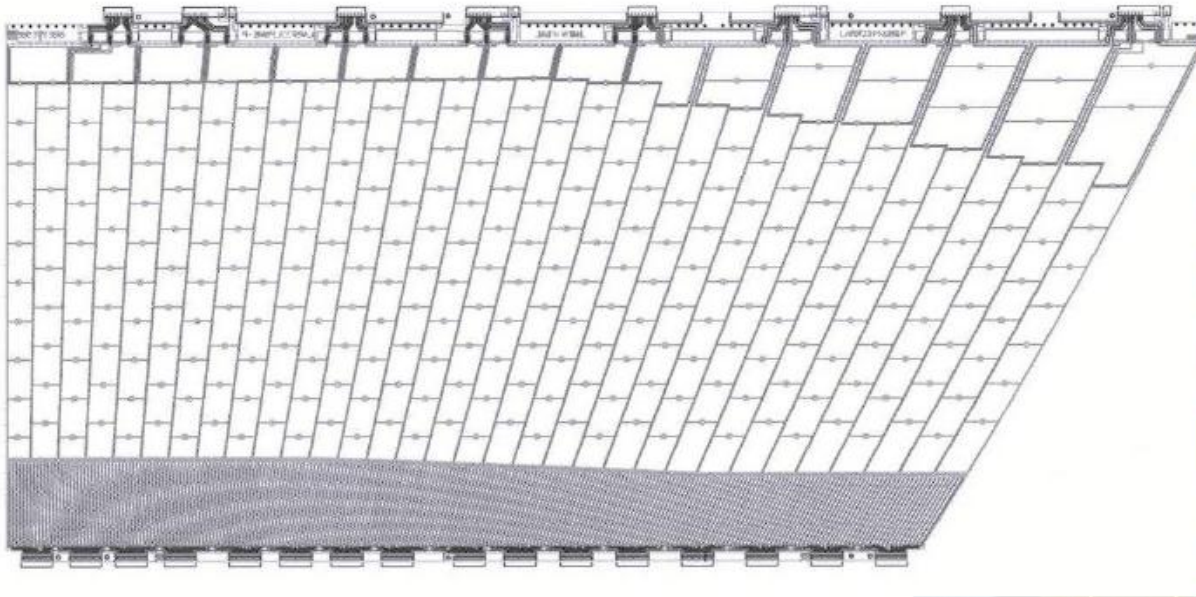

Particle identification with tracker and calo

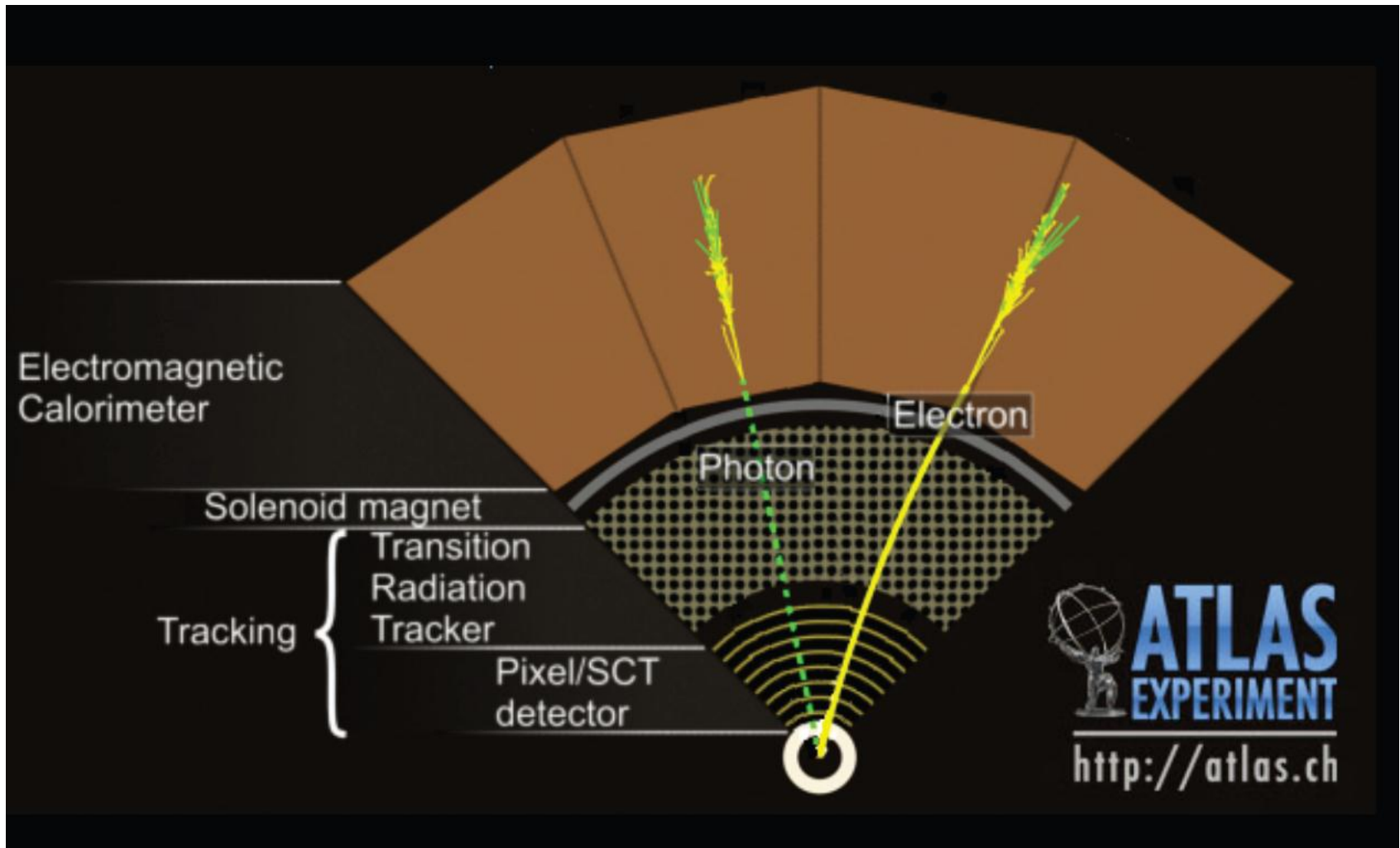

Position, momentum, energy

$$\frac{\sigma(E)}{E} = \frac{a}{\sqrt{E}} \oplus \frac{\sigma_n}{E} \oplus \text{constant}$$

Track



Position, Momentum

$$\frac{\Delta p}{p} \approx 0.25 \frac{\Delta s[\mu\text{m}]}{(L[\text{cm}])^2 B[\text{T}]} p[\text{GeV}]$$

$$\propto p$$

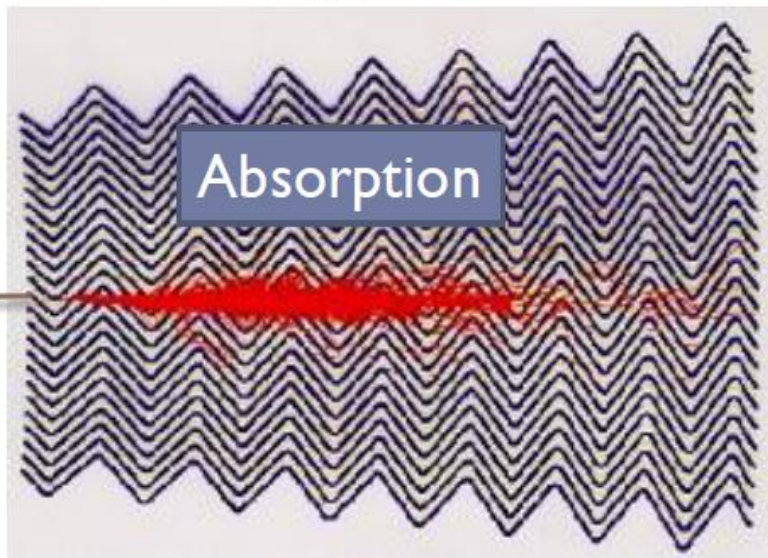

Energy

$$\propto \frac{1}{\sqrt{E}}$$

Cluster energy reconstruction

- E_{rec} : Need to correct E_{acc} for losses
 - in matter in front of calorimeter (IDI + cryostat)
 - Between Cryostat & Accordion
 - Loss outside the cluster $E_{outcluster}$
 - Rear leakage E_{leak}
- Use MC

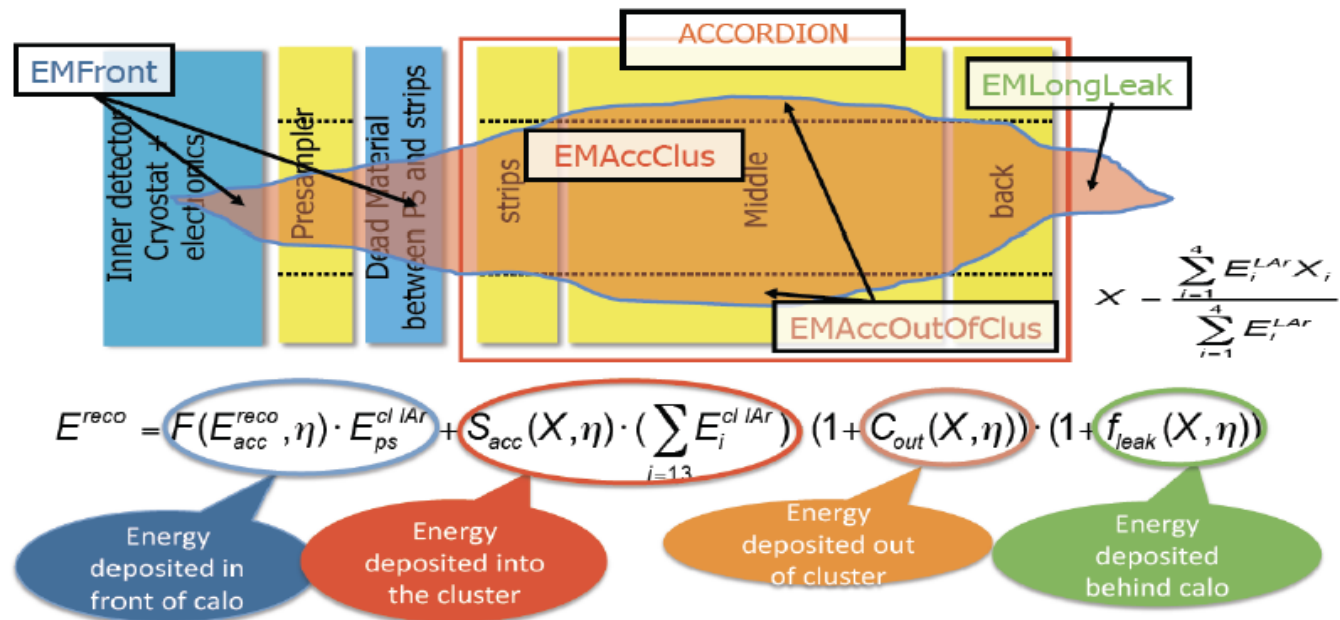
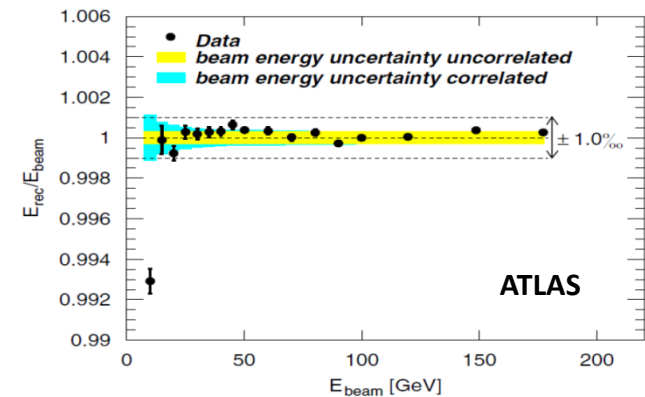

Hadron calorimetry

- Hadron Calorimeters, as EM calorimeters measure the **energy** of the incident particle(s) by fully absorbing the energy and providing measurement of absorbed energy
- Hadronic showers are more complicated than EM ones. The **longitudinal** development is characterised by the nuclear **interaction length** (mean free path before interaction)

EM shower

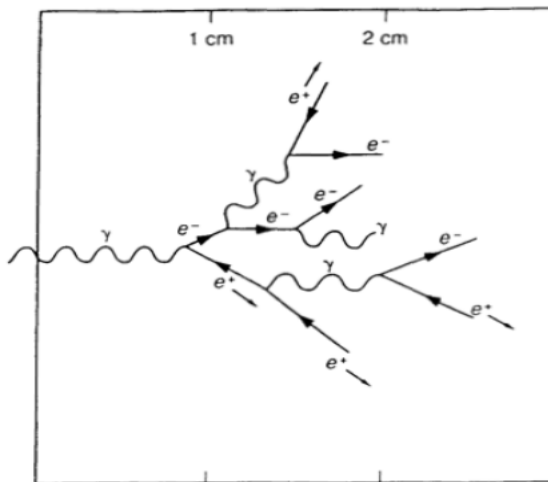

Hadronic shower

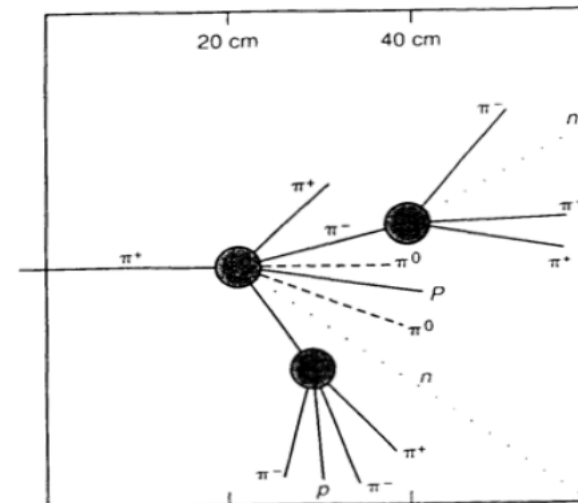

Hadronic showers

- **Nuclear interaction length: mean free path before interaction** $\lambda_{\text{int}} \approx 35 A^{1/3} \cdot \text{g} \cdot \text{cm}^{-2}$
- **Nuclear interaction length is longer than radiation length**

Material	Atomic No. (Z)	Radiation Length (X_0) (g/cm ²)	Radiation Length (X_0) (cm)	Interaction Length (λ) (g/cm ²)	Interaction Length (λ) (cm)	λ/X_0
Beryllium	4	65.19	35.28	75.2	40.7	1.2
Carbon	6	42.70	18.8	86.3	38.1	2.0
Aluminum	13	24.01	8.9	106.4	39.4	4.4
Iron	26	13.84	1.76	131.9	16.8	9.5
Copper	29	12.86	1.43	134.9	15.1	15.1
Tungsten	74	6.76	0.35	185.	9.6	27.4
Lead	82	6.37	0.56	194.	17.1	30.5
Uranium	92	6.00	0.32	199.	10.5	33.2

higher Z materials separate hadronic/EM interactions better

Hadronic showers

- Hadronic showers are
 - **Broader** and more penetrating
 - Subject to **large fluctuations**

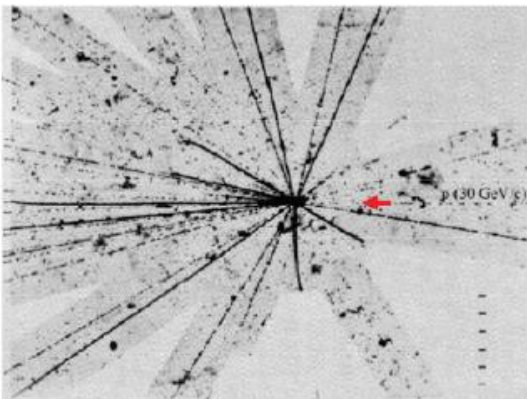
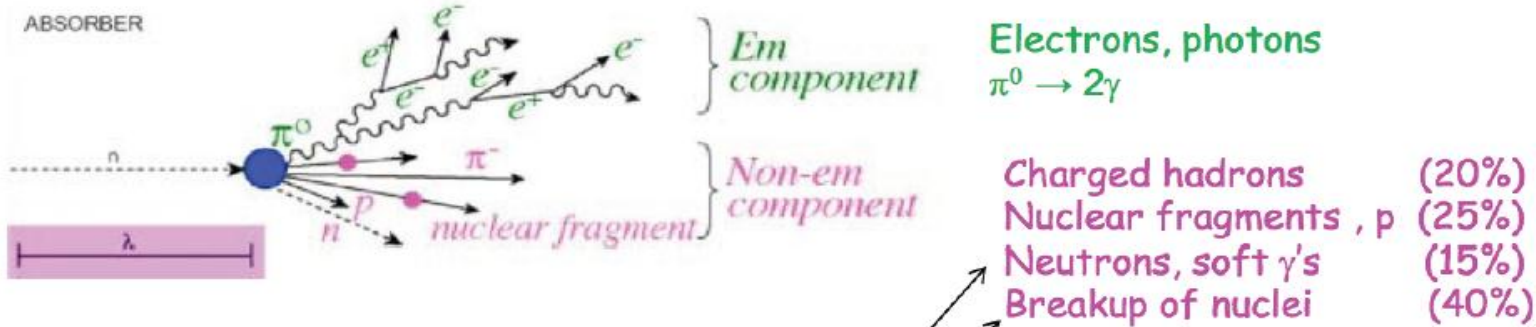

Either not detected
or often too slow to be
within detector time
window
= **Invisible energy**
 $e/h > 1$

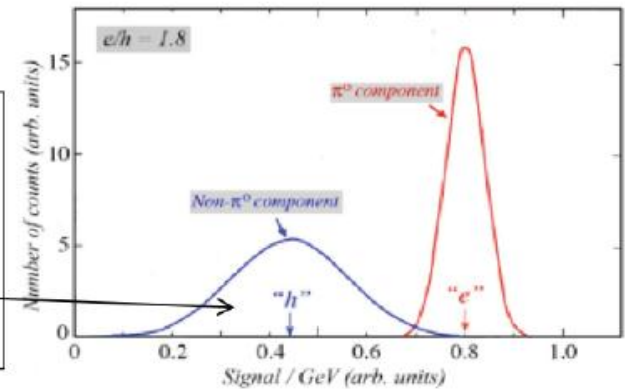

Hadronic showers: resolution

- fluctuations of en. measurement
 - the most important fluctuation: **binding energy (BE) losses**
 - correlated with EM shower energy fraction
- optimal resolution: need to **equalize** response of type A vs. type B

RANDOM EVENT

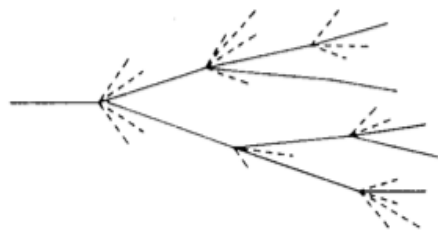

EXTREME EVENT: TYPE A

'small' BE loss
mostly EM energy

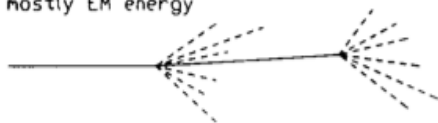

EXTREME EVENT: TYPE B

large BE loss
little EM energy

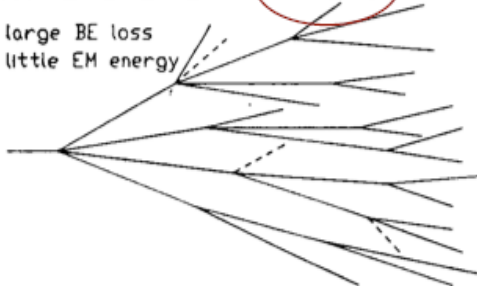

$e/h > 1$

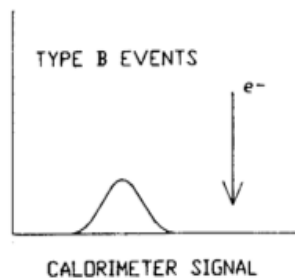
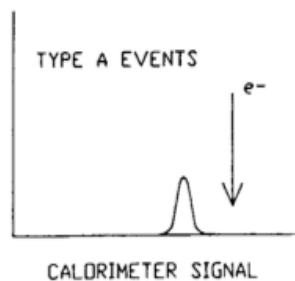
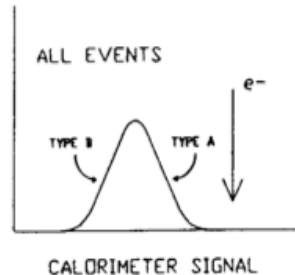

compensation:
 $e/h \sim 1$

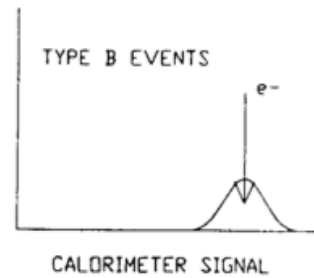
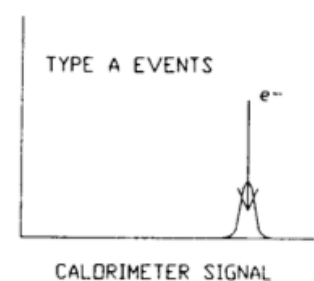
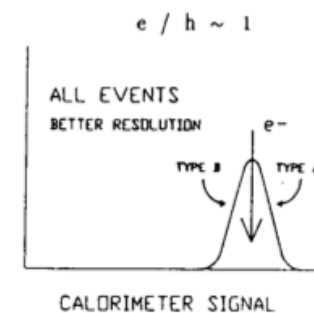

ATLAS Hadronic Calorimeter (Tile)

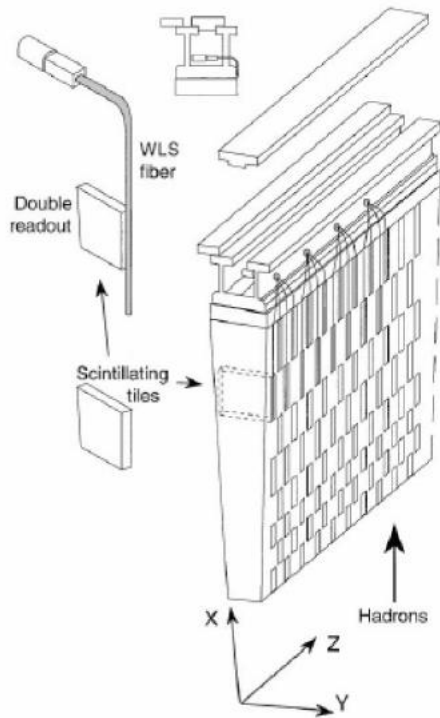

**Fe/Scint with WLS
fiber Readout via PMT**

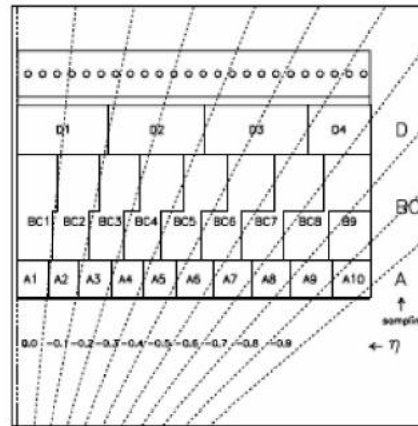

Figure 5-15 Cell geometry of half of a barrel module. The fibres of each cell are routed to one PMT.

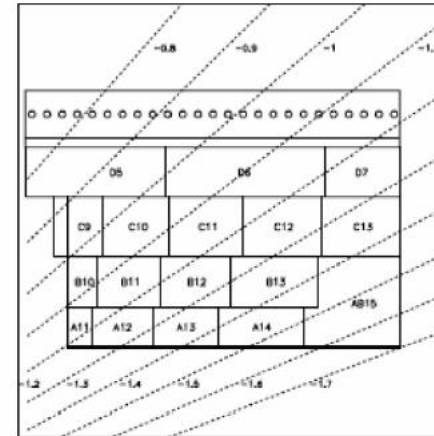

Figure 5-16 Proposed cell geometry for the extended barrel modules (version "a la barrel").

Hadronic and EM calorimeters

EM calorimeters

- Very well understood theoretically
- Technology continue to advance
- Have good energy resolution ($2-10\%/E^{1/2}$)
- EM showers develop through brems and pair production
- Characteristic length is radiation length X_0

Hadronic calorimeters

- Hadronic showers are more complex
- Hadronic calorimeters have worse energy resolution than EM ones ($40-100\%/E^{1/2}$)
- Hadronic showers develop through nuclear interaction
- Characteristic length is interaction length λ

Not always measure individual particles

- A “jet” is a narrow cone of **hadrons** and other particles produced by the **hadronization** of a quark or gluon
- Jets are often best measured by total absorption rather than measurement of individual particles
- Processes creating jets are complicated
 - Parton fragmentation, with electromagnetic or hadronic showering in the detector
- Jet reconstruction is difficult
- Jet energy scale and reconstruction is large source of uncertainty

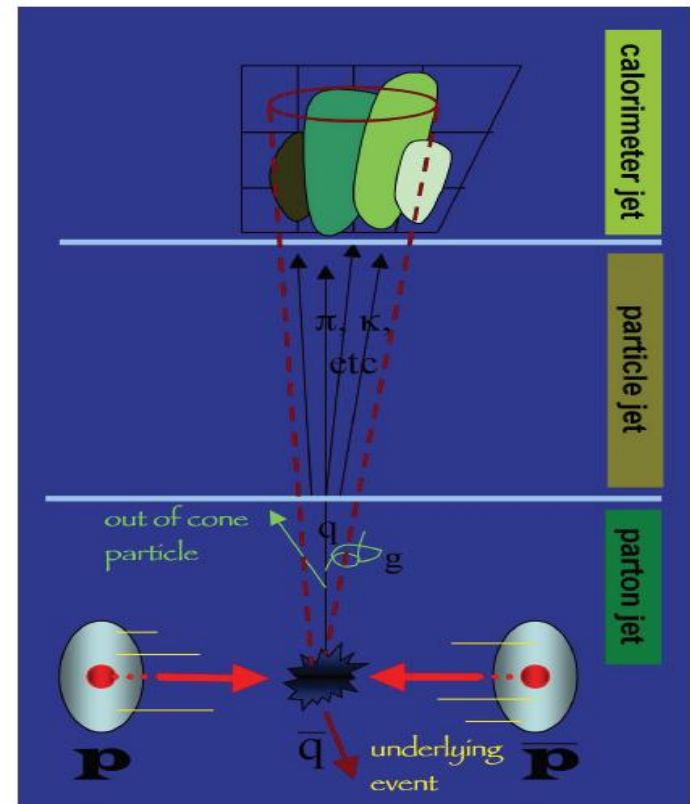
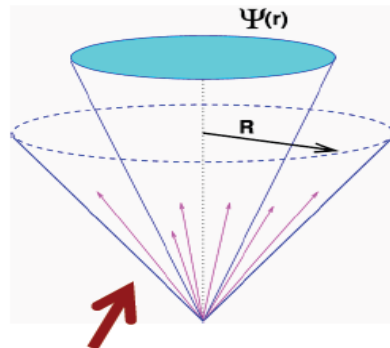

- Measure energy in a “cone”

The ATLAS detector

Muon Spectrometer ($|\eta| < 2.7$): air-core toroids with gas-based chambers
 Muon trigger and measurement with momentum resolution $< 10\%$ up to $E_\mu \sim \text{TeV}$

Length : ~ 46 m
 Radius : ~ 12 m
 Weight : ~ 7000 tons
 $\sim 10^8$ electronic channels

3-level trigger
 reducing the rate
 from 40 MHz to
 ~ 200 Hz

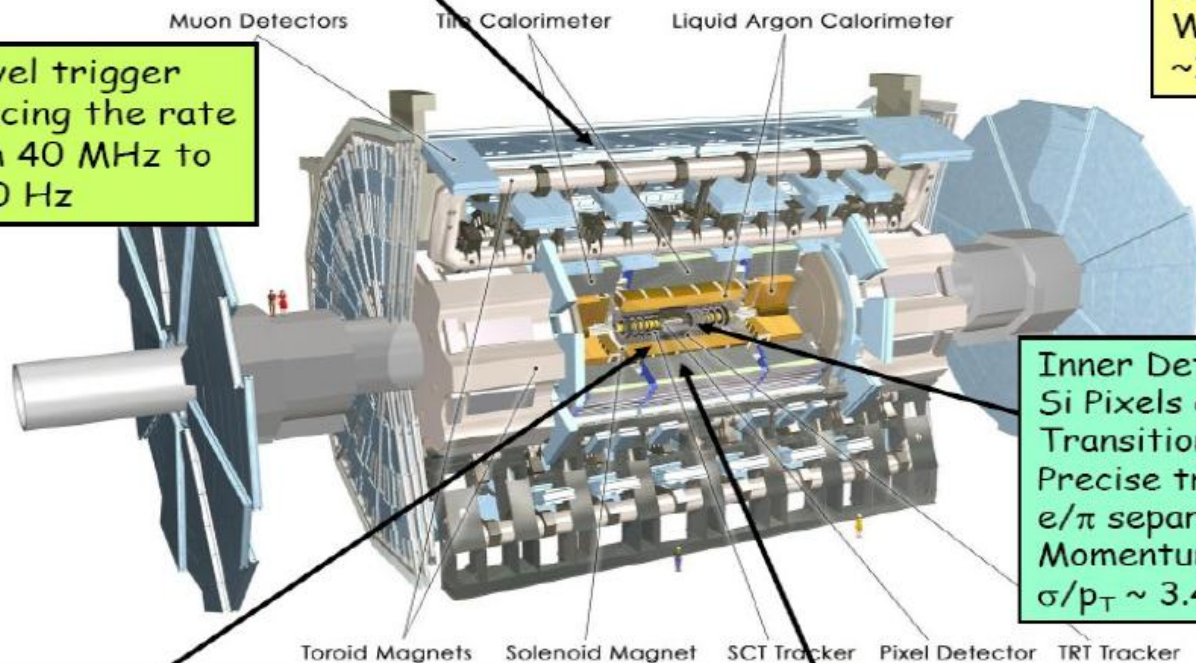

Inner Detector ($|\eta| < 2.5, B=2\text{T}$):
 Si Pixels and strips (SCT) +
 Transition Radiation straws
 Precise tracking and vertexing,
 e/π separation (TRT).
 Momentum resolution:
 $\sigma/p_T \sim 3.4 \times 10^{-4} p_T (\text{GeV}) \oplus 0.015$

EM calorimeter: Pb-LAr Accordion
 e/γ trigger, identification and measurement
 E-resolution: $\sim 1\%$ at 100 GeV, 0.5% at 1 TeV

HAD calorimetry ($|\eta| < 5$): segmentation, hermeticity
 Tilecal Fe/scintillator (central), Cu/W-LAr (fwd)
 Trigger and measurement of jets and missing E_T
 E-resolution: $\sigma/E \sim 50\%/\sqrt{E} \oplus 0.03$

Detectors are imperfect

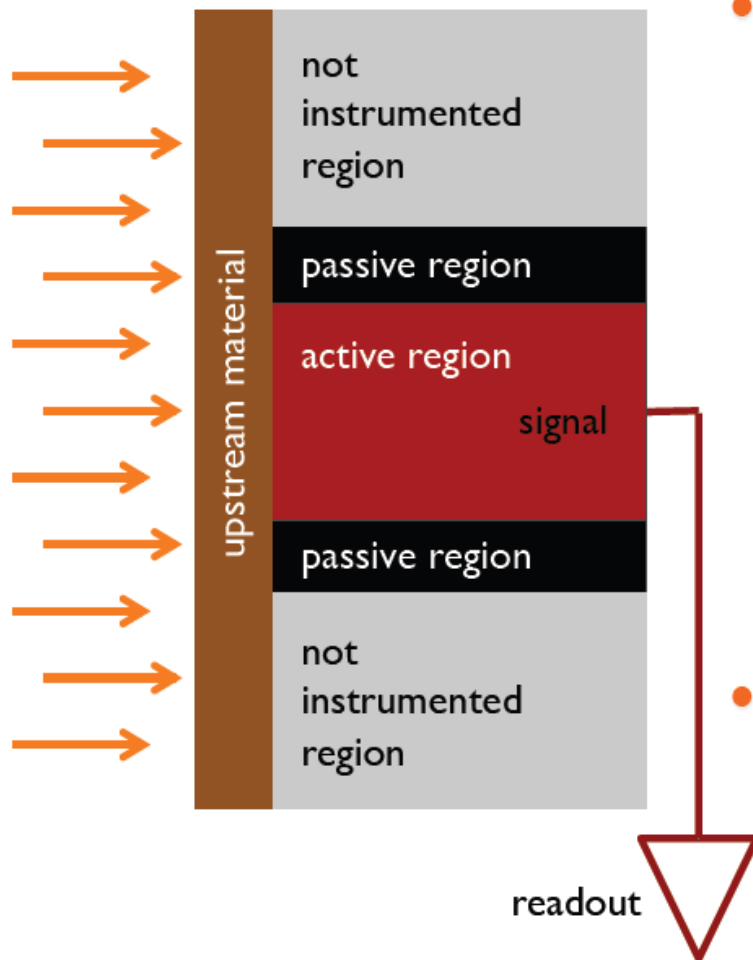

- **Detection efficiency**

$$\varepsilon = \frac{N_{\text{detected}}}{N_{\text{incident}}} = M \cdot R \cdot D$$

- ✓ **M = P(entering active region)**

- Upstream material, entrance windows, ...

- ✓ **R = P(generating signal)**

- Interaction cross sections, response, fluctuations, ...

- ✓ **D = P(signal gets registered)**

- Readout properties, thresholds, ...

- **Acceptance**

- ✓ **Instrumented/reactive region of the phase space (e.g. pseudorapidity, azimuthal angle, but also energy/momentum)**

- dynamic range

Nuclear Instruments & Methods in Physics Research

topical issue

Instrumentation and detector technologies for frontier high energy physics

Volume 666, pages 1 - 222 (21 February 2012)

Edited by:

Archana Sharma (CERN)

Technological advances in radiation detection have been pioneered and led by particle physics. The ever increasing complexity of the experiments in high energy physics has driven the need for developments in high performance silicon and gaseous tracking detectors, electromagnetic and hadron calorimetry, transition radiation detectors and novel particle identification techniques. Magnet systems have evolved with superconducting magnets being used in present and, are being designed for use in, future experiments. The alignment system, being critical for the overall detector performance, has become one of the essential design aspects of large experiments. The electronic developments go hand in hand to enable the exploitation of these detectors designed to operate in the hostile conditions of radiation, high rate and luminosity. This volume provides a panorama of the state-of-the-art in the field of radiation detection and instrumentation for large experiments at the present and future particle accelerators.

Summary

Detectors are designed and built to make specific physics measurements i.e. detectors are very specific for each physics subject

Detector techniques are based on particle interaction with matter ultimately on very low energy interactions.

The detector properties and their performance are the key to high quality physics results.

Instrumentation is evolving fast; physics requirements are increasing (rarer and rarer processes, precision measurements): each generation of detector has improved performance with respect to the preceding generation.

Credits: a lot of material in this lecture are from lectures by D. Fournier (EDIT 2011) , M. Delmastro ESIPAP 2014) and I. Wingerter-Seez (CERN Summer Student program 2017).

Data Flow for Physics Analysis

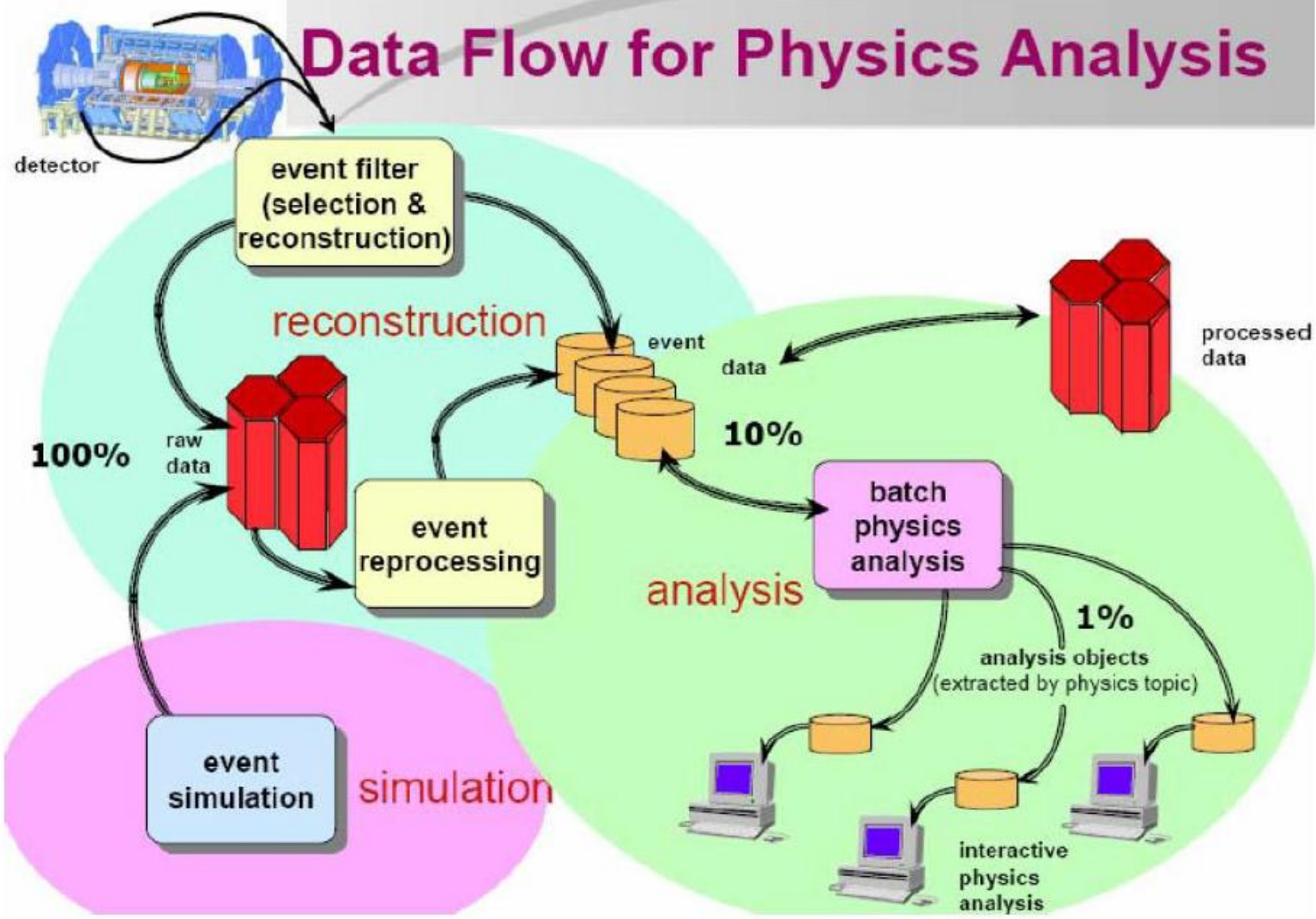

Worldwide LHC Computing Grid WLCG

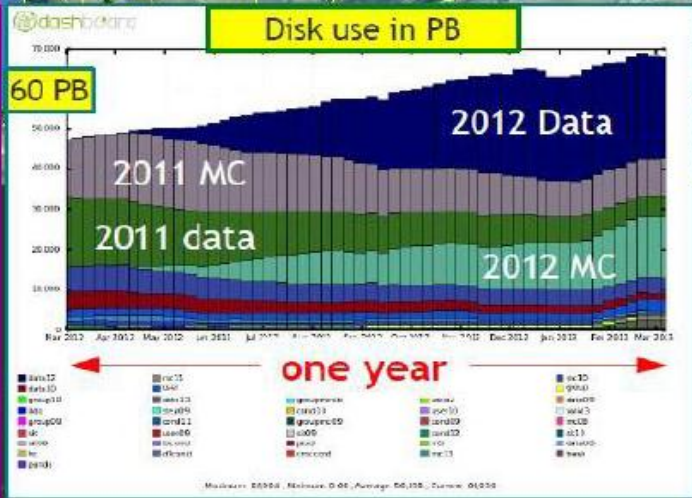
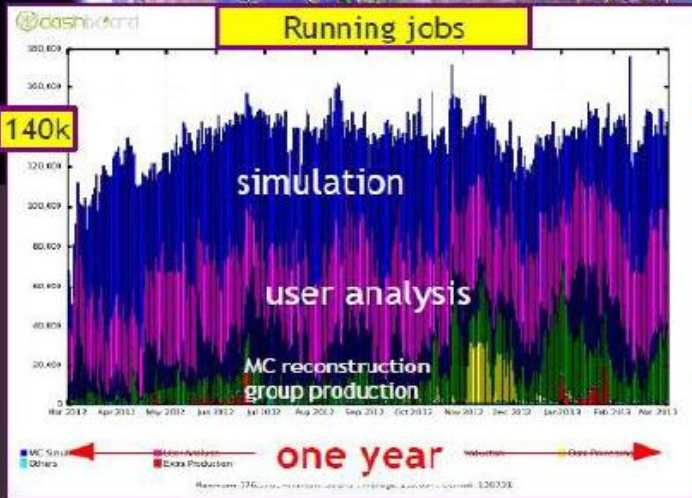

ATLAS uses ~80 WLCG sites world-wide Performance is superb

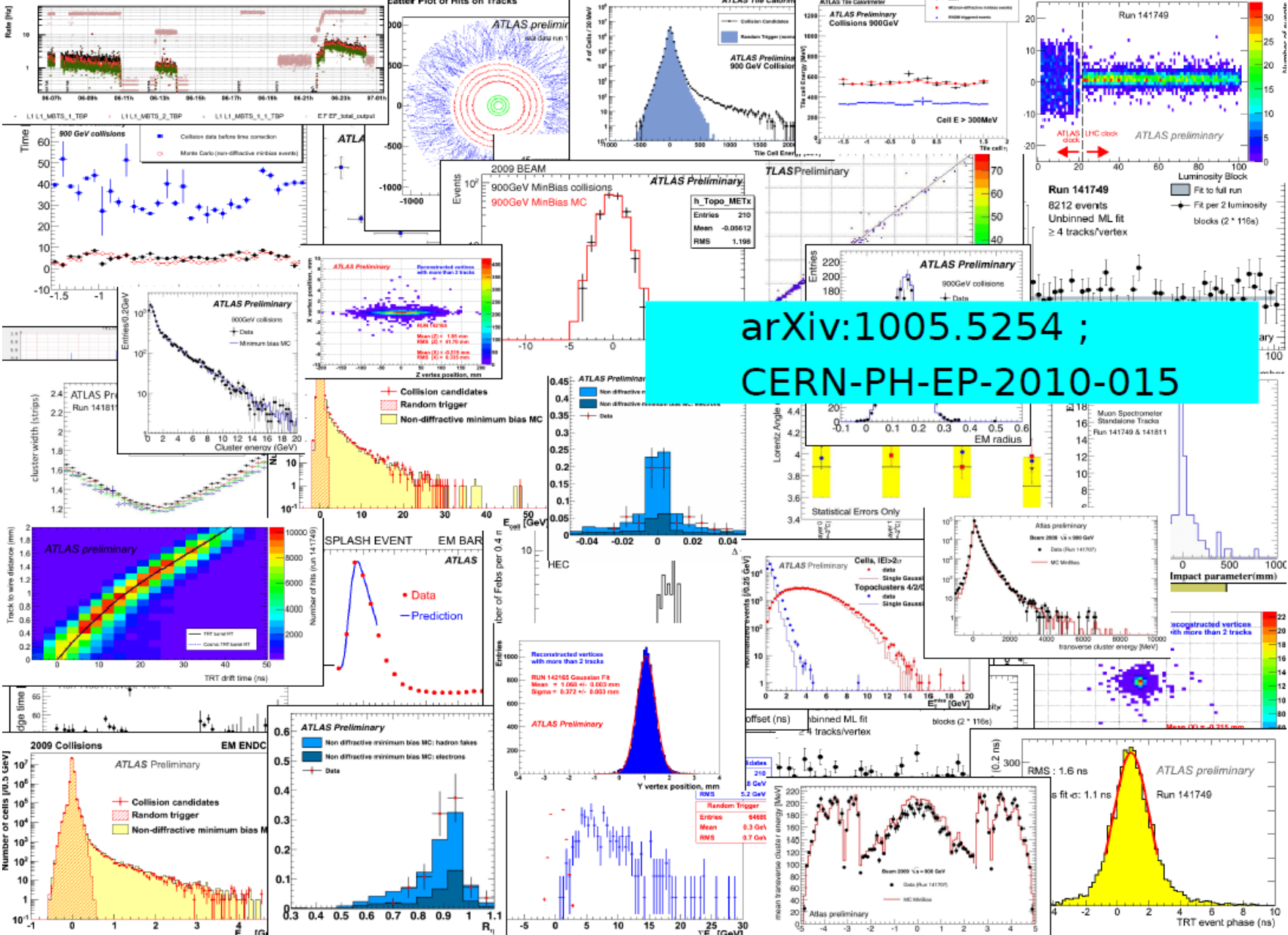

arXiv:1005.5254 ;
 CERN-PH-EP-2010-015