

Elementary Particle Physics: theory and experiments

Electron-proton elastic scattering



Follow the course/slides from M. A. Thomson lectures at Cambridge University

Prof. dr hab. Elżbieta Richter-Wąs

Electron-Proton Scattering

- In this handout aiming towards a study of electron-proton scattering as a probe of the structure of the proton

- Two main topics:

- $e^-p \rightarrow e^-p$ elastic scattering
- $e^-p \rightarrow e^-X$ deep inelastic scattering

- But first consider scattering from a point-like particle e.g.

$$e^- \mu^- \rightarrow e^- \mu^-$$

i.e. the QED part of
 $(e^-q \rightarrow e^-q)$

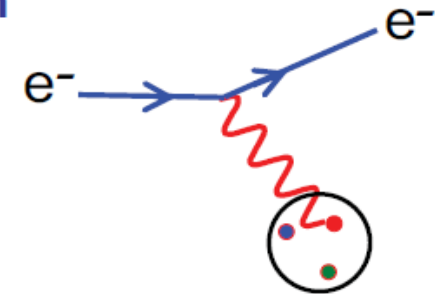
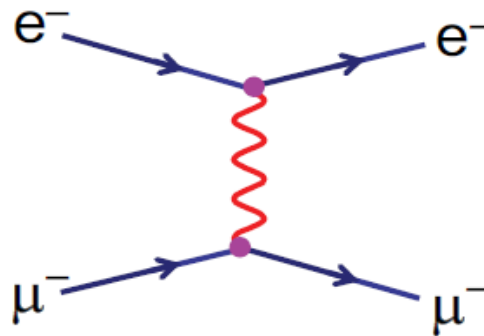

- Two ways to proceed:

- perform QED calculation from scratch

$$\langle |M_{fi}|^2 \rangle = \frac{8e^4}{(p_1 - p_3)^4} [(p_1 \cdot p_2)(p_3 \cdot p_4) + (p_1 \cdot p_4)(p_2 \cdot p_3)] \quad (1)$$

- take results from $e^+e^- \rightarrow \mu^+\mu^-$ and use **“Crossing Symmetry”** to obtain the matrix element for $e^- \mu^- \rightarrow e^- \mu^-$

Crossing Symmetry

- ★ Having derived the Lorentz invariant matrix element for $e^+e^- \rightarrow \mu^+\mu^-$ “rotate” the diagram to correspond to $e^-\mu^- \rightarrow e^-\mu^-$ and apply the principle of crossing symmetry to write down the matrix element !

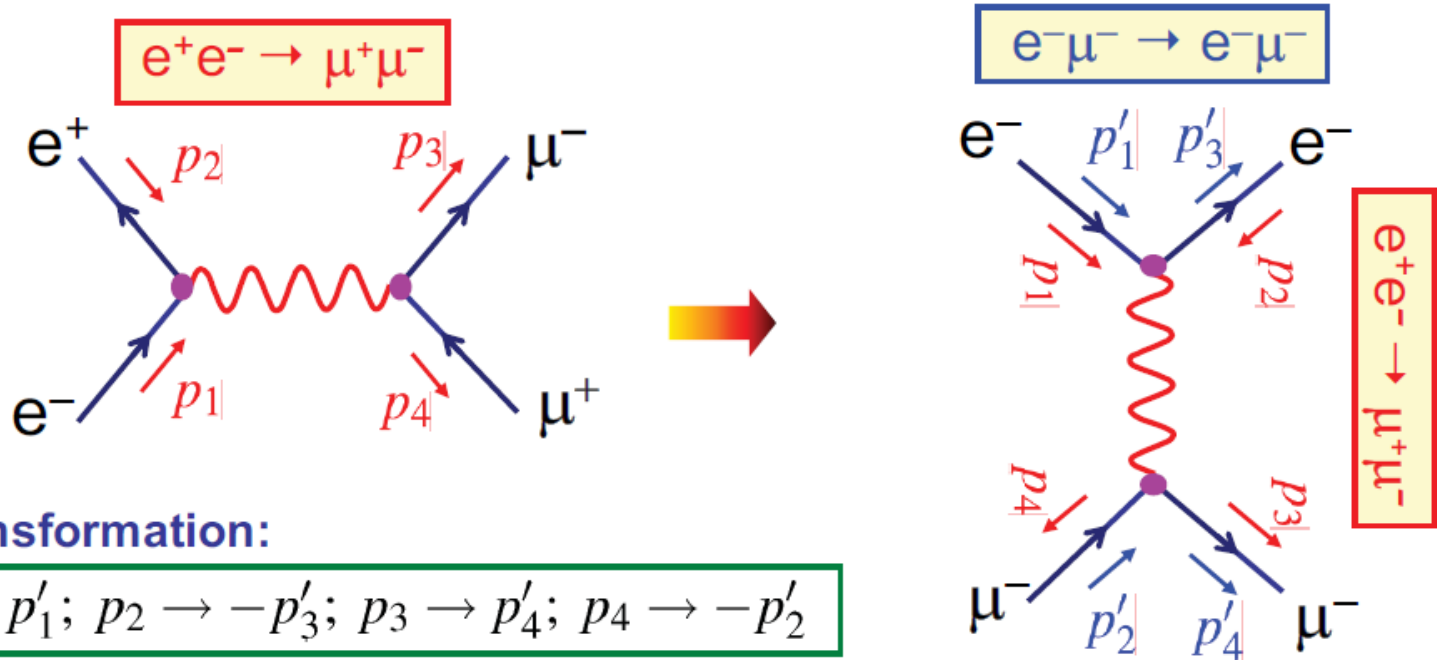

Changes the spin averaged matrix element for

$$\begin{array}{ccc}
 \boxed{e^- e^+ \rightarrow \mu^- \mu^+} & \longrightarrow & \boxed{e^- \mu^- \rightarrow e^- \mu^-} \\
 p_1 \ p_2 \quad p_3 \ p_4 & & p'_1 \ p'_2 \quad p'_3 \ p'_4
 \end{array}$$

- Take ME for $e^+e^- \rightarrow \mu^+\mu^-$ (and apply crossing symmetry):

$$\langle |M_{fi}|^2 \rangle = 2e^4 \frac{(p_1 \cdot p_3)^2 + (p_1 \cdot p_4)^2}{(p_1 \cdot p_2)^2} \quad \longrightarrow \quad \boxed{\langle |M_{fi}|^2 \rangle = 2e^4 \frac{(p'_1 \cdot p'_4)^2 + (p'_1 \cdot p'_2)^2}{(p'_1 \cdot p'_3)^2}} \quad (1)$$

Electron-Proton Scattering

$$\langle |M_{fi}|^2 \rangle = 2e^4 \frac{(p_1 \cdot p_4)^2 + (p_1 \cdot p_2)^2}{(p_1 \cdot p_3)^2} \quad (2)$$

$$\equiv 2e^4 \left(\frac{s^2 + u^2}{t^2} \right)$$

- Work in the C.o.M:

$$p_1 = (E, 0, 0, E) \quad p_2 = (E, 0, 0, -E)$$

$$p_3 = (E, E \sin \theta, 0, E \cos \theta)$$

$$p_4 = (E, -E \sin \theta, 0, -E \cos \theta)$$

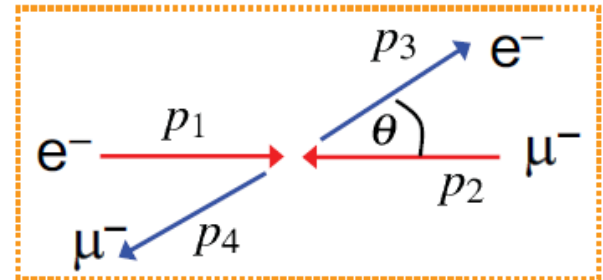

giving $p_1 \cdot p_2 = 2E^2$; $p_1 \cdot p_3 = E^2(1 - \cos \theta)$; $p_1 \cdot p_4 = E^2(1 + \cos \theta)$

$$\langle |M_{fi}|^2 \rangle = 2e^4 \frac{E^4(1 + \cos \theta)^2 + 4E^4}{E^4(1 - \cos \theta)^2}$$

$$\frac{d\sigma}{d\Omega} = \frac{1}{64\pi^2 s} \langle |M_{fi}|^2 \rangle = \frac{e^4}{8\pi^2 s} \frac{[1 + \frac{1}{4}(1 + \cos \theta)^2]}{(1 - \cos \theta)^2}$$



- The denominator arises from the propagator $-ig_{\mu\nu}/q^2$

here $q^2 = (p_1 - p_3)^2 = E^2(1 - \cos \theta)$

as $q^2 \rightarrow 0$ the cross section tends to infinity.

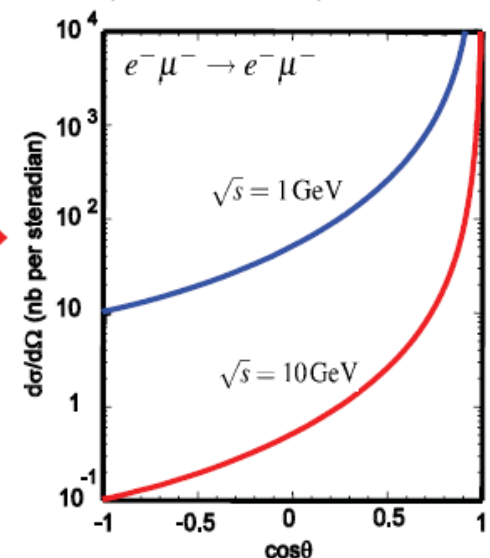

- What about the angular dependence of the **numerator** ?

$$\frac{d\sigma}{d\Omega} = \frac{e^4}{8\pi^2 s} \frac{[1 + \frac{1}{4}(1 + \cos\theta)^2]}{(1 - \cos\theta)^2}$$

- The factor $1 + \frac{1}{4}(1 + \cos\theta)^2$ reflects helicity (really chiral) structure of QED
- Of the 16 possible helicity combinations only 4 are non-zero:

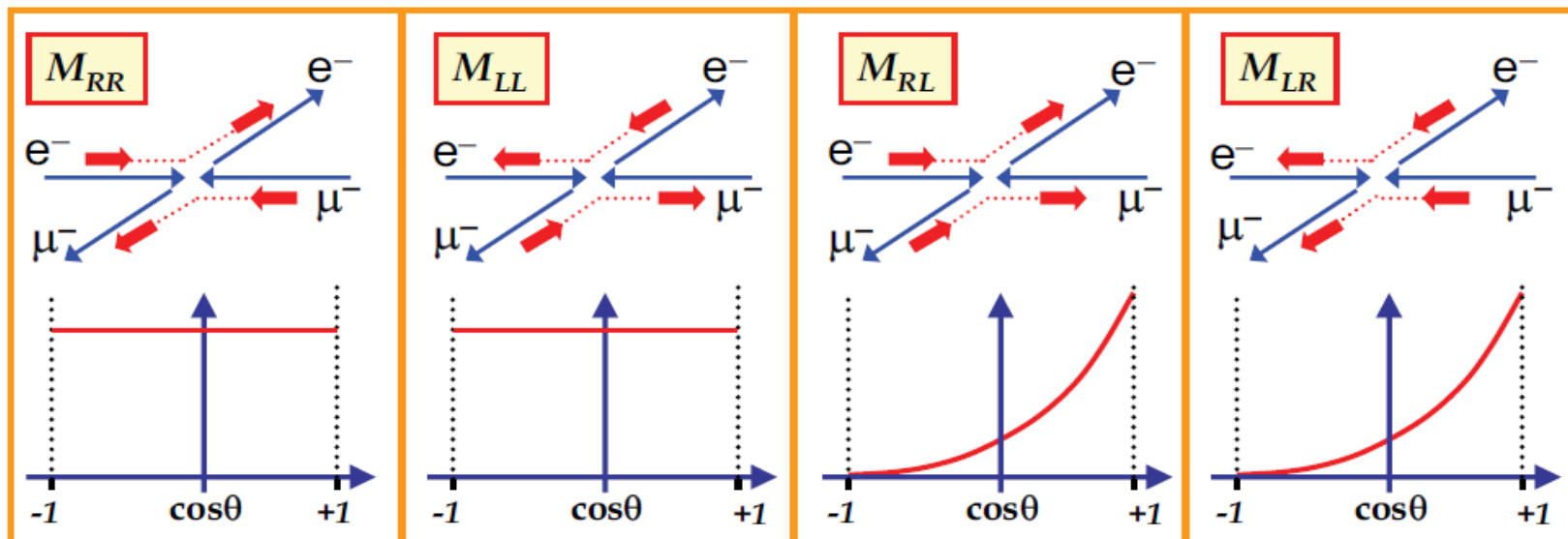

$$S_z = 0$$

$$\rightarrow \frac{d\sigma}{d\Omega} \propto 1$$

i.e. no preferred polar angle

$$S_z = +1$$

$$S_z = -1$$

$$\rightarrow \frac{d\sigma}{d\Omega} \propto \frac{1}{4}(1 + \cos\theta)^2$$

spin 1 rotation again

- The cross section calculated above is appropriate for the scattering of two spin half Dirac (i.e. point-like) particles in the ultra-relativistic limit (where both electron and muon masses can be neglected). In this case

$$\langle |M_{fi}|^2 \rangle = 2e^4 \frac{(p_1 \cdot p_4)^2 + (p_1 \cdot p_2)^2}{(p_1 \cdot p_3)^2}$$

- We will use this again in the discussion of “Deep Inelastic Scattering” of **electrons** from the **quarks** within a proton
- Before doing so we will consider the scattering of electrons from the composite proton - i.e. how do we know the proton isn't fundamental “point-like” particle ?
- In this discussion we will not be able to use the relativistic limit and require the general expression for the matrix element

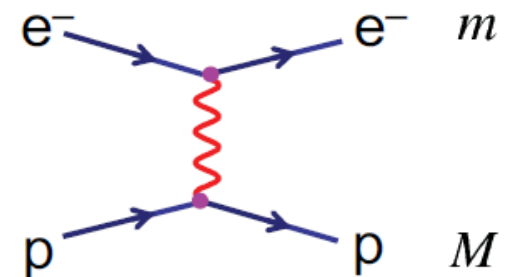

$$\langle |M_{fi}|^2 \rangle = \frac{8e^4}{(p_1 - p_3)^4} [(p_1 \cdot p_2)(p_3 \cdot p_4) + (p_1 \cdot p_4)(p_2 \cdot p_3) - (p_1 \cdot p_3)M^2 - (p_1 \cdot p_4)m^2 + 2m^2M^2] \quad (3)$$

Probing the structure of the proton

★ In $e^-p \rightarrow e^-p$ scattering the nature of the interaction of the virtual photon with the proton depends strongly on wavelength

- ♦ At **very low** electron energies $\lambda \gg r_p$:
the scattering is equivalent to that from a “point-like” spin-less object
- ♦ At **low** electron energies $\lambda \sim r_p$:
the scattering is equivalent to that from an extended charged object
- ♦ At **high** electron energies $\lambda < r_p$:
the wavelength is sufficiently short to resolve sub-structure. Scattering from constituent quarks
- ♦ At **very high** electron energies $\lambda \ll r_p$:
the proton appears to be a sea of quarks and gluons.

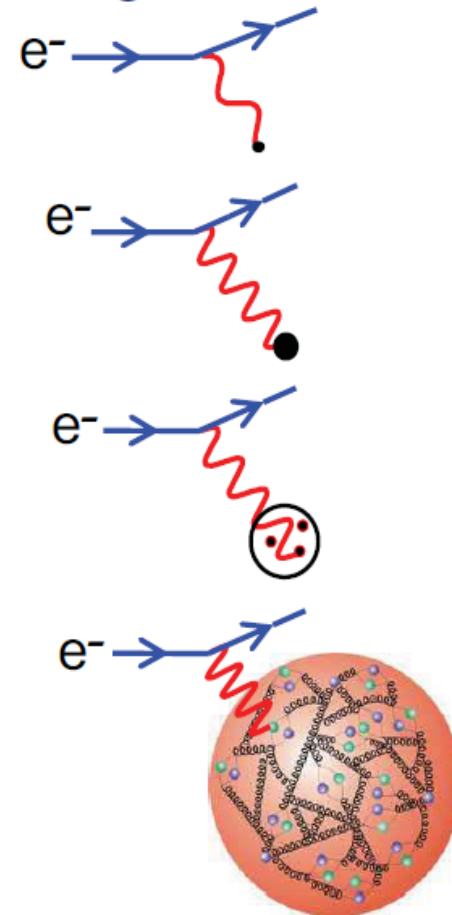

Rutherford Scattering Revisited

- ★ Rutherford scattering is the **low energy limit** where the recoil of the proton can be neglected and the **electron is non-relativistic**

- Start from RH and LH Helicity particle spinors

$$u_{\uparrow} = N \begin{pmatrix} c \\ e^{i\phi} s \\ \frac{|\vec{p}|}{E+m} c \\ \frac{|\vec{p}|}{E+m} e^{i\phi} s \end{pmatrix} \quad u_{\downarrow} = N \begin{pmatrix} -s \\ e^{i\phi} c \\ \frac{|\vec{p}|}{E+m} s \\ -\frac{|\vec{p}|}{E+m} e^{i\phi} c \end{pmatrix} \quad \begin{aligned} N &= \sqrt{E+m}; \\ s &= \sin(\theta/2); \quad c = \cos(\theta/2) \end{aligned}$$

- Now write in terms of:

$$\alpha = \frac{|\vec{p}|}{E+m_e} \quad \begin{aligned} \text{Non-relativistic limit: } &\alpha \rightarrow 0 \\ \text{Ultra-relativistic limit: } &\alpha \rightarrow 1 \end{aligned}$$

$$\Rightarrow u_{\uparrow} = N \begin{pmatrix} c \\ e^{i\phi} s \\ \alpha c \\ \alpha e^{i\phi} s \end{pmatrix} \quad u_{\downarrow} = N \begin{pmatrix} -s \\ e^{i\phi} c \\ \alpha s \\ -\alpha e^{i\phi} c \end{pmatrix}$$

and the possible initial and final state electron spinors are:

$$u_{\uparrow}(p_1) = N_e \begin{pmatrix} 1 \\ 0 \\ \alpha \\ 0 \end{pmatrix} \quad u_{\downarrow}(p_1) = N_e \begin{pmatrix} 0 \\ 1 \\ 0 \\ -\alpha \end{pmatrix} \quad u_{\uparrow}(p_3) = N_e \begin{pmatrix} c \\ s \\ \alpha c \\ \alpha s \end{pmatrix} \quad u_{\downarrow}(p_3) = N_e \begin{pmatrix} -s \\ c \\ \alpha s \\ -\alpha c \end{pmatrix}$$

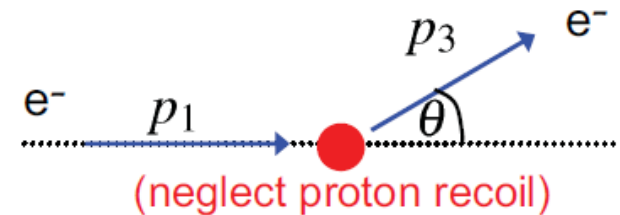

- Consider all four possible electron currents, i.e. Helicities **R→R, L→L, L→R, R→L**



$$\bar{u}_\uparrow(p_3)\gamma^\mu u_\uparrow(p_1) = (E + m_e) [(\alpha^2 + 1)c, 2\alpha s, -2i\alpha s, 2\alpha c] \quad (4)$$

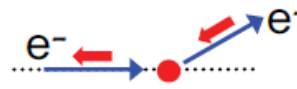

$$\bar{u}_\downarrow(p_3)\gamma^\mu u_\downarrow(p_1) = (E + m_e) [(\alpha^2 + 1)c, 2\alpha s, -2i\alpha s, 2\alpha c] \quad (5)$$

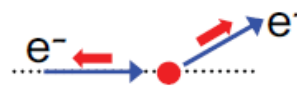

$$\bar{u}_\uparrow(p_3)\gamma^\mu u_\downarrow(p_1) = (E + m_e) [(1 - \alpha^2)s, 0, 0, 0] \quad (6)$$

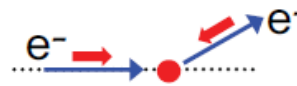

$$\bar{u}_\downarrow(p_3)\gamma^\mu u_\uparrow(p_1) = (E + m_e) [(\alpha^2 - 1)s, 0, 0, 0] \quad (7)$$

- In the relativistic limit ($\alpha = 1$), i.e. $E \gg m$

(6) and (7) are identically zero; only **R→R** and **L→L** combinations non-zero

- In the non-relativistic limit, $|\vec{p}| \ll E$ we have $\alpha = 0$

$$\bar{u}_\uparrow(p_3)\gamma^\mu u_\uparrow(p_1) = \bar{u}_\downarrow(p_3)\gamma^\mu u_\downarrow(p_1) = (2m_e) [c, 0, 0, 0]$$

$$\bar{u}_\uparrow(p_3)\gamma^\mu u_\downarrow(p_1) = -\bar{u}_\downarrow(p_3)\gamma^\mu u_\uparrow(p_1) = (2m_e) [s, 0, 0, 0]$$

All four electron helicity combinations have non-zero Matrix Element

i.e. Helicity eigenstates \neq Chirality eigenstates

- The initial and final state proton spinors (assuming no recoil) are:

$$u_{\uparrow}(0) = \sqrt{2M_p} \begin{pmatrix} 1 \\ 0 \\ 0 \\ 0 \end{pmatrix} \quad u_{\downarrow}(0) = \sqrt{2M_p} \begin{pmatrix} 0 \\ 1 \\ 0 \\ 0 \end{pmatrix}$$

Solutions of Dirac equation for a particle at rest

giving the proton currents:

$$j_{p\uparrow\uparrow} = j_{p\downarrow\downarrow} = 2M_p(1, 0, 0, 0)$$

$$j_{p\uparrow\downarrow} = j_{p\downarrow\uparrow} = 0$$

- The spin-averaged ME summing over the 8 allowed helicity states

$$\langle |M_{fi}^2| \rangle = \frac{1}{4} \frac{e^4}{q^4} (16M_p^2 m_e^2) \underline{(4c^2 + 4s^2)} = \frac{16M_p^2 m_e^2 e^4}{q^4}$$

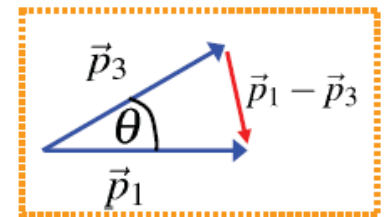

where $q^2 = (p_1 - p_3)^2 = (0, \vec{p}_1 - \vec{p}_3)^2 = -4|\vec{p}|^2 \sin^2(\theta/2)$

$$\langle |M_{fi}^2| \rangle = \frac{M_p^2 m_e^2 e^4}{|\vec{p}|^4 \sin^4(\theta/2)}$$

Note: in this limit all angular dependence is in the propagator

- The formula for the differential cross-section in the lab. frame was derived in handout 1:

$$\frac{d\sigma}{d\Omega} = \frac{1}{64\pi^2} \left(\frac{1}{M + E_1 - E_1 \cos \theta} \right)^2 |M_{fi}|^2 \quad (8)$$

- Here the electron is non-relativistic so $E \sim m_e \ll M_p$ and we can neglect E_1 in the denominator of equation (8)

$$\rightarrow \frac{d\sigma}{d\Omega} = \frac{1}{64\pi^2 M_p^2} |M_{fi}|^2 = \frac{m_e^2 e^4}{64\pi^2 |\vec{p}|^4 \sin^4(\theta/2)}$$

- Writing $e^2 = 4\pi\alpha$ and the kinetic energy of the electron as $E_K = p^2/2m_e$

$$\rightarrow \boxed{\left(\frac{d\sigma}{d\Omega}\right)_{\text{Rutherford}} = \frac{\alpha^2}{16E_K^2 \sin^4 \theta/2}} \quad (9)$$

- ★ This is the normal expression for the Rutherford cross section. It could have been derived by considering the scattering of a non-relativistic particle in the **static Coulomb potential** of the proton $V(\vec{r})$, without any consideration of the interaction due to the intrinsic magnetic moments of the electron or proton. From this we can conclude, that in this non-relativistic limit only the interaction between the **electric charges** of the particles matters.

The Mott Scattering Cross Section

- For Rutherford scattering we are in the limit where the target recoil is neglected and the scattered particle is non-relativistic $E_K \ll m_e$
- The limit where the target recoil is neglected and the scattered particle is **relativistic** (i.e. just neglect the electron mass) is called Mott Scattering
- In this limit the electron currents, equations (4) and (6), become:

$$\bar{u}_\uparrow(p_3)\gamma^\mu u_\uparrow(p_1) = 2E [c, s, -is, c] \quad \bar{u}_\uparrow(p_3)\gamma^\mu u_\downarrow(p_1) = E [0, 0, 0, 0]$$

Relativistic \Rightarrow Electron "helicity conserved"

- It is then straightforward to obtain the result:

$$\rightarrow \left(\frac{d\sigma}{d\Omega} \right)_{\text{Mott}} = \underbrace{\frac{\alpha^2}{4E^2 \sin^4 \theta / 2}}_{\text{Rutherford formula with } E_K = E \ (E \gg m_e)} \underbrace{\cos^2 \frac{\theta}{2}}_{\text{Overlap between initial/final state electron wave-functions. Just QM of spin } 1/2} \quad (10)$$

Rutherford formula with $E_K = E$ ($E \gg m_e$)

Overlap between initial/final state electron wave-functions. Just QM of spin $1/2$



- ★ **NOTE:** we could have derived this expression from scattering of electrons in a static potential from a fixed point in space $V(\vec{r})$. The interaction is **ELECTRIC** rather than magnetic (spin-spin) in nature.
- ★ Still haven't taken into account the charge distribution of the proton.....

Form Factors

- Consider the scattering of an electron in the static potential due to an extended charge distribution.
- The potential at \vec{r} from the centre is given by:

$$V(\vec{r}) = \int \frac{Q\rho(\vec{r}')}{4\pi|\vec{r}-\vec{r}'|} d^3\vec{r}' \quad \text{with} \quad \int \rho(\vec{r})d^3\vec{r} = 1$$

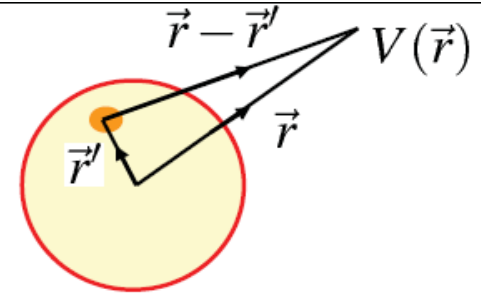

- In first order perturbation theory the matrix element is given by:

$$\begin{aligned} M_{fi} &= \langle \psi_f | V(\vec{r}) | \psi_i \rangle = \int e^{-i\vec{p}_3 \cdot \vec{r}} V(\vec{r}) e^{i\vec{p}_1 \cdot \vec{r}} d^3\vec{r} \\ &= \int \int e^{i\vec{q} \cdot \vec{r}} \frac{Q\rho(\vec{r}')}{4\pi|\vec{r}-\vec{r}'|} d^3\vec{r}' d^3\vec{r} = \int \int e^{i\vec{q} \cdot (\vec{r}-\vec{r}')} e^{i\vec{q} \cdot \vec{r}'} \frac{Q\rho(\vec{r}')}{4\pi|\vec{r}-\vec{r}'|} d^3\vec{r}' d^3\vec{r} \end{aligned}$$

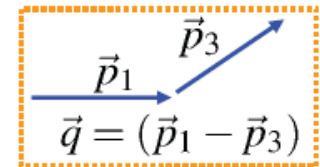

- Fix \vec{r}' and integrate over $d^3\vec{r}$ with substitution $\vec{R} = \vec{r} - \vec{r}'$

$$M_{fi} = \int e^{i\vec{q} \cdot \vec{R}} \frac{Q}{4\pi|\vec{R}|} d^3\vec{R} \int \rho(\vec{r}') e^{i\vec{q} \cdot \vec{r}'} d^3\vec{r}' = (M_{fi})_{point} F(\vec{q}^2)$$

- ★ The resulting matrix element is equivalent to the matrix element for scattering from a **point source** multiplied by the **form factor**

$$F(\vec{q}^2) = \int \rho(\vec{r}) e^{i\vec{q} \cdot \vec{r}} d^3\vec{r}$$

$$\left(\frac{d\sigma}{d\Omega}\right)_{\text{Mott}} \rightarrow \frac{\alpha^2}{4E^2 \sin^4 \theta/2} \cos^2 \frac{\theta}{2} |F(\vec{q}^2)|^2$$

- There is nothing mysterious about form factors – similar to diffraction of plane waves in optics.

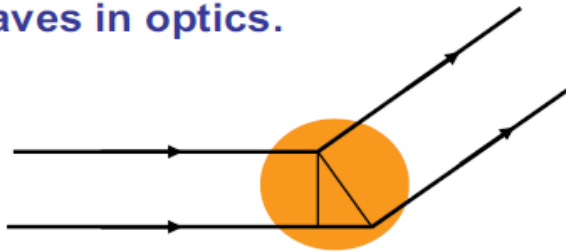

- The finite size of the scattering centre introduces a phase difference between plane waves “scattered from different points in space”. If wavelength is long compared to size all waves in phase and $F(\vec{q}^2) = 1$

For example:

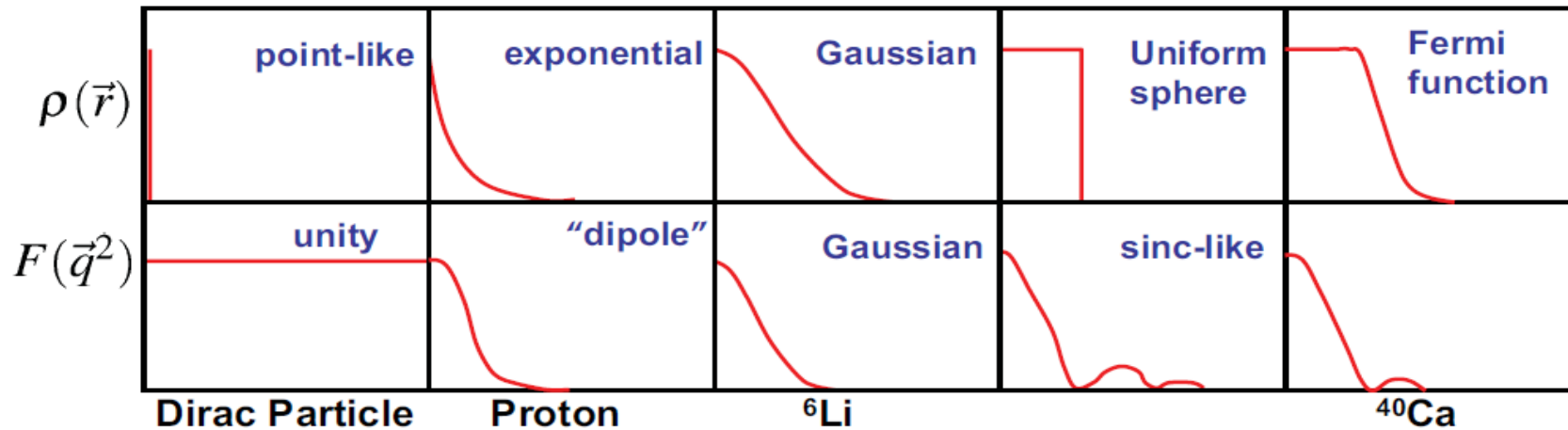

- **NOTE** that for a point charge the form factor is unity.

Point-like Electron-Proton Elastic Scattering

- So far have only considered the case we the proton does not recoil...

For $E_1 \gg m_e$ the general case is

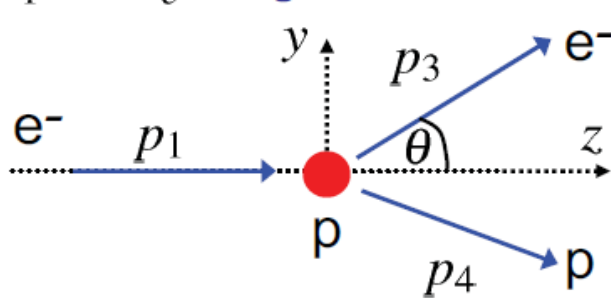

$$p_1 = (E_1, 0, 0, E_1)$$

$$p_2 = (M, 0, 0, 0)$$

$$p_3 = (E_3, 0, E_3 \sin \theta, E_3 \cos \theta)$$

$$p_4 = (E_4, \vec{p}_4)$$

- From Eqn. (2) with $m = m_e = 0$ the matrix element for this process is:

$$\langle |M_{fi}|^2 \rangle = \frac{8e^4}{(p_1 - p_3)^4} [(p_1 \cdot p_2)(p_3 \cdot p_4) + (p_1 \cdot p_4)(p_2 \cdot p_3) - (p_1 \cdot p_3)M^2] \quad (11)$$

- Experimentally observe scattered electron so eliminate p_4
- The scalar products not involving p_4 are:

$$p_1 \cdot p_2 = E_1 M \quad p_1 \cdot p_3 = E_1 E_3 (1 - \cos \theta) \quad p_2 \cdot p_3 = E_3 M$$

- From momentum conservation can eliminate p_4 : $p_4 = p_1 + p_2 - p_3$

$$p_3 \cdot p_4 = p_3 \cdot p_1 + p_3 \cdot p_2 - \cancel{p_3 \cdot p_3} = E_1 E_3 (1 - \cos \theta) + E_3 M$$

$$p_1 \cdot p_4 = \cancel{p_1 \cdot p_1} + p_1 \cdot p_2 - p_1 \cdot p_3 = E_1 M - E_1 E_3 (1 - \cos \theta)$$

$$p_1 \cdot p_1 = E_1^2 - |\vec{p}_1|^2 = m_e^2 \approx 0$$

i.e. neglect m_e

- Substituting these scalar products in Eqn. (11) gives

$$\begin{aligned}\langle |M_{fi}|^2 \rangle &= \frac{8e^4}{(p_1 - p_3)^4} M E_1 E_3 [(E_1 - E_3)(1 - \cos \theta) + M(1 + \cos \theta)] \\ &= \frac{8e^4}{(p_1 - p_3)^4} 2M E_1 E_3 [(E_1 - E_3) \sin^2(\theta/2) + M \cos^2(\theta/2)] \quad (12)\end{aligned}$$

- Now obtain expressions for $q^4 = (p_1 - p_3)^4$ and $(E_1 - E_3)$

$$q^2 = (p_1 - p_3)^2 = p_1^2 + p_3^2 - 2p_1 \cdot p_3 = -2E_1 E_3 (1 - \cos \theta) \quad (13)$$

$$= -4E_1 E_3 \sin^2 \theta / 2 \quad (14)$$

NOTE: $q^2 < 0$ Space-like

- For $(E_1 - E_3)$ start from

$$q \cdot p_2 = (p_1 - p_3) \cdot p_2 = M(E_1 - E_3)$$

and use $(q + p_2)^2 = p_4^2$ $q = (p_1 - p_3) = (p_4 - p_2)$

$$q^2 + p_2^2 + 2q \cdot p_2 = p_4^2$$

$$q^2 + M^2 + 2q \cdot p_2 = M^2$$

$$\rightarrow q \cdot p_2 = -q^2 / 2$$

- Hence the energy transferred to the proton:

$$E_1 - E_3 = -\frac{q^2}{2M} \quad (15)$$

Because q^2 is always negative $E_1 - E_3 > 0$ and the scattered electron is always lower in energy than the incoming electron

- Combining equations (11), (13) and (14):

$$\begin{aligned} \langle |M_{fi}|^2 \rangle &= \frac{8e^4}{16E_1^2 E_3^2 \sin^4 \theta/2} 2ME_1 E_3 \left[M \cos^2 \theta/2 - \frac{q^2}{2M} \sin^2 \theta/2 \right] \\ &= \frac{M^2 e^4}{E_1 E_3 \sin^4 \theta/2} \left[\cos^2 \theta/2 - \frac{q^2}{2M^2} \sin^2 \theta/2 \right] \end{aligned}$$

- For $E \gg m_e$ we have (see handout 1)

$$\frac{d\sigma}{d\Omega} = \frac{1}{64\pi^2} \left(\frac{E_3}{ME_1} \right)^2 |M_{fi}|^2$$

$$\alpha = \frac{e^2}{4\pi} \approx \frac{1}{137}$$



$$\frac{d\sigma}{d\Omega} = \frac{\alpha^2}{4E_1^2 \sin^4 \theta/2} \frac{E_3}{E_1} \left(\cos^2 \theta/2 - \frac{q^2}{2M^2} \sin^2 \theta/2 \right) \quad (16)$$

Interpretation

- So far have derived the differential cross-section for $e-p \rightarrow e-p$ **elastic** scattering assuming point-like Dirac spin $\frac{1}{2}$ particles. How should we interpret the equation?

$$\frac{d\sigma}{d\Omega} = \frac{\alpha^2}{4E_1^2 \sin^4 \theta/2} \frac{E_3}{E_1} \left(\cos^2 \theta/2 - \frac{q^2}{2M^2} \sin^2 \theta/2 \right)$$

- Compare with $\left(\frac{d\sigma}{d\Omega} \right)_{\text{Mott}} = \frac{\alpha^2}{4E^2 \sin^4 \theta/2} \cos^2 \frac{\theta}{2}$

the important thing to note about the Mott cross-section is that it is equivalent to scattering of spin $\frac{1}{2}$ electrons in a fixed **electro-static** potential. Here the term E_3/E_1 is due to the proton recoil.

$$\frac{d\sigma}{d\Omega} = \frac{\alpha^2}{4E_1^2 \sin^4 \theta/2} \frac{E_3}{E_1} \left(\cos^2 \theta/2 - \underbrace{\frac{q^2}{2M^2} \sin^2 \theta/2}_{\text{Magnetic interaction}} \right)$$

- the new term: $\propto \sin^2 \frac{\theta}{2}$



Magnetic interaction : due to the spin-spin interaction

- The above differential cross-section depends on a single parameter. For an electron scattering angle θ , both q^2 and the energy, E_3 , are fixed by kinematics

- Equating (13) and (15)

$$-2M(E_1 - E_3) = -2E_1E_3(1 - \cos \theta)$$

$$\rightarrow \frac{E_3}{E_1} = \frac{M}{M + E_1(1 - \cos \theta)}$$

- Substituting back into (13):

$$\rightarrow q^2 = -\frac{2ME_1^2(1 - \cos \theta)}{M + E_1(1 - \cos \theta)}$$

- e.g. $e^-p \rightarrow e^-p$ at $E_{\text{beam}} = 529.5$ MeV, look at scattered electrons at $\theta = 75^\circ$

For elastic scattering expect:

$$E_3 = \frac{ME_1}{M + E_1(1 - \cos \theta)}$$

$$E_3 = \frac{938 \times 529}{938 + 529(1 - \cos 75^\circ)} = 373 \text{ MeV}$$

The energy identifies the scatter as elastic.
Also know squared four-momentum transfer

$$|q^2| = \frac{2 \times 938 \times 529^2(1 - \cos 75^\circ)}{938 + 529(1 - \cos 75^\circ)} = 294 \text{ MeV}^2$$

E.B.Hughes et al., Phys. Rev. 139 (1965) B458

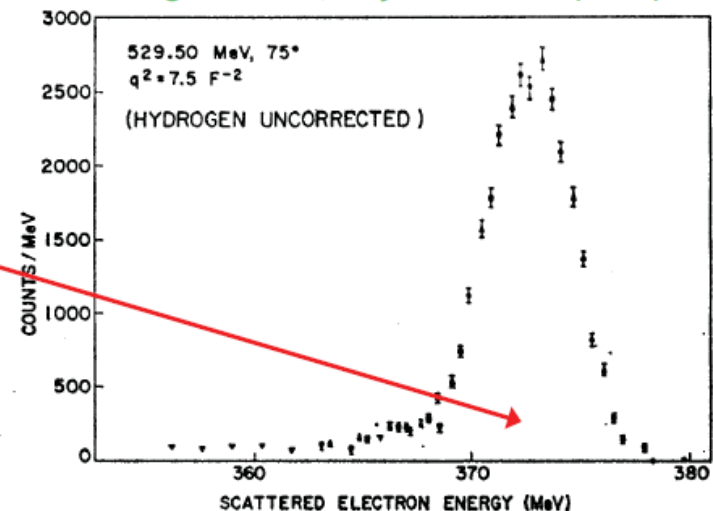

Elastic scattering from a Finite Size Proton

- ★ In general the finite size of the proton can be accounted for by introducing **two structure functions**. One related to the **charge distribution** in the proton, $G_E(q^2)$ and the other related to the distribution of the **magnetic moment** of the proton, $G_M(q^2)$

- It can be shown that equation (16) generalizes to the **ROSENBLUTH FORMULA**.

$$\frac{d\sigma}{d\Omega} = \frac{\alpha^2}{4E_1^2 \sin^4 \theta / 2} \frac{E_3}{E_1} \left(\frac{G_E^2 + \tau G_M^2}{(1 + \tau)} \cos^2 \frac{\theta}{2} + 2\tau G_M^2 \sin^2 \frac{\theta}{2} \right)$$

with the Lorentz Invariant quantity:

$$\tau = -\frac{q^2}{4M^2} > 0$$

- Unlike our previous discussion of form factors, here the form factors are a function of q^2 rather than \vec{q}^2 and cannot simply be considered in terms of the FT of the charge and magnetic moment distributions.

But $q^2 = (E_1 - E_3)^2 - \vec{q}^2$ and from eq (15) obtain

$$\rightarrow -\vec{q}^2 = q^2 \left[1 - \left(\frac{q}{2M} \right)^2 \right]$$

So for $\frac{q^2}{4M^2} \ll 1$ we have $q^2 \approx -\vec{q}^2$ and $G(q^2) \approx G(\vec{q}^2)$

- Hence in the limit $q^2/4M^2 \ll 1$ we can interpret the structure functions in terms of the Fourier transforms of the charge and magnetic moment distributions

$$G_E(q^2) \approx G_E(\vec{q}^2) = \int e^{i\vec{q}\cdot\vec{r}} \rho(\vec{r}) d^3\vec{r}$$

$$G_M(q^2) \approx G_M(\vec{q}^2) = \int e^{i\vec{q}\cdot\vec{r}} \mu(\vec{r}) d^3\vec{r}$$

- Note in deriving the Rosenbluth formula we assumed that the proton was a spin-half Dirac particle, i.e.

$$\vec{\mu} = \frac{e}{M} \vec{S}$$

- However, the experimentally measured value of the proton magnetic moment is larger than expected for a point-like Dirac particle:

$$\vec{\mu} = 2.79 \frac{e}{M} \vec{S}$$

So for the **proton** expect

$$G_E(0) = \int \rho(\vec{r}) d^3\vec{r} = 1 \quad G_M(0) = \int \mu(\vec{r}) d^3\vec{r} = \mu_p = +2.79$$

- Of course the anomalous magnetic moment of the proton is already evidence that it is not point-like !

Measuring $G_E(q^2)$ and $G_M(q^2)$

- Express the Rosenbluth formula as:

$$\frac{d\sigma}{d\Omega} = \left(\frac{d\sigma}{d\Omega}\right)_0 \left(\frac{G_E^2 + \tau G_M^2}{(1 + \tau)} + 2\tau G_M^2 \tan^2 \frac{\theta}{2} \right)$$

where $\left(\frac{d\sigma}{d\Omega}\right)_0 = \frac{\alpha^2}{4E_1^2 \sin^4 \theta/2} \frac{E_3}{E_1} \cos^2 \frac{\theta}{2}$

i.e. the Mott cross-section including the proton recoil. It corresponds to scattering from a spin-0 proton.

- At very low q^2 : $\tau = -q^2/4M^2 \approx 0$

$$\frac{d\sigma}{d\Omega} / \left(\frac{d\sigma}{d\Omega}\right)_0 \approx G_E^2(q^2)$$

- At high q^2 : $\tau \gg 1$

$$\frac{d\sigma}{d\Omega} / \left(\frac{d\sigma}{d\Omega}\right)_0 \approx \left(1 + 2\tau \tan^2 \frac{\theta}{2}\right) G_M^2(q^2)$$

- In general we are sensitive to both structure functions! These can be resolved from the angular dependence of the cross section at **FIXED** q^2

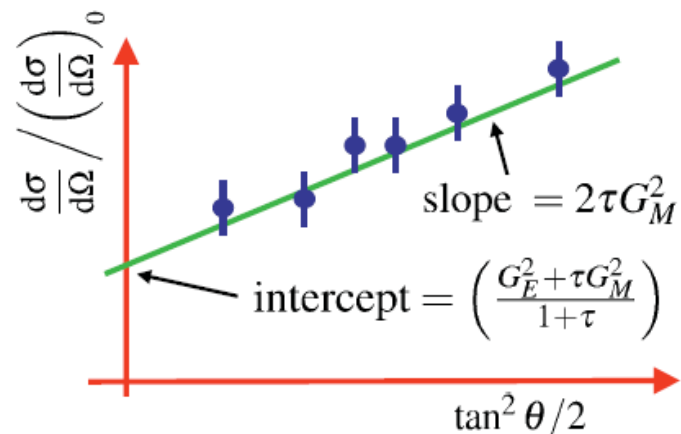

● **EXAMPLE:** $e^-p \rightarrow e^-p$ at $E_{\text{beam}} = 529.5 \text{ MeV}$

- Electron beam energies chosen to give certain values of q^2
- Cross sections measured to 2-3 %

E.B.Hughes et al., Phys. Rev. 139 (1965) B458

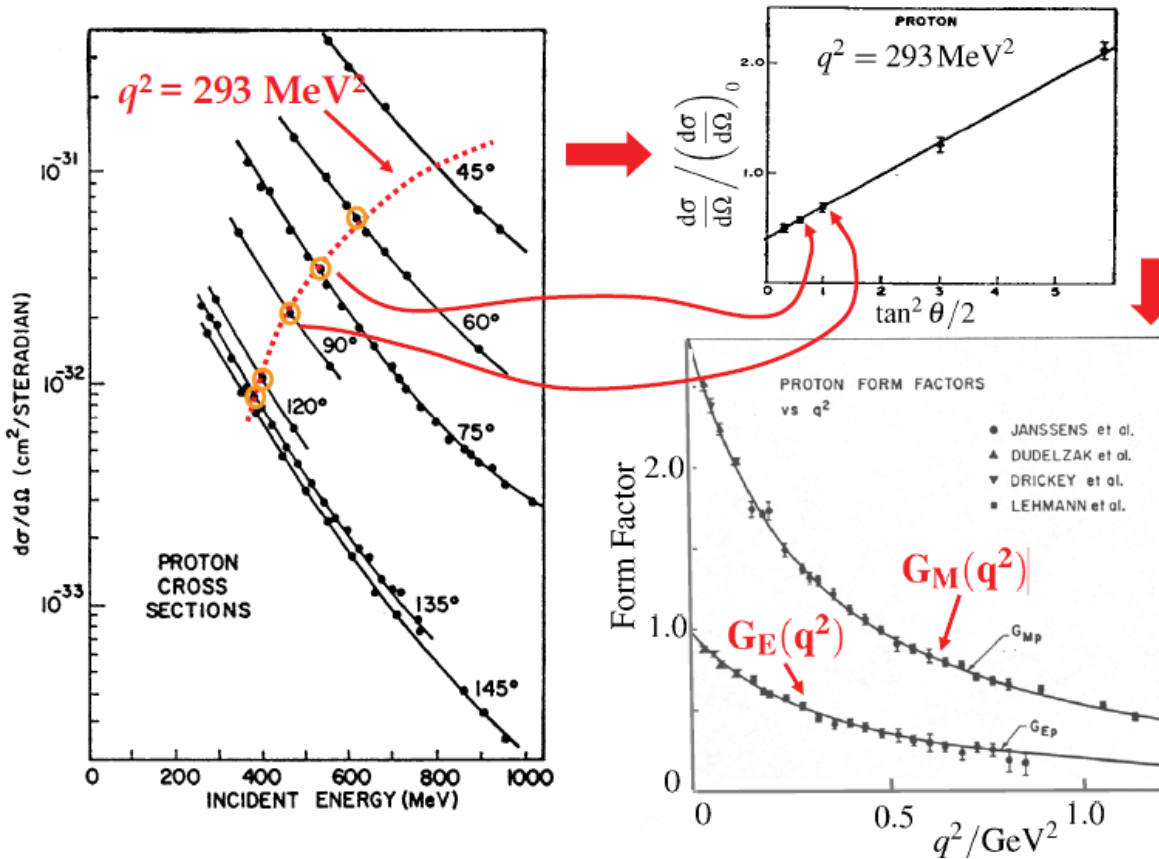

NOTE

Experimentally find $G_M(q^2) = 2.79G_E(q^2)$,
i.e. the electric and magnetic form factors have same distribution

Higher Energy Electron-Proton Scattering

★ Use electron beam from SLAC LINAC: $5 < E_{\text{beam}} < 20 \text{ GeV}$

- Detect scattered electrons using the "8 GeV Spectrometer"

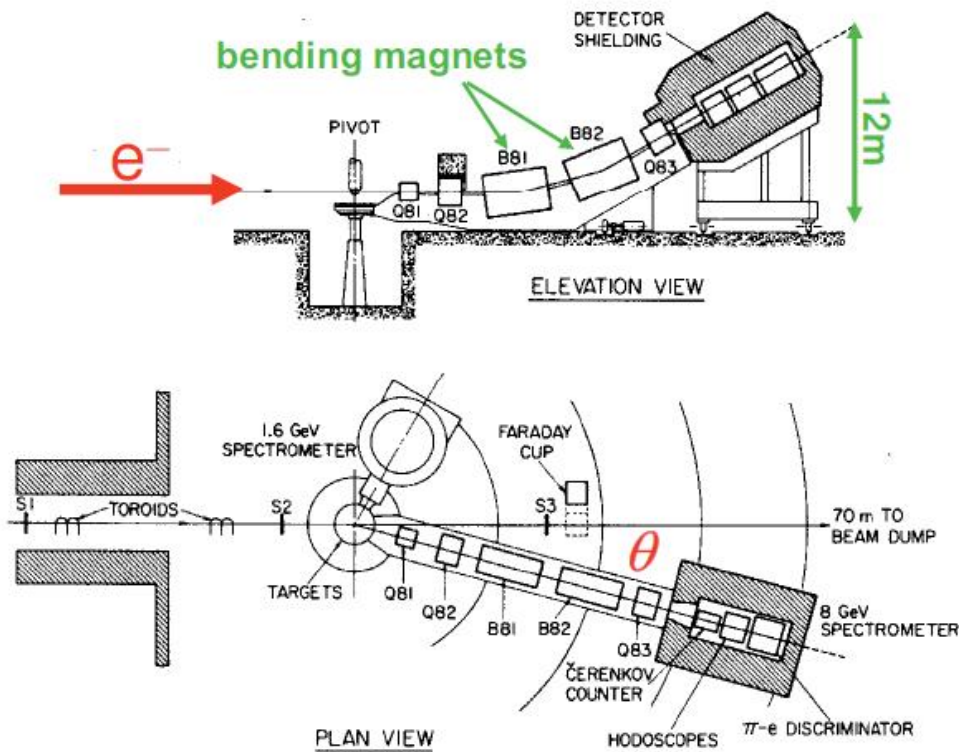

High $q^2 \rightarrow$ Measure $G_M(q^2)$

P.N.Kirk et al., Phys Rev D8 (1973) 63

High q^2 Results

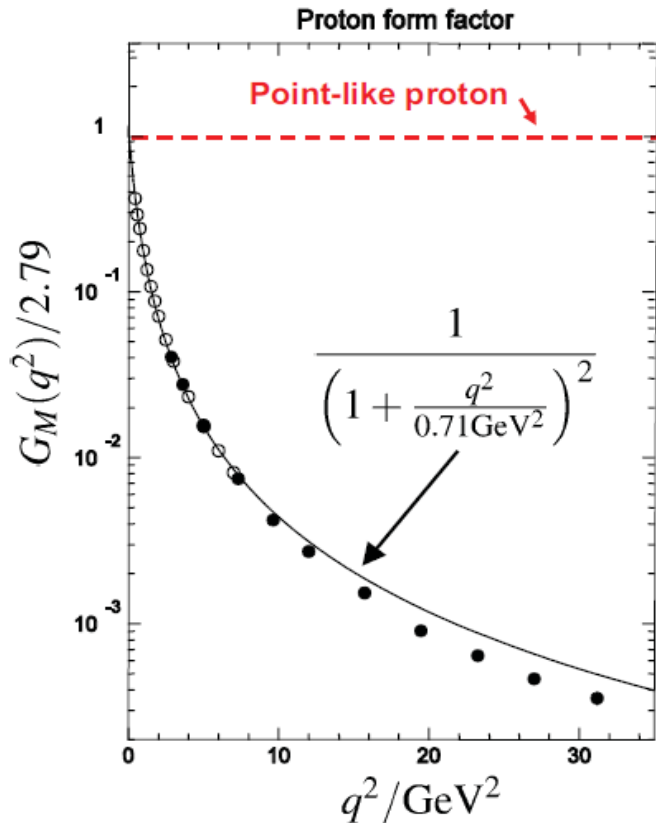

R.C.Walker et al., Phys. Rev. D49 (1994) 5671
A.F.Sill et al., Phys. Rev. D48 (1993) 29

- ★ Form factor falls rapidly with q^2
 - Proton is not point-like
 - Good fit to the data with “dipole form”:
- $$G_E^p(q^2) \approx \frac{G_M^p}{2.79} \approx \frac{1}{\left(1 + q^2/0.71 \text{ GeV}^2\right)^2}$$

- ★ Taking FT find spatial charge and magnetic moment distribution

$$\rho(r) \approx \rho_0 e^{-r/a}$$

with $a \approx 0.24 \text{ fm}$

- Corresponds to a rms charge radius
 $r_{rms} \approx 0.8 \text{ fm}$

- ★ Although suggestive, does not imply proton is composite !
- ★ Note: so far have only considered **ELASTIC scattering**; Inelastic scattering is the subject of next handout

Summary: Elastic Scattering

- ★ For elastic scattering of relativistic electrons from a point-like Dirac proton:

$$\frac{d\sigma}{d\Omega} = \frac{\alpha^2}{4E_1^2 \sin^4 \theta/2} \frac{E_3}{E_1} \left(\underbrace{\cos^2 \frac{\theta}{2}}_{\text{Rutherford}} - \underbrace{\frac{q^2}{2M^2} \sin^2 \frac{\theta}{2}}_{\text{Proton recoil}} \right)$$

Rutherford Proton recoil Electric/
Magnetic scattering Magnetic term due to spin

- ★ For elastic scattering of relativistic electrons from an extended proton:

$$\frac{d\sigma}{d\Omega} = \frac{\alpha^2}{4E_1^2 \sin^4 \theta/2} \frac{E_3}{E_1} \left(\frac{G_E^2 + \tau G_M^2}{(1 + \tau)} \cos^2 \frac{\theta}{2} + 2\tau G_M^2 \sin^2 \frac{\theta}{2} \right)$$

Rosenbluth Formula

- ★ Electron elastic scattering from protons demonstrates that the proton is an extended object with rms charge radius of ~ 0.8 fm

Deep Inelastic Scattering

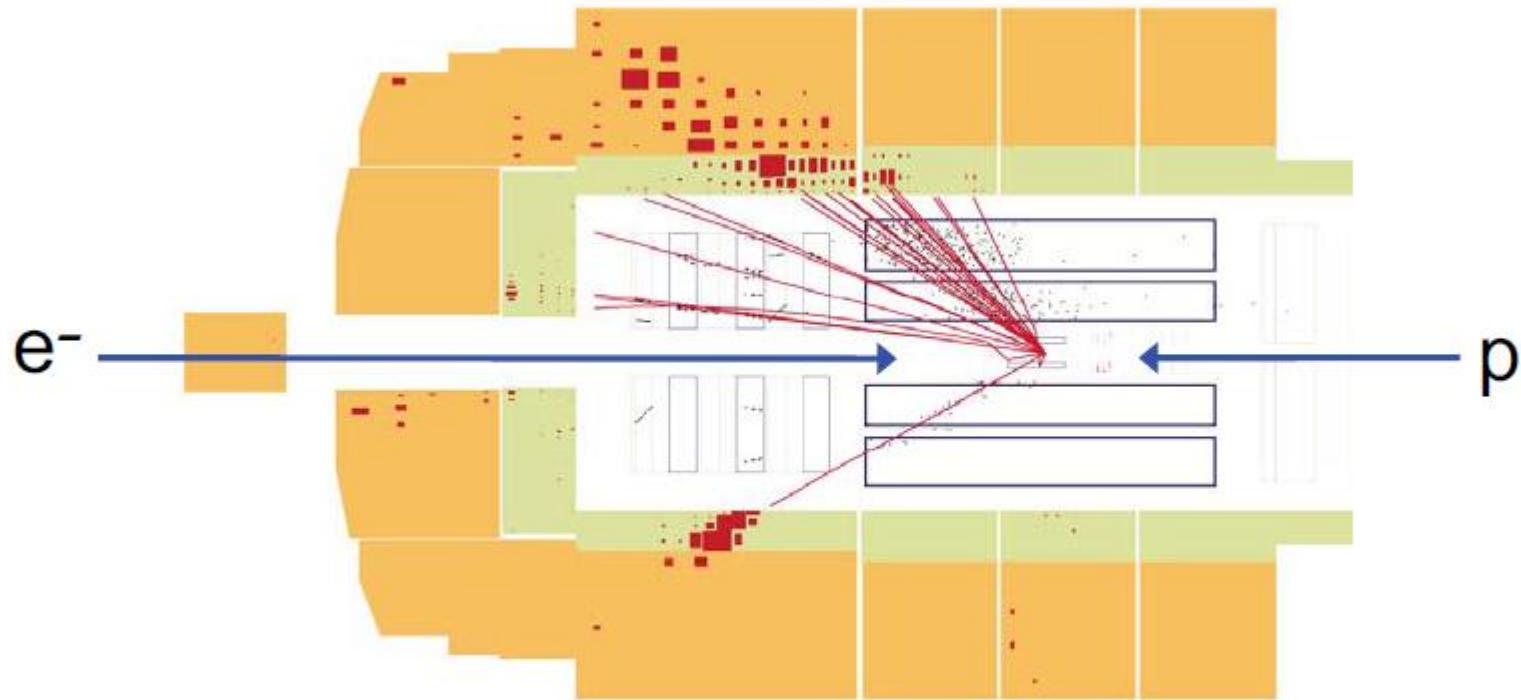

$e^- p$ Elastic Scattering at Very High q^2

★ At high q^2 the Rosenbluth expression for elastic scattering becomes

$$\left(\frac{d\sigma}{d\Omega}\right)_{elastic} = \frac{\alpha^2}{4E_1^2 \sin^4 \theta/2} \frac{E_3}{E_1} \left(\frac{q^2}{2M^2} G_M^2 \sin^2 \frac{\theta}{2}\right) \quad \tau = -\frac{q^2}{4M^2} \gg 1$$

• From $e^- p$ elastic scattering, the proton magnetic form factor is

$$G_M(q^2) \approx \frac{1}{(1 + q^2/0.71\text{GeV}^2)^2} \quad \rightarrow \quad G_M(q^2) \propto q^{-4} \quad \text{at high } q^2$$

$$\Rightarrow \left(\frac{d\sigma}{d\Omega}\right)_{elastic} \propto q^{-6}$$

• Due to the finite proton size, **elastic scattering** at high q^2 is unlikely and **inelastic reactions** where the proton breaks up dominate.

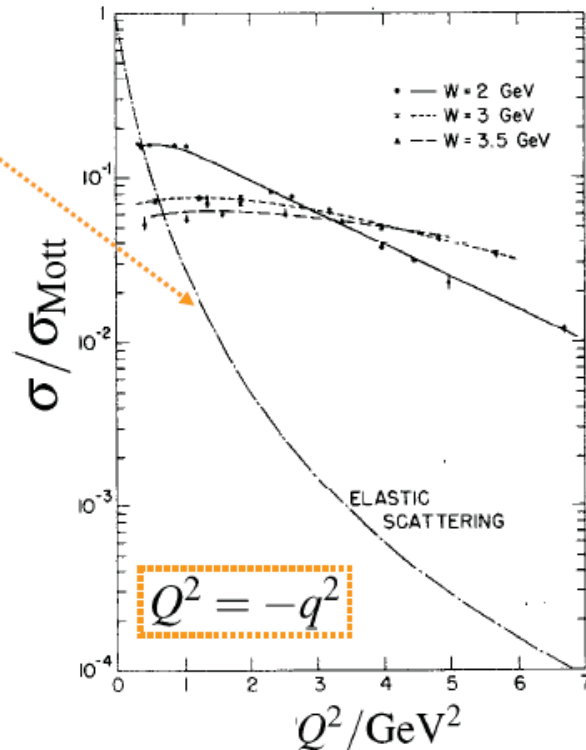
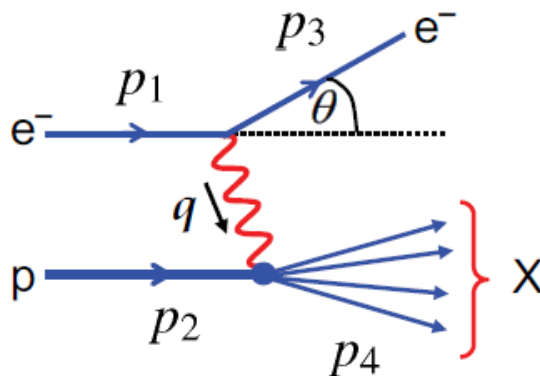

M. Breidenbach et al.,
Phys. Rev. Lett. 23 (1969) 935

Kinematics of Inelastic Scattering

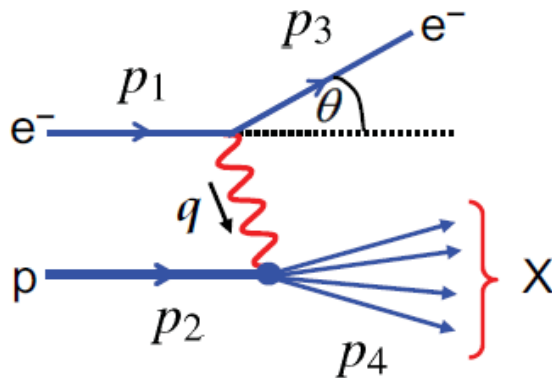

- For inelastic scattering the mass of the final state hadronic system is no longer the proton mass, M
- The final state hadronic system must contain at least one **baryon** which implies the final state invariant mass $M_X > M$

$$M_X^2 = p_4^2 = (E_4^2 - |\vec{p}_4|^2)$$

★ For inelastic scattering introduce four new kinematic variables: x, y, ν, Q^2

★ Define:

$$x \equiv \frac{Q^2}{2p_2 \cdot q}$$

Bjorken x

(Lorentz Invariant)

where

$$Q^2 \equiv -q^2$$

$$Q^2 > 0$$

• Here $M_X^2 = p_4^2 = (q + p_2)^2 = -Q^2 + 2p_2 \cdot q + M^2$

$\Rightarrow Q^2 = 2p_2 \cdot q + M^2 - M_X^2 \Rightarrow Q^2 \leq 2p_2 \cdot q$

Note: in many text books W is often used in place of M_X

hence $0 < x < 1$ **inelastic**

$x = 1$ **elastic**

Proton intact
 $M_X = M$

★ Define:

$$y \equiv \frac{p_2 \cdot q}{p_2 \cdot p_1} \quad (\text{Lorentz Invariant})$$

• In the Lab. Frame:

$$p_1 = (E_1, 0, 0, E_1) \quad p_2 = (M, 0, 0, 0)$$

$$q = (E_1 - E_3, \vec{p}_1 - \vec{p}_3)$$

$$\rightarrow y = \frac{M(E_1 - E_3)}{ME_1} = 1 - \frac{E_3}{E_1}$$

So y is the fractional energy loss of the incoming particle

$$0 < y < 1$$

• In the C.o.M. Frame (neglecting the electron and proton masses):

$$p_1 = (E, 0, 0, E); \quad p_2 = (E, 0, 0, -E); \quad p_3 = (E, E \sin \theta^*, 0, E \cos \theta^*)$$

$$\rightarrow y = \frac{1}{2}(1 - \cos \theta^*) \quad \text{for } E \gg M$$

★ Finally Define:

$$v \equiv \frac{p_2 \cdot q}{M} \quad (\text{Lorentz Invariant})$$

• In the Lab. Frame: $v = E_1 - E_3$

v is the energy lost by the incoming particle

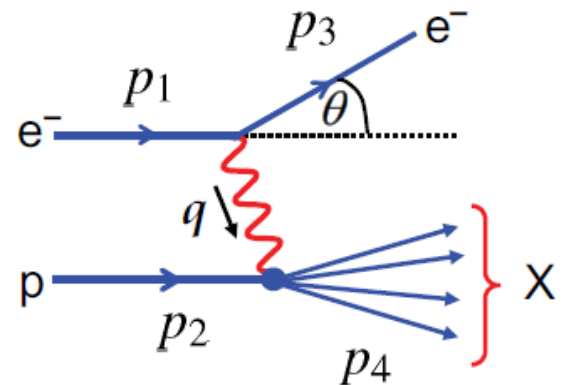

Relationships between Kinematic Variables

- Can rewrite the new kinematic variables in terms of the squared centre-of-mass energy, s , for the electron-proton collision

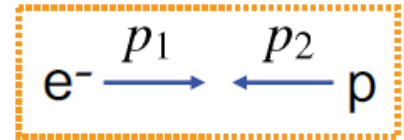

$$s = (p_1 + p_2)^2 = p_1^2 + p_2^2 + 2p_1 \cdot p_2 = 2p_1 \cdot p_2 + M^2 + \cancel{m_e^2}$$

$$2p_1 \cdot p_2 = s - M^2$$

Neglect mass of electron

- For a fixed centre-of-mass energy, it can then be shown that the four kinematic variables

$$Q^2 \equiv -q^2 \quad x \equiv \frac{Q^2}{2p_2 \cdot q} \quad y \equiv \frac{p_2 \cdot q}{p_2 \cdot p_1} \quad v \equiv \frac{p_2 \cdot q}{M}$$

are not independent.

- i.e. the scaling variables x and y can be expressed as

$$x = \frac{Q^2}{2Mv} \quad y = \frac{2M}{s - M^2} v$$

Note the simple relationship between y and v

and $xy = \frac{Q^2}{s - M^2} \Rightarrow Q^2 = (s - M^2)xy$

- For a fixed centre of mass energy, the interaction kinematics are completely defined by **any two** of the above kinematic variables (except y and v)
- For elastic scattering ($x = 1$) there is only one independent variable. As we saw previously if you measure electron scattering angle know everything else.

Inelastic Scattering

Example: Scattering of 4.879 GeV electrons from protons at rest

- Place detector at 10° to beam and measure the energies of scattered e^-
- Kinematics fully determined from the electron energy and angle !
- e.g. for this energy and angle : the invariant mass of the final state hadronic system $W^2 = M_X^2 = 10.06 - 2.03E_3$ (try and show this)

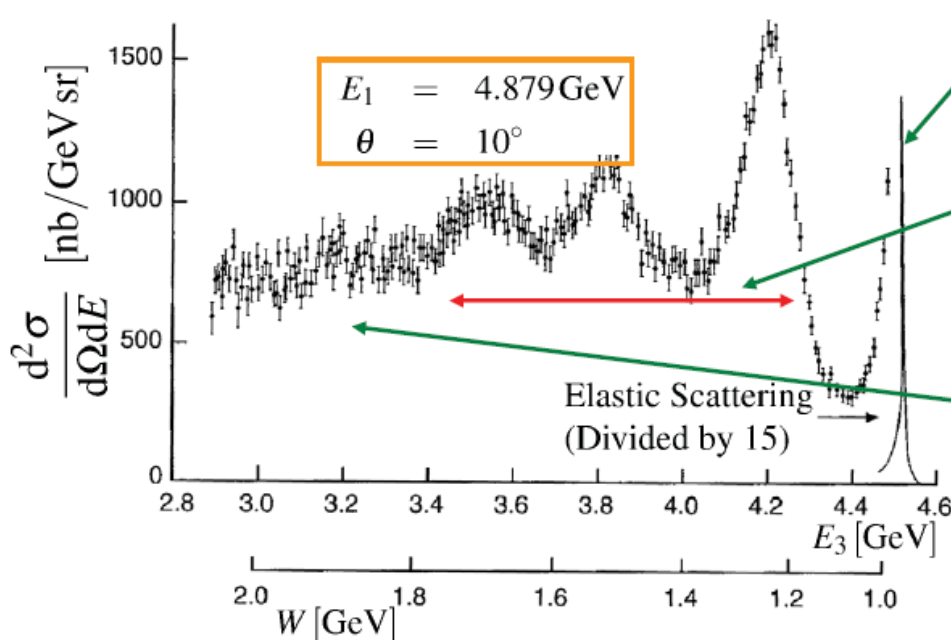

- **Elastic Scattering**
proton remains intact
 $W = M$
- **Inelastic Scattering**
produce "excited states" of proton e.g. $\Delta^+(1232)$
 $W = M_\Delta$
- **Deep Inelastic Scattering**
proton breaks up resulting in a many particle final state

DIS = large W

Inelastic Cross Section

- Repeat experiments at different angles/beam energies and determine q^2 dependence of elastic and inelastic cross-sections

M. Breidenbach et al.,
Phys. Rev. Lett. 23 (1969) 935

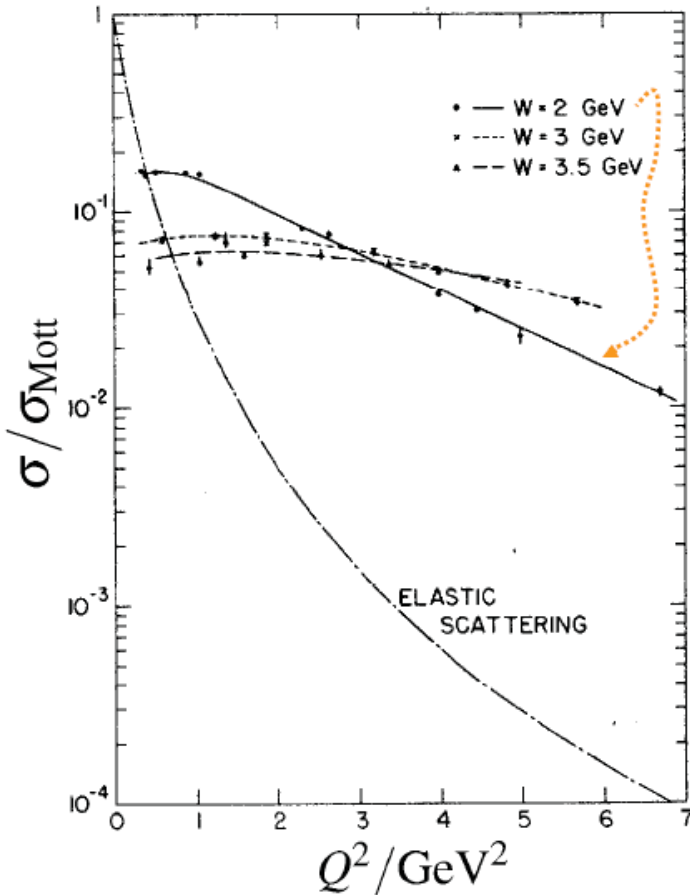

- Elastic scattering falls off rapidly with q^2 due to the proton not being point-like (i.e. form factors)
- Inelastic scattering cross sections only weakly dependent on q^2
- Deep Inelastic scattering cross sections almost independent of q^2 !

i.e. "Form factor" $\rightarrow 1$

→ Scattering from point-like objects within the proton !

Elastic → Inelastic Scattering

★ Recall: Elastic scattering

- **Only one independent variable.** In Lab. frame express differential cross section in terms of the electron scattering angle (Rosenbluth formula)

$$\frac{d\sigma}{d\Omega} = \frac{\alpha^2}{4E_1^2 \sin^4 \theta / 2} \frac{E_3}{E_1} \left(\frac{G_E^2 + \tau G_M^2}{(1 + \tau)} \cos^2 \frac{\theta}{2} + 2\tau G_M^2 \sin^2 \frac{\theta}{2} \right) \quad \tau = \frac{Q^2}{4M^2}$$

Note: here the energy of the scattered electron is determined by the angle.

- In terms of the Lorentz invariant kinematic variables can express this differential cross section in terms of Q^2

$$\frac{d\sigma}{dQ^2} = \frac{4\pi\alpha^2}{Q^4} \left[\frac{G_E^2 + \tau G_M^2}{(1 + \tau)} \left(1 - y - \frac{M^2 y^2}{Q^2} \right) + \frac{1}{2} y^2 G_M^2 \right]$$

which can be written as:

$$\frac{d\sigma}{dQ^2} = \frac{4\pi\alpha^2}{Q^4} \left[f_2(Q^2) \left(1 - y - \frac{M^2 y^2}{Q^2} \right) + \frac{1}{2} y^2 f_1(Q^2) \right]$$

★ Inelastic scattering

- For Deep Inelastic Scattering have **two independent variables**. Therefore need a double differential cross section

Deep Inelastic Scattering

- ★ It can be shown that the most general Lorentz Invariant expression for $e^-p \rightarrow e^-X$ inelastic scattering (via a single exchanged photon is):

$$\frac{d^2\sigma}{dx dQ^2} = \frac{4\pi\alpha^2}{Q^4} \left[\left(1 - y - \frac{M^2 y^2}{Q^2}\right) \frac{F_2(x, Q^2)}{x} + y^2 F_1(x, Q^2) \right] \quad (1) \quad \boxed{\text{INELASTIC SCATTERING}}$$

c.f. $\frac{d\sigma}{dQ^2} = \frac{4\pi\alpha^2}{Q^4} \left[\left(1 - y - \frac{M^2 y^2}{Q^2}\right) f_2(Q^2) + \frac{1}{2} y^2 f_1(Q^2) \right] \quad \boxed{\text{ELASTIC SCATTERING}}$

We will soon see how this connects to the quark model of the proton

- **NOTE:** The form factors have been replaced by the **STRUCTURE FUNCTIONS**

$$F_1(x, Q^2) \quad \text{and} \quad F_2(x, Q^2)$$

which are a function of x and Q^2 : can not be interpreted as the Fourier transforms of the charge and magnetic moment distributions. We shall soon see that they describe the **momentum distribution** of the quarks within the proton

- ★ In the limit of high energy (or more correctly $Q^2 \gg M^2 y^2$) eqn. (1) becomes:

$$\frac{d^2\sigma}{dx dQ^2} = \frac{4\pi\alpha^2}{Q^4} \left[(1 - y) \frac{F_2(x, Q^2)}{x} + y^2 F_1(x, Q^2) \right] \quad (2)$$

- In the Lab. frame it is convenient to express the cross section in terms of the angle, θ , and energy, E_3 , of the scattered electron - experimentally well measured.

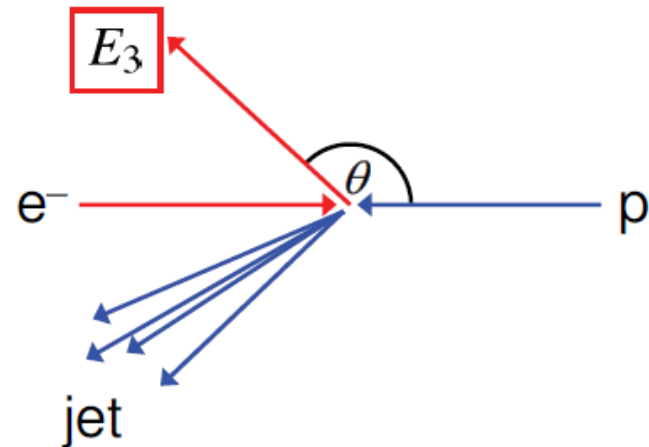
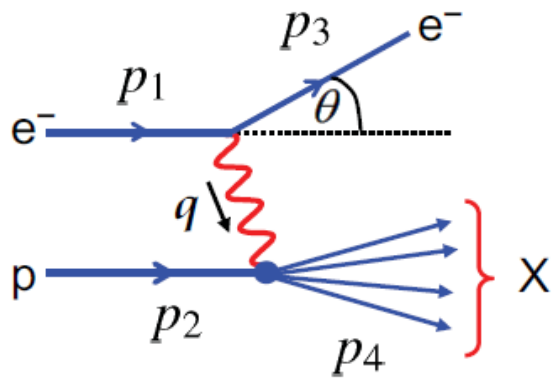

$$Q^2 = 4E_1 E_3 \sin^2 \theta / 2; \quad x = \frac{Q^2}{2M(E_1 - E_3)}; \quad y = 1 - \frac{E_3}{E_1}; \quad v = E_1 - E_3$$

- In the Lab. frame, Equation (2) becomes:

$$\frac{d^2\sigma}{dE_3 d\Omega} = \frac{\alpha^2}{4E_1^2 \sin^4 \theta / 2} \left[\frac{1}{v} F_2(x, Q^2) \cos^2 \frac{\theta}{2} + \frac{2}{M} F_1(x, Q^2) \sin^2 \frac{\theta}{2} \right] \quad (3)$$

Electromagnetic Structure Function

Pure Magnetic Structure Function

Measuring the Structure Functions

- ★ To determine $F_1(x, Q^2)$ and $F_2(x, Q^2)$ for a given x and Q^2 need measurements of the differential cross section at several different scattering angles and incoming electron beam energies

Example: electron-proton scattering F_2 vs. Q^2 at fixed x

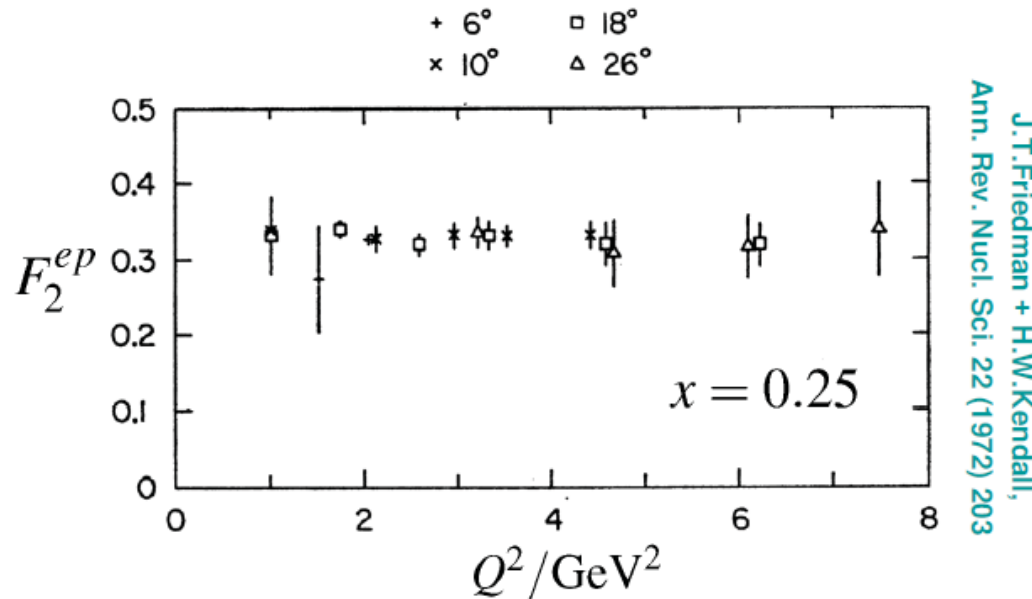

- ♦ Experimentally it is observed that both F_1 and F_2 are (almost) independent of Q^2

Bjorken Scaling and the Callan-Gross Relation

- ★ The near (see later) independence of the structure functions on Q^2 is known as **Bjorken Scaling**, i.e.

$$F_1(x, Q^2) \rightarrow F_1(x) \quad F_2(x, Q^2) \rightarrow F_2(x)$$

- It is strongly suggestive of scattering from **point-like constituents** within the proton
- ★ It is also observed that $F_1(x)$ and $F_2(x)$ are not independent but satisfy the **Callan-Gross relation**

$$F_2(x) = 2xF_1(x)$$

- As we shall soon see this is exactly what is expected for scattering from **spin-half** quarks.
- **Note** if quarks were spin zero particles we would expect the purely magnetic structure function to be zero, i.e. $F_1(x) = 0$

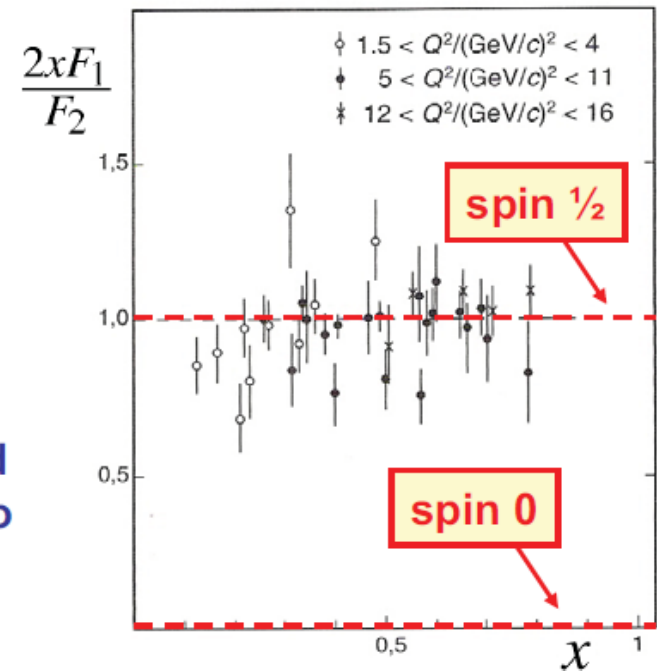

The Quark-Parton Model

- Before quarks and gluons were generally accepted Feynman proposed that the proton was made up of point-like constituents “**partons**”
- Both Bjorken Scaling and the Callan-Gross relationship can be explained by assuming that Deep Inelastic Scattering is dominated by the scattering of a single virtual photon from point-like spin-half constituents of the proton.

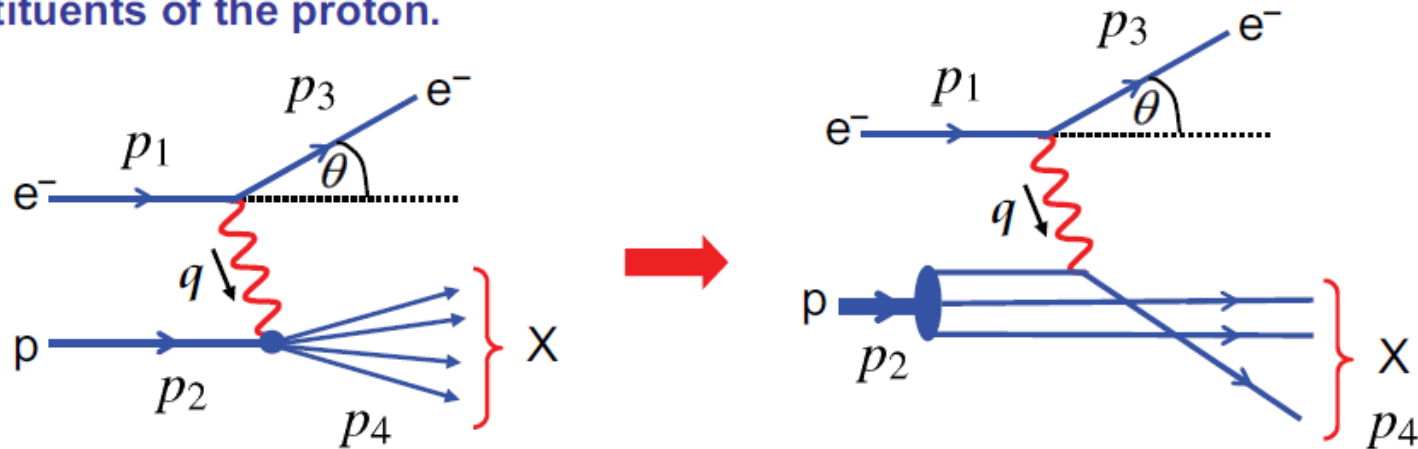

Scattering from a proton with structure functions

Scattering from a point-like quark within the proton

★ How do these two pictures of the interaction relate to each other?

- In the parton model the basic interaction is **ELASTIC** scattering from a “**quasi-free**” spin- $\frac{1}{2}$ quark in the proton, i.e. treat the quark as a free particle!
- The parton model is most easily formulated in a frame where the proton has very high energy, often referred to as the “**infinite momentum frame**”, where we can neglect the proton mass and $p_2 = (E_2, 0, 0, E_2)$
- In this frame can also neglect the mass of the quark and any momentum transverse to the direction of the proton.
- Let the quark carry a fraction ξ of the proton’s four-momentum.

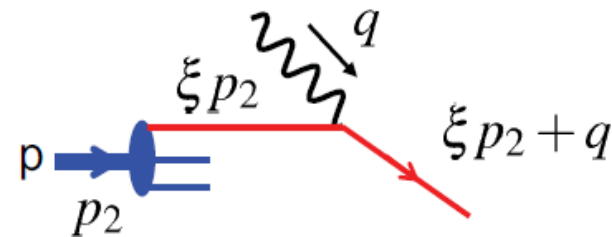
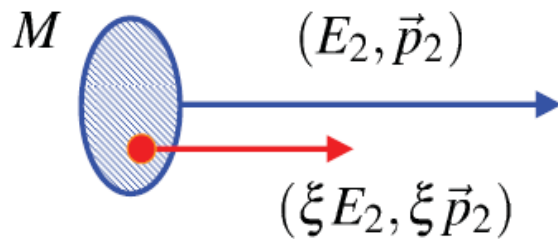

- After the interaction the struck quark’s four-momentum is $\xi p_2 + q$

$$(\xi p_2 + q)^2 = m_q^2 \approx 0 \quad \rightarrow \quad \cancel{\xi^2 p_2^2} + q^2 + 2\xi p_2 \cdot q = 0 \quad (\xi^2 p_2^2 = m_q^2 \approx 0)$$

$$\rightarrow \xi = \frac{Q^2}{2p_2 \cdot q} = x$$

Bjorken x can be identified as the fraction of the proton momentum carried by the struck quark (in a frame where the proton has very high energy)

- In terms of the proton momentum

$$s = (p_1 + p_2)^2 \simeq 2p_1 \cdot p_2 \quad y = \frac{p_2 \cdot q}{p_2 \cdot p_1} \quad x = \frac{Q^2}{2p_2 \cdot q}$$

- But for the underlying quark interaction

$$s^q = (p_1 + xp_2)^2 = 2xp_1 \cdot p_2 = xs$$

$$y_q = \frac{p_q \cdot q}{p_q \cdot p_1} = \frac{xp_2 \cdot q}{xp_2 \cdot p_1} = y$$

$$x_q = 1 \quad (\text{elastic, i.e. assume quark does not break up})$$

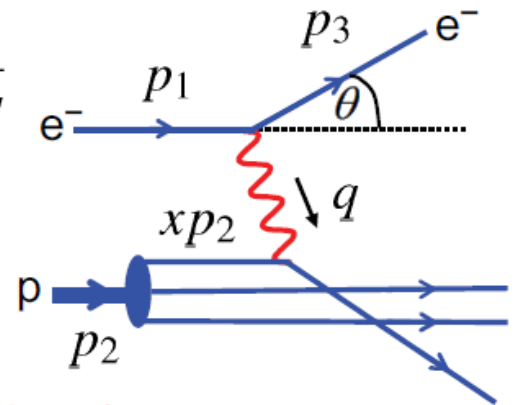

- Previously derived the Lorentz Invariant cross section for $e^- \mu^- \rightarrow e^- \mu^-$ elastic scattering in the ultra-relativistic limit .

Now apply this to $e^- q \rightarrow e^- q$

$$\frac{d\sigma}{dq^2} = \frac{2\pi\alpha^2 e_q^2}{q^4} \left[1 + \left(1 + \frac{q^2}{s_q} \right)^2 \right]$$

e_q is quark charge, i.e.
 $e_u = +2/3$; $e_d = -1/3$

- Using $-q^2 = Q^2 = (s_q - m^2)x_q y_q \quad \rightarrow \quad \frac{q^2}{s_q} = -y_q = -y$

$$\frac{d\sigma}{dQ^2} = \frac{2\pi\alpha^2 e_q^2}{Q^4} \left[1 + (1 - y)^2 \right]$$

$$\frac{d\sigma}{dQ^2} = \frac{4\pi\alpha^2 e_q^2}{Q^4} \left[(1-y) + \frac{y^2}{2} \right] \quad (3)$$

- ★ This is the expression for the differential cross-section for **elastic** e^-q scattering from a quark carrying a fraction x of the proton momentum.
- Now need to account for distribution of quark momenta within proton
- ★ Introduce parton distribution functions such that $q^P(x)dx$ is the number of quarks of type q within a proton with momenta between $x \rightarrow x + dx$
- Expected form of the parton distribution function ?

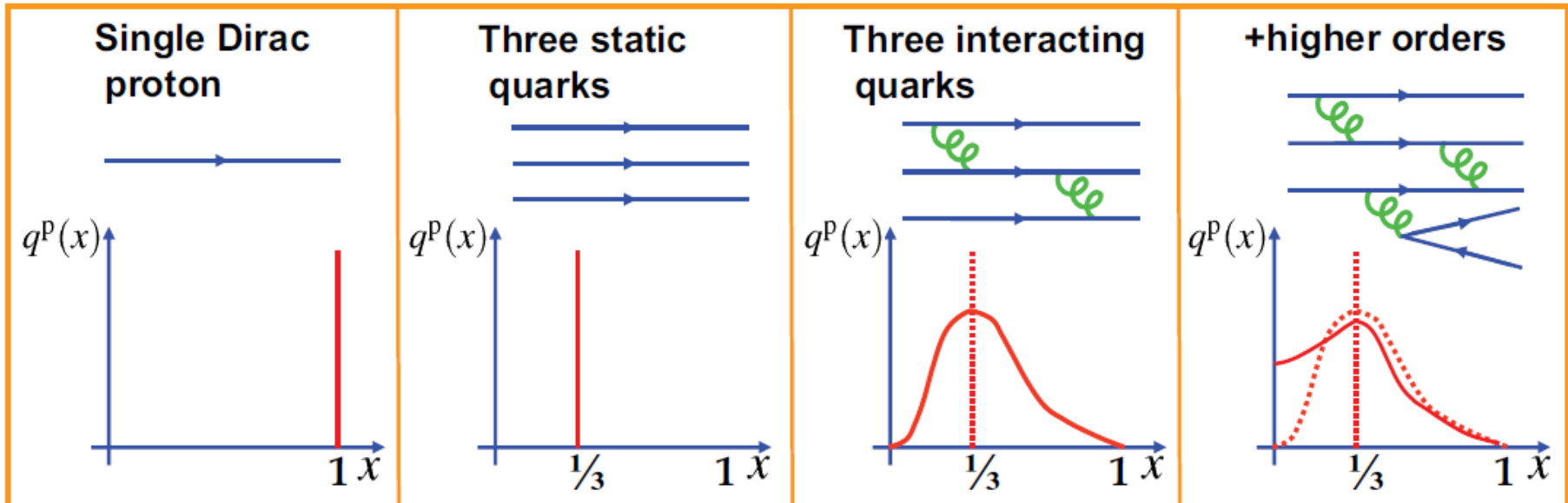

- ★ The cross section for scattering from a **particular quark type** within the proton which in the range $x \rightarrow x + dx$ is

$$\frac{d^2\sigma}{dQ^2} = \frac{4\pi\alpha^2}{Q^4} \left[(1-y) + \frac{y^2}{2} \right] \times e_q^2 q^p(x) dx$$

- ★ Summing over all types of quark within the proton gives the expression for the **electron-proton** scattering cross section

$$\frac{d^2\sigma^{ep}}{dx dQ^2} = \frac{4\pi\alpha^2}{Q^4} \left[(1-y) + \frac{y^2}{2} \right] \sum_q e_q^2 q^p(x) \quad (5)$$

- ★ Compare with the **electron-proton** scattering cross section in terms of structure functions (equation (2)):

$$\frac{d^2\sigma}{dx dQ^2} = \frac{4\pi\alpha^2}{Q^4} \left[(1-y) \frac{F_2(x, Q^2)}{x} + y^2 F_1(x, Q^2) \right] \quad (6)$$

- ★ By comparing (5) and (6) obtain the parton model prediction for the structure functions in the general L.I. form for the differential cross section

$$F_2^p(x, Q^2) = 2xF_1^p(x, Q^2) = x \sum_q e_q^2 q^p(x)$$



Can relate measured structure functions to the underlying quark distributions

The parton model predicts:

- **Bjorken Scaling** $F_1(x, Q^2) \rightarrow F_1(x)$ $F_2(x, Q^2) \rightarrow F_2(x)$
 - ★ Due to scattering from **point-like particles** within the proton
- **Callan-Gross Relation** $F_2(x) = 2xF_1(x)$
 - ★ Due to scattering from **spin half Dirac particles** where the magnetic moment is directly related to the charge; hence the “electro-magnetic” and “pure magnetic” terms are fixed with respect to each other.
- ★ At present parton distributions cannot be calculated from QCD
 - Can't use perturbation theory due to large coupling constant
- ★ Measurements of the structure functions enable us to determine the parton distribution functions !
- ★ For electron-proton scattering we have:

$$F_2^p(x) = x \sum_q e_q^2 q^p(x)$$

- Due to higher orders, the proton contains not only up and down quarks but also anti-up and anti-down quarks (will neglect the small contributions from heavier quarks)

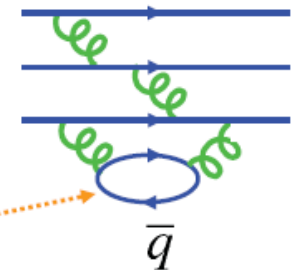

- For electron-proton scattering have:

$$F_2^{\text{ep}}(x) = x \sum_q e_q^2 q^{\text{p}}(x) = x \left(\frac{4}{9} u^{\text{p}}(x) + \frac{1}{9} d^{\text{p}}(x) + \frac{4}{9} \bar{u}^{\text{p}}(x) + \frac{1}{9} \bar{d}^{\text{p}}(x) \right)$$

- For electron-neutron scattering have:

$$F_2^{\text{en}}(x) = x \sum_q e_q^2 q^{\text{n}}(x) = x \left(\frac{4}{9} u^{\text{n}}(x) + \frac{1}{9} d^{\text{n}}(x) + \frac{4}{9} \bar{u}^{\text{n}}(x) + \frac{1}{9} \bar{d}^{\text{n}}(x) \right)$$

- ★ Now assume “isospin symmetry”, i.e. that the neutron (ddu) is the same as a proton (uud) with up and down quarks interchanged, i.e.

$$d^{\text{n}}(x) = u^{\text{p}}(x); \quad u^{\text{n}}(x) = d^{\text{p}}(x)$$

and define the neutron distributions functions in terms of those of the proton

$$\begin{aligned} u(x) &\equiv u^{\text{p}}(x) = d^{\text{n}}(x); & d(x) &\equiv d^{\text{p}}(x) = u^{\text{n}}(x) \\ \bar{u}(x) &\equiv \bar{u}^{\text{p}}(x) = \bar{d}^{\text{n}}(x); & \bar{d}(x) &\equiv \bar{d}^{\text{p}}(x) = \bar{u}^{\text{n}}(x) \end{aligned}$$

giving:

$$F_2^{\text{ep}}(x) = 2xF_1^{\text{ep}}(x) = x \left(\frac{4}{9} u(x) + \frac{1}{9} d(x) + \frac{4}{9} \bar{u}(x) + \frac{1}{9} \bar{d}(x) \right) \quad (7)$$

$$F_2^{\text{en}}(x) = 2xF_1^{\text{en}}(x) = x \left(\frac{4}{9} d(x) + \frac{1}{9} u(x) + \frac{4}{9} \bar{d}(x) + \frac{1}{9} \bar{u}(x) \right) \quad (8)$$

- **Integrating (7) and (8) :**

$$\int_0^1 F_2^{\text{ep}}(x) dx = \int_0^1 x \left(\frac{4}{9} [u(x) + \bar{u}(x)] + \frac{1}{9} [d(x) + \bar{d}(x)] \right) dx = \frac{4}{9} f_u + \frac{1}{9} f_d$$

$$\int_0^1 F_2^{\text{en}}(x) dx = \int_0^1 x \left(\frac{4}{9} [d(x) + \bar{d}(x)] + \frac{1}{9} [u(x) + \bar{u}(x)] \right) dx = \frac{4}{9} f_d + \frac{1}{9} f_u$$

- ★ $f_u = \int_0^1 [xu(x) + x\bar{u}(x)] dx$ **is the fraction of the proton momentum carried by the up and anti-up quarks**

Experimentally

$$\int F_2^{\text{ep}}(x) dx \approx 0.18$$

$$\int F_2^{\text{en}}(x) dx \approx 0.12$$

➔ $f_u \approx 0.36 \quad f_d \approx 0.18$

- ★ **In the proton, as expected, the up quarks carry twice the momentum of the down quarks**
- ★ **The quarks carry just over 50 % of the total proton momentum. The rest is carried by gluons (which being neutral doesn't contribute to **electron-nucleon** scattering).**

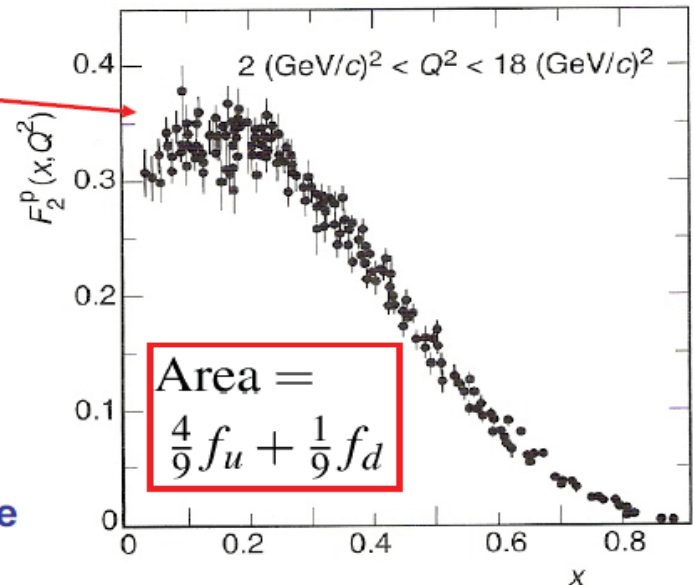

Valence and Sea Quarks

- As we are beginning to see the proton is complex...

- The parton distribution function $u^p(x) = u(x)$ includes contributions from the “valence” quarks and the virtual quarks produced by gluons: the “sea”

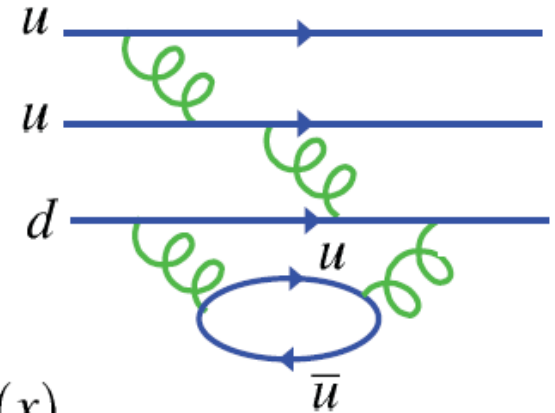

- Resolving into valence and sea contributions:

$$u(x) = u_V(x) + u_S(x) \quad d(x) = d_V(x) + d_S(x)$$

$$\bar{u}(x) = \bar{u}_S(x) \quad \bar{d}(x) = \bar{d}_S(x)$$

- The proton contains two valence up quarks and one valence down quark and would expect:

$$\int_0^1 u_V(x) dx = 2 \quad \int_0^1 d_V(x) dx = 1$$

- But no *a priori* expectation for the total number of sea quarks !
- But sea quarks arise from gluon quark/anti-quark pair production and with $m_u = m_d$ it is reasonable to expect

$$u_S(x) = d_S(x) = \bar{u}_S(x) = \bar{d}_S(x) = S(x)$$

- With these relations (7) and (8) become

$$F_2^{\text{ep}}(x) = x \left(\frac{4}{9} u_V(x) + \frac{1}{9} d_V(x) + \frac{10}{9} S(x) \right) \quad F_2^{\text{en}}(x) = x \left(\frac{4}{9} d_V(x) + \frac{1}{9} u_V(x) + \frac{10}{9} S(x) \right)$$

Giving the ratio

$$\frac{F_2^{\text{en}}(x)}{F_2^{\text{ep}}(x)} = \frac{4d_V(x) + u_V(x) + 10S(x)}{4u_V(x) + d_V(x) + 10S(x)}$$

- The sea component arises from processes such as $g \rightarrow \bar{u}u$. Due to the $1/q^2$ dependence of the gluon propagator, much more likely to produce low energy gluons. Expect the sea to comprise of **low energy** q/\bar{q}
- Therefore at low x expect the sea to dominate:

$$\frac{F_2^{\text{en}}(x)}{F_2^{\text{ep}}(x)} \rightarrow 1 \quad \text{as } x \rightarrow 0$$

Observed experimentally

- At high x expect the sea contribution to be small

$$\frac{F_2^{\text{en}}(x)}{F_2^{\text{ep}}(x)} \rightarrow \frac{4d_V(x) + u_V(x)}{4u_V(x) + d_V(x)} \quad \text{as } x \rightarrow 1$$

Note: $u_V = 2d_V$ would give ratio **2/3** as $x \rightarrow 1$

Experimentally $F_2^{\text{en}}(x)/F_2^{\text{ep}}(x) \rightarrow 1/4$ as $x \rightarrow 1$

$$\rightarrow d(x)/u(x) \rightarrow 0 \quad \text{as } x \rightarrow 1$$

This behaviour is not understood.

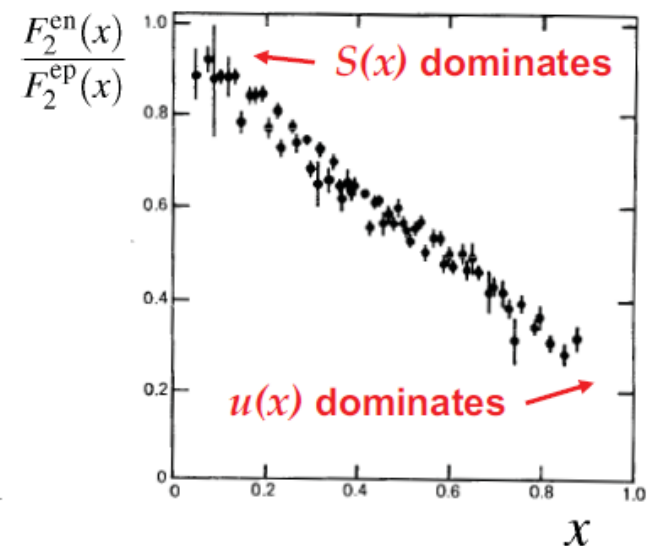

Parton Distribution Functions

- Ultimately the parton distribution functions are obtained from a fit to all experimental data including neutrino scattering
 - Hadron-hadron collisions give information on gluon pdf $g(x)$

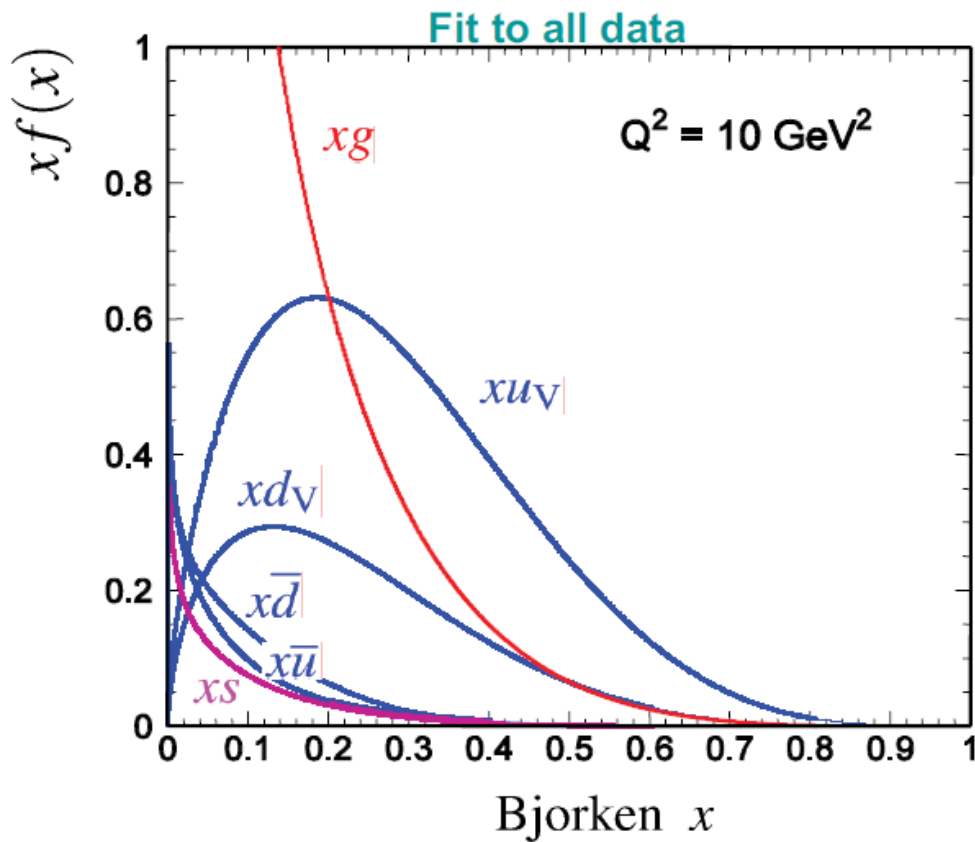

Note:

- Apart from at large x

$$u_V(x) \approx 2d_V(x)$$
- For $x < 0.2$

gluons dominate
- In fits to data assume

$$u_s(x) = \bar{u}(x)$$
- $\bar{d}(x) > \bar{u}(x)$

not understood -
exclusion principle?
- Small strange quark component $s(x)$

Scaling Violations

- In last 40 years, experiments have probed the proton with virtual photons of ever increasing energy
- Non-point like nature of the scattering becomes apparent when $\lambda_\gamma \sim$ size of scattering centre

$$\lambda_\gamma = \frac{h}{|\vec{q}|} \sim \frac{1 \text{ GeV fm}}{|\vec{q}|(\text{GeV})}$$

- Scattering from point-like quarks gives rise to **Bjorken scaling**: no q^2 cross section dependence
- IF quarks were not point-like, at high q^2 (when the wavelength of the virtual photon \sim size of quark) would observe rapid decrease in cross section with increasing q^2 .
- To search for quark sub-structure want to go to highest q^2

HERA

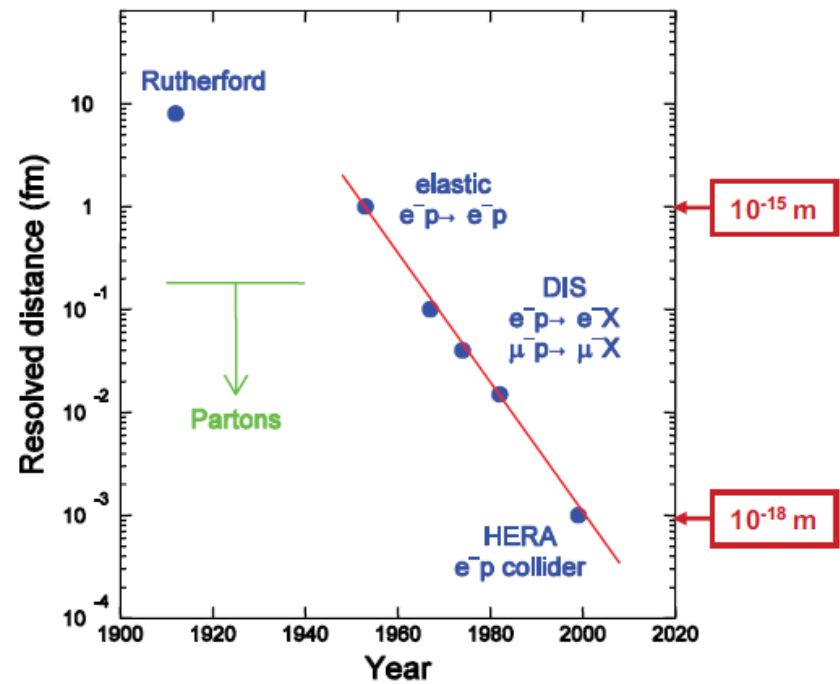
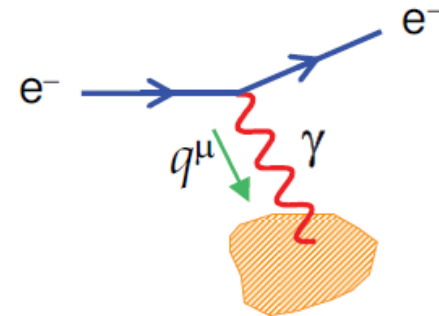

HERA $e^\pm p$ Collider: 1991 - 2007

★ DESY (Deutsches Elektronen-Synchrotron) Laboratory, Hamburg, Germany

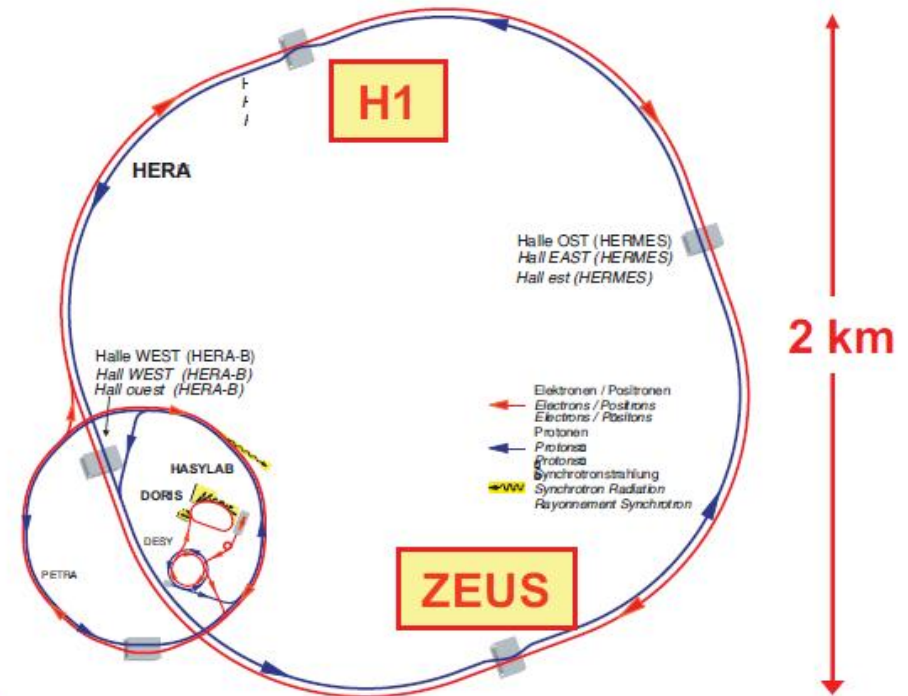

★ Two large experiments : H1 and ZEUS

★ Probe proton at very high Q^2 and very low x

Example of a High Q^2 Event in H1

* Event kinematics determined from electron angle and energy

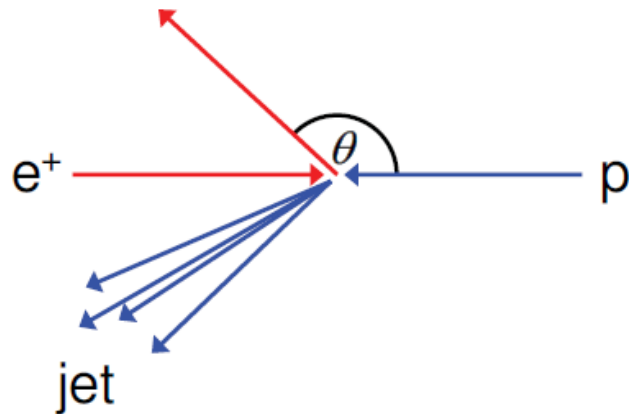

* Also measure hadronic system (although not as precisely) - gives some redundancy

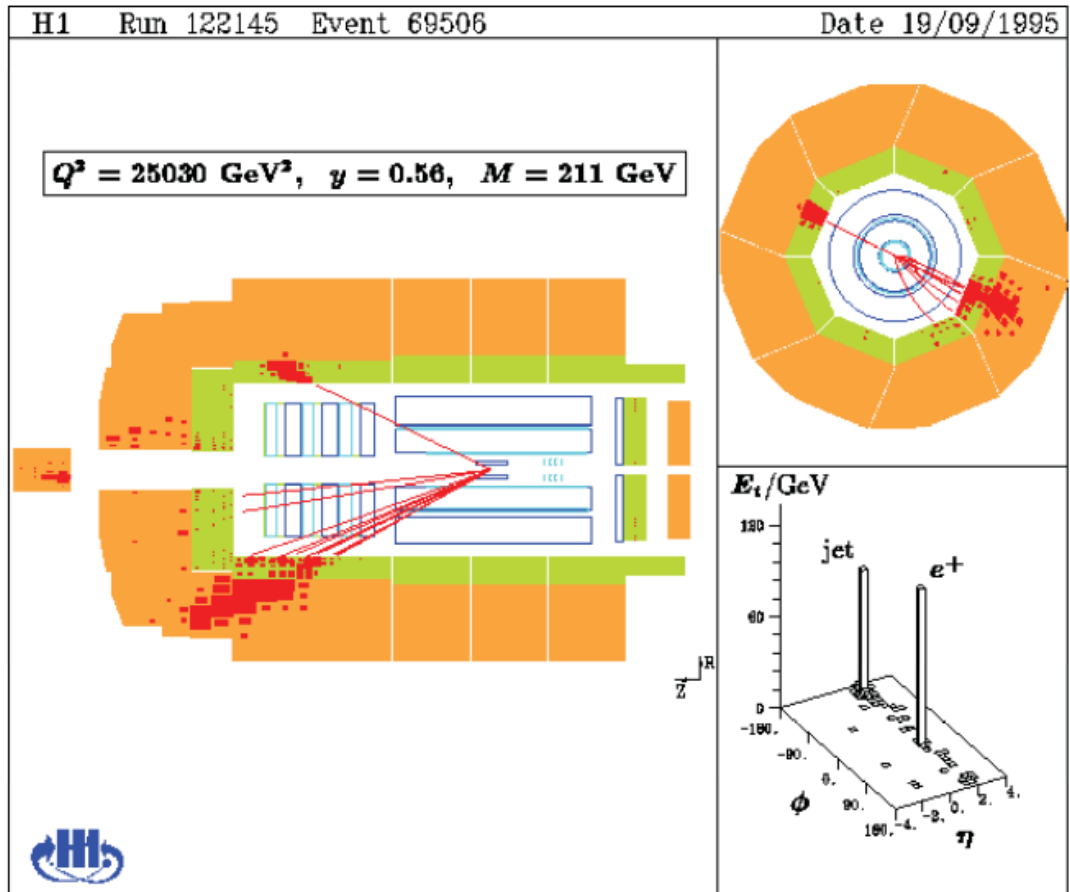

$F_2(x, Q^2)$ Results

- ★ No evidence of rapid decrease of cross section at highest Q^2

→ $R_{\text{quark}} < 10^{-18} \text{ m}$

- ★ For $x > 0.05$, only weak dependence of F_2 on Q^2 : consistent with the expectation from the quark-parton model
- ★ But observe clear scaling violations, particularly at low x

$$F_2(x, Q^2) \neq F_2(x)$$

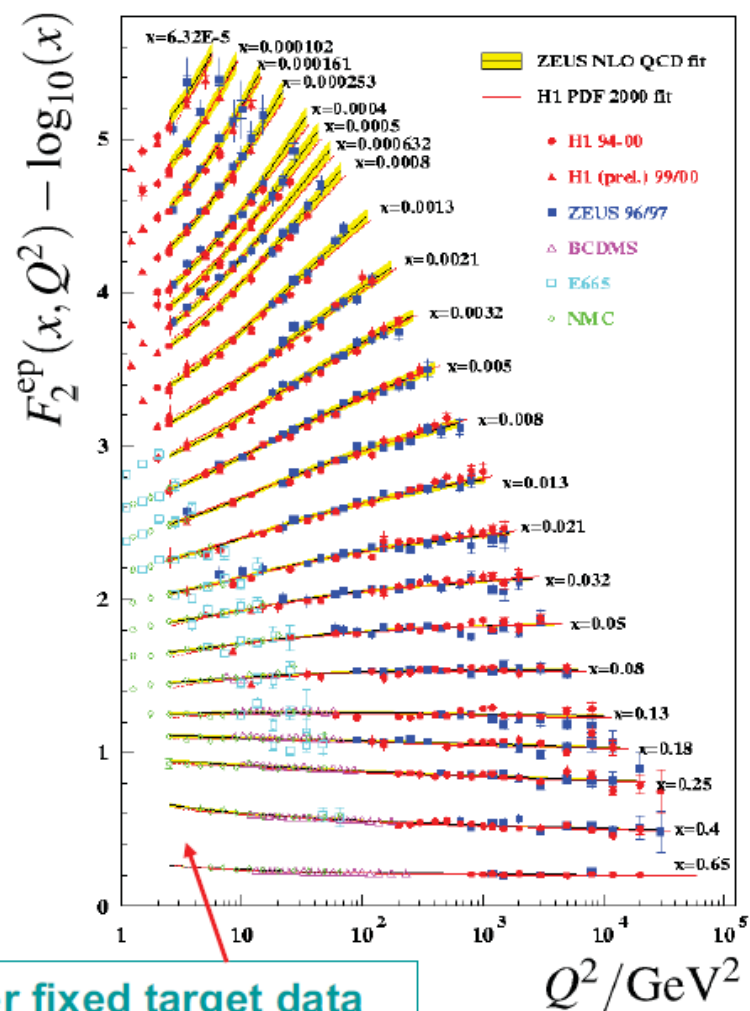

Origin of Scaling Violations

- ★ Observe “small” deviations from **exact Bjorken scaling** $F_2(x) \rightarrow F_2(x, Q^2)$

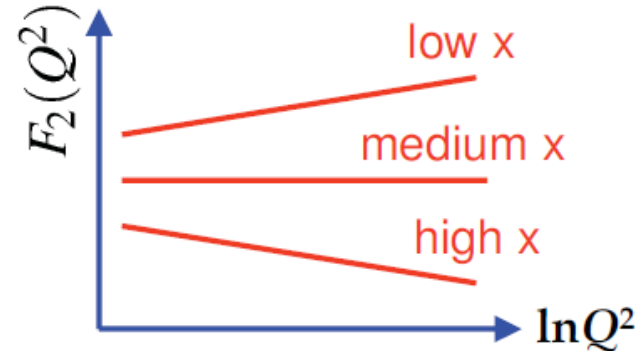
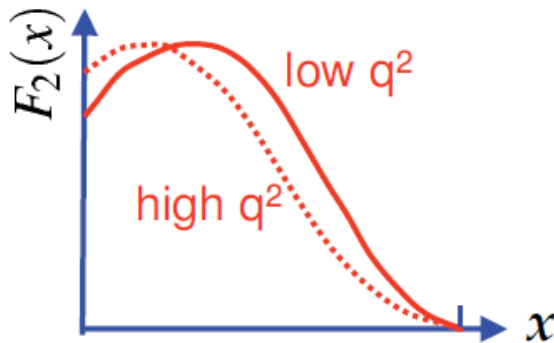

- ★ At high Q^2 observe more low x quarks
- ★ “Explanation”: at high Q^2 (shorter wave-length) resolve finer structure: i.e. reveal quark is sharing momentum with gluons. At higher Q^2 expect to “see” more low x quarks

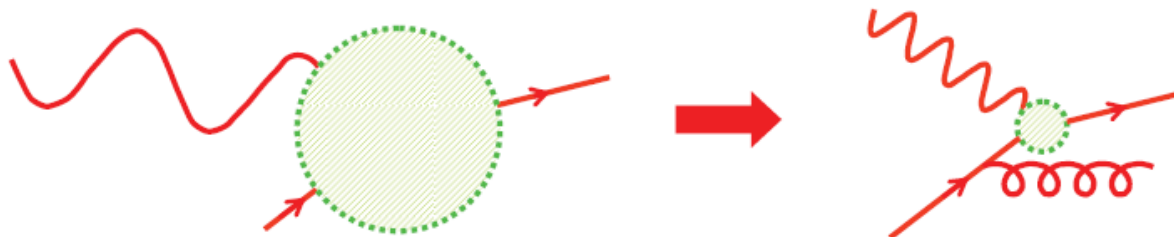

- ★ QCD cannot predict the x dependence of $F_2(x, Q^2)$

★ But QCD can predict the Q^2 dependence of $F_2(x, Q^2)$

Proton-proton collisions at the LHC

- ★ Measurements of structure functions not only provide a powerful test of QCD, the **parton distribution functions** are essential for the calculation of cross sections at pp and $p\bar{p}$ colliders.
- **Example:** Higgs production at the Large Hadron Collider **LHC** (2009-)
 - The LHC will collide 7 TeV protons on 7 TeV protons
 - However underlying collisions are between partons
 - Higgs production the LHC dominated by “**gluon-gluon fusion**”

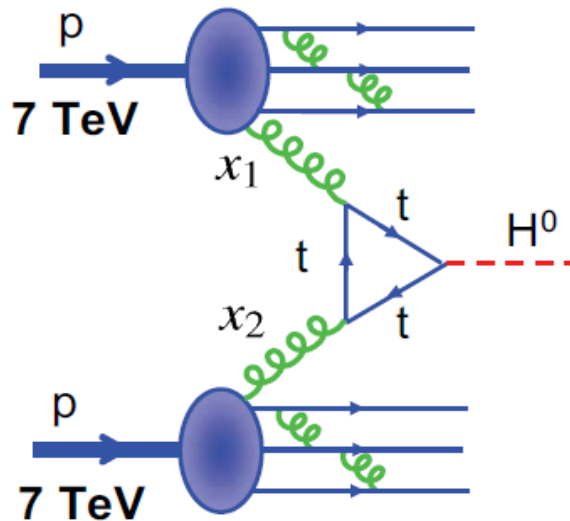

- Cross section depends on gluon PDFs

$$\sigma(pp \rightarrow HX) \sim \int_0^1 \int_0^1 g(x_1)g(x_2)\sigma(gg \rightarrow H)dx_1dx_2$$

- Uncertainty in gluon PDFs lead to a $\pm 5\%$ uncertainty in Higgs production cross section
- Prior to HERA data uncertainty was $\pm 25\%$

Summary

- ♦ At **very high** electron energies $\lambda \ll r_p$:
the proton appears to be a sea of quarks and gluons.
- ♦ Deep Inelastic Scattering = Elastic scattering from the quasi-free constituent quarks

⇒ Bjorken Scaling $F_1(x, Q^2) \rightarrow F_1(x)$

⇒ Callan-Gross $F_2(x) = 2xF_1(x)$

point-like scattering

Scattering from spin-1/2

- ♦ Describe scattering in terms of parton distribution functions $u(x), d(x), \dots$ which describe momentum distribution inside a nucleon
- ♦ The proton is much more complex than just uud - sea of anti-quarks/gluons
- ♦ Quarks carry only 50 % of the protons momentum - the rest is due to low energy gluons
- ♦ We will come back to this topic when we discuss neutrino scattering...

